

100 Years of Excellence



and Our Journey Continues



Joseph
Scanlan

Adam
Scanlan

Tim
Scanlan

Russell
Scanlan

Chenoa
Scanlan

Ron
Peick

As we celebrate our 100th anniversary, we want to thank you, our customer for allowing us to serve you on our journey.

My grandfather, Dennis R. Scanlan started this company in 1921 – introducing non-rustable steel (now known as stainless steel) surgical instruments. His first customers were the Mayo brothers ...he worked hand-in-hand with Charlie and Will to develop the original Mayo Scissors.

In those early years, working closely with surgeons, he gained an appreciation for the importance of high quality, reliable and durable instruments as well as the impact they had on surgical procedures. It was at this time my grandfather dedicated this company to make the very best surgical instrumentation available. In later years, this commitment was carried on by my father, D. R. Scanlan Jr., and today, the Scanlan Family (now in its fourth generation) continues its dedication to providing you with the highest quality, precision surgical products.

Today each instrument continues to be handmade (by experienced artisans) using the finest materials and we are honored that Scanlan products are in hospitals around the world helping to save lives.

Our anniversary slogan, “100 Years of Excellence ... and Our Journey Continues” really captures our ongoing spirit and excitement for the future. In the years ahead, we will continue to listen and serve you as personally as we have since our inception in 1921.

This catalog is a collection of our current, precision instruments and single-use products which cover a wide variety of surgical specialties. However, even as you are reading this, we are designing and refining more unique and innovative products to serve you ...and, ultimately, your patients.

Sincerely,

Timothy M. Scanlan
President
Chief Executive Officer

1921

Dennis R. Scanlan, Sr.

Scanlan's dedication to surgery began with Dennis Scanlan, Sr. in 1921! He attended meetings and supported the needs of surgical professionals with the design & manufacturing of the highest quality surgical instruments. These instruments were all manufactured with a revolutionary new material called "non-rustable" steel (stainless steel) which he introduced to the United States.



1921

Dennis R. Scanlan, Sr. - manager and promoter of speed skater Bobby McLean (shown above), and figure skater Sonja Henie... discovered Swedish non-rustable steel (stainless steel) which was ideal for surgical instrumentation.



1923

Dennis R. Scanlan, Sr. opens the first corporate office located at 516 5th Avenue, New York.





*Surgical Instruments
Made in Sweden*

Stille-Scanlan Company

Incorporated

*Factory
Stockholm Sweden*

Surgical Instruments Manufacturers

522 Fifth Ave

New York

*From D. R. Scanlan
at the Factory
Stockholm Sweden*

Stockholm the 8/3 1923.

To Doctor William G. Mayo,
Rochester, Minnesota.

My dear Doctor Mayo,

I thought I would have the pleasure of meeting You here in Stockholm this year as on several different occasions the local news papers had published an article that You were coming to Sweden sometime during the month of July but on my inquire at the Foreign Office they informed me they had no informations on this matter.

I am spending the summer here at our factory perfecting a few new models, which I will have with me at the clinic congress in Chicago this winter. I am mailing under separate cover 2 pair scissors, which are an exact duplicate of Your scissors, that the operating room sister gave me upon my visit to Rochester. These scissors are made out of the new non rustable steel, which is far superior than the ordinary carbon steel for the surgical instruments, as it retains the cutting edge longer and it is non corrosive.

We have increased the capacity of our factory nearly five times its previous size and it is our intention to go after the world's trade in surgical instruments.

Hoping to have the pleasure of meeting You at the surgical congress in Chicago, I am

Yours truly

STILLE-SCANLAN CO.,

by: *D. R. Scanlan*

This letter from Dennis R. Scanlan, Sr. to William Mayo was found in the archives of the Mayo Clinic in Rochester, MN and presented to Scanlan International as part of a tribute to our 100 year anniversary.





1923

Early Scanlan exhibit displaying a wide variety of surgical instrumentation, designed for various surgical specialties.



1930

Dennis R. Scanlan, Sr., convinces Walter Chrysler to use stainless steel for the roof of the new Chrysler Building in New York.

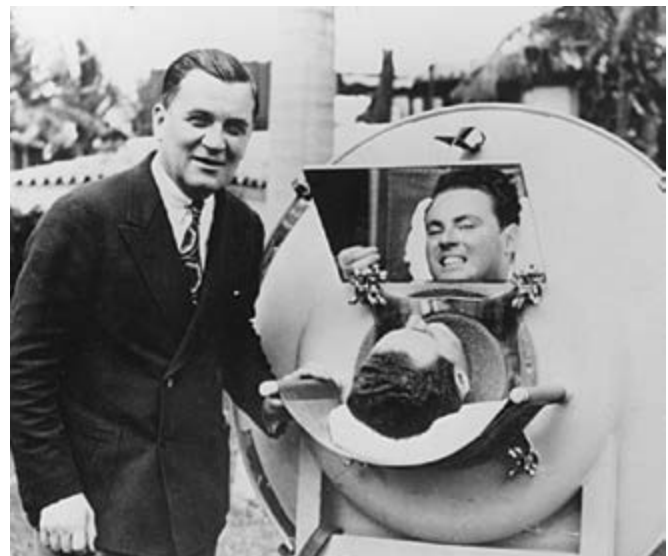

1937

Dennis R. Scanlan, Sr., invents the portable iron lung for use in the treatment of polio patients.



1923

Mayo Scissors

Dr. William J. Mayo works in collaboration with Dennis R. Scanlan, Sr., to design and manufacture the first Mayo surgical scissors.



1925

Crile Forceps

Dennis R. Scanlan, Sr., makes the first Crile forceps for Dr. George W. Crile at the Cleveland Clinic.



1935

Cushing Forceps

Dennis R. Scanlan, Sr., works in collaboration with Dr. Harvey Cushing to create neurosurgical instrumentation.



1946

Dennis R. Scanlan, Jr.

Dennis R. Scanlan, Jr., joined his father upon his return from England after serving with the 8th Air Force during World War II. Working with surgeons pioneering cardiac, vascular and solid organ transplantation, he changed the designs of surgical instruments to fit any size hand and produce positive patient outcomes.



1946

D.R. Scanlan, Jr., began working with his father to design and manufacture new surgical instruments, as well as single-use and instrument care products.

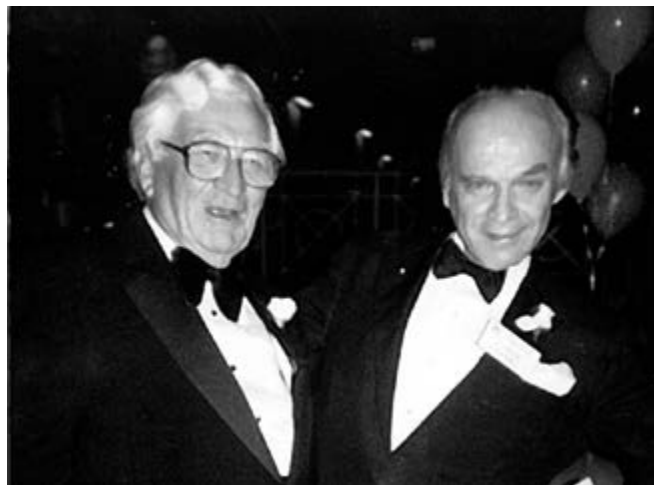

1970

D.R. Scanlan, Jr. worked with several leading cardiovascular surgeons in the development of new, revolutionary instrument designs - shown here with Dr. C. Walton Lillehei.





1960

Beall Scissors

Scanlan and Arthur C. Beall, Jr., MD worked together to design the Beall scissors which facilitates cutting at difficult angles encountered in coronary artery bypass surgery.



1960

Aortic Clamp

Scanlan International, in conjunction with Dr. Hunter, develop the first aorta clamp designed to facilitate multiple graft attachments without the necessity to reposition.



1961

SCANLAN® SURG-I-BAND®

SURG-I-BAND® Color Coding was invented, beginning a new era of single-use and instrument care products.





1968 Timothy M. Scanlan

Timothy M. Scanlan, President and Chief Executive Officer, leads the third and fourth generations of the Scanlan Family into the future. Aggressively pursuing excellence and the commitments of his father and grandfather, he continues to expand the company resources to meet the ever-changing needs of the medical community. Today, Scanlan International continues to handcraft each surgical instrument for cardiovascular, vascular and thoracic surgeons, as well as for the orthopedic, neuro, micro, and plastic surgical specialties.



1968
American College of Surgeons
(ACS Clinical Congress)



2016
American Association of Thoracic Surgeons
(AATS Clinical Congress)

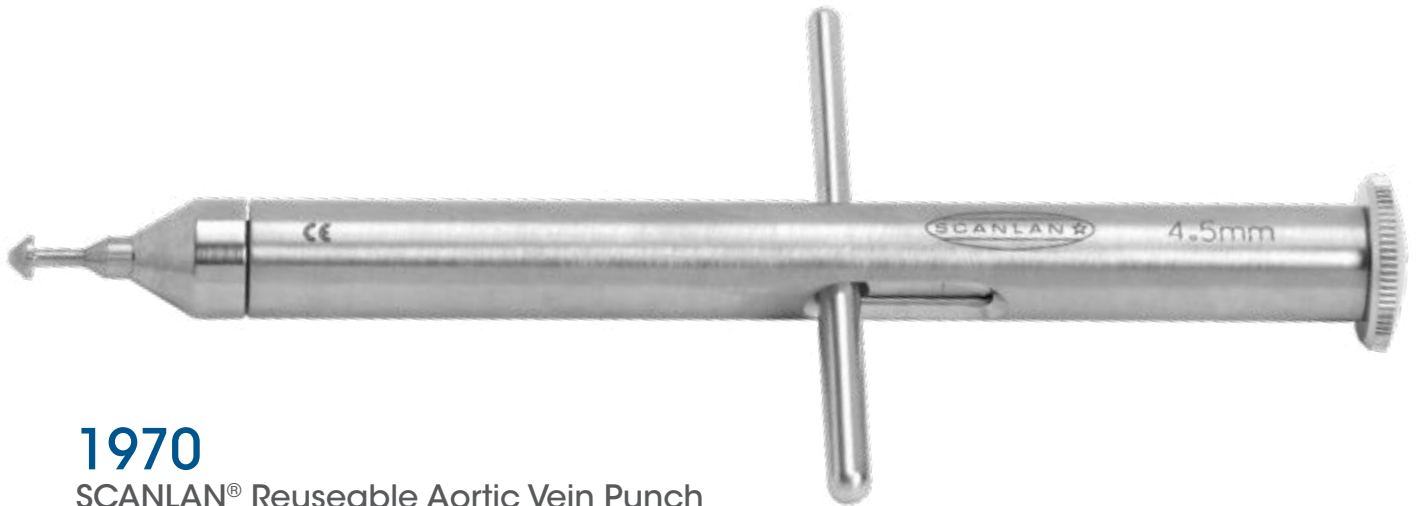

1970

SCANLAN® Reuseable Aortic Vein Punch

Scanlan International offers the world's medical community its latest invention, the new Aortic Vein Punch for use in coronary bypass.

1975
SCANLAN®
Diamond Dust™

Diamond Dust™ was developed to meet the need for an instrument tip surface that would provide surgeons with definite control without trauma to tissue or damage to needles.



1976

Brigid Scanlan Eiyneck

Brigid joined the company in 1976 and was a catalyst for the continued development of new and exciting surgical instrument designs. She worked closely with instrument artisans to ensure each handmade instrument was a statement of perfection. Over the years, Brigid's great vision helped to support surgeon and nurse organizations through scholarships to help further the education of young medical students. She also had a big heart and loved supporting hundreds of surgeons, nurses and O.R. professionals doing compassion surgery around the globe.



1977

Twin Cities AORN Chapter Meeting.



2008

Tim and Brigid inspecting new instruments.





1980

SCANLAN® Aorta / Vein Punch

Scanlan develops the world's first single-use aorta vein punch.



1987

SCANLAN® Super Cut™ Scissors

Scanlan introduces the Super Cut™ scissors offering a unique blade design which produces a razor sharp edge allowing surgeons to cut any tissue with a revolutionary degree of control and tactile response.





1997

SCANLAN® VATS and MIS Instrumentation

Working with world-renowned cardiovascular surgeons, Scanlan International begins to develop innovative designs and concepts for video-assisted thoracic surgery (VATS) and minimally-invasive surgical (MIS) procedures.





1999

SCANLAN® Neurosurgical Products

Scanlan International develops a new focus for neurosurgical products working with industry leading surgeons.





2000's Russell T. Scanlan

Russ, like Tim and Brigid grew up "in the business." ...marking the beginning of the fourth generation!

Over the years he has worn many hats in the company ... he is actively involved with the continued expansion and development of products for the operating room.



1995

Growing up in the family business, Russ learned to appreciate Scanlan's dedication to designing and manufacturing the highest quality surgical instrumentation.



2012

Demonstrating Scanlan's precision instrumentation at the American Association of Thoracic Surgeons (AATS) ...one of over 100 meetings we attend each year.



2005

SCANLAN® *LEGACY* Needle Holders and Forceps

SCANLAN® introduces *LEGACY* titanium instrumentation... with its unique blue and silver color. These instruments feature beautifully crafted extended knurling and the SCANLAN® Never Shear™ Dual Guide™ which prevents the tips of forceps from scissoring and prevents tissue shearing.





2007

SCANLAN® Continues to Expand its VATS/MIS Instrumentation

Scanlan continues to develop minimally invasive instruments to meet the needs of thoracic surgeons evolving from a conventional (open approach) to a thoracoscopic / minimally invasive approach. This evolution to video-assisted thoracic surgery (VATS) became a catalyst for a new generation of specialty surgical instrumentation.



2010

SCANLAN®

Chitwood Knot Pusher

Enables the surgeon to securely tie knots even in deep operative fields through small incisions.





2010

SCANLAN® Reliance Bulldog Clamp

The SCANLAN® Reliance Bulldog Clamp has been designed to provide secure, robust clamping pressure to assist in the temporary occlusion of vessels.

2012

SCANLAN® MEMORY Instruments

Scanlan Memory Instruments incorporate nitinol technology... Nitinol is a metal alloy which is flexible and has shape memory. This means that the nitinol portion of the instrument can be bent by the user to a desired curved shape for use. The instrument will return back to its original shape when exposed to a temperature of 60°C - 90°C (140° - 194°F).

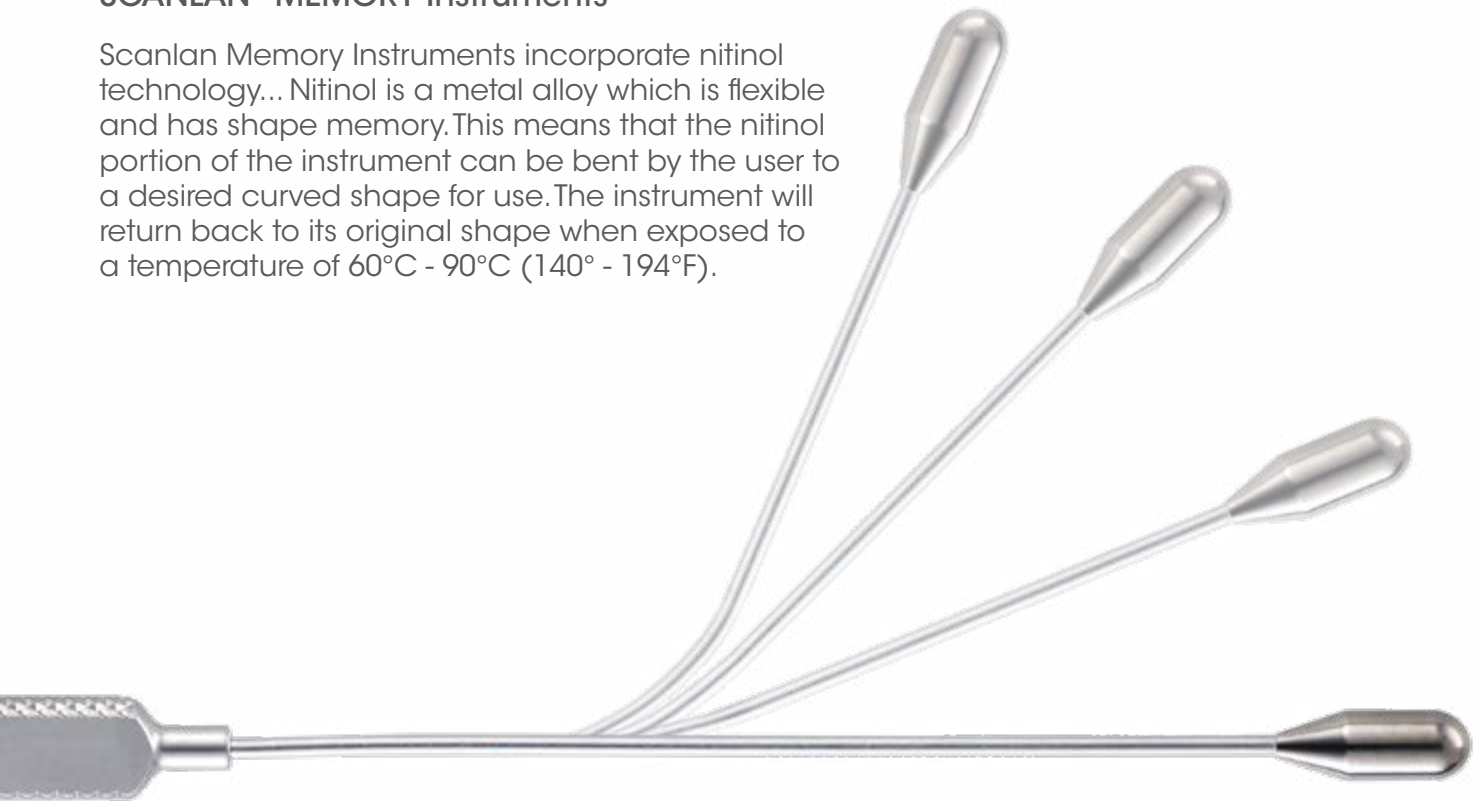



2018

SCANLAN® Super-Micro Fine Instruments

SCANLAN® Super-Micro Fine instrumentation is designed to meet the needs of all microsurgeons who work under a high power operating microscope or utilize surgical loupes to facilitate microvascular surgical technique by anastomosing small nerves and vessels.





2018

SCANLAN® LEGACY Instruments with SCAN-II® Handle Design

The SCAN-II® handle is a revolutionary design that features a flat surface for control with round knurled sides for a secured grip and the ability to roll the instrument during procedures.

2019

SCANLAN® M.D.® Retractor System

The SCANLAN® M.D.® Retractor System was designed to provide excellent visualization of the surgical field during pediatric heart surgery. This retractor system features the revolutionary Scan-Vu® radiolucent single-use arms which allow the surgeon a clear, unobstructed view of the patient's anatomy during Hybrid OR procedures.



2021

SCANLAN® Scanturian® Minimally Invasive Surgical Instruments

Scanlan introduces a new line of MIS Instruments designed to continue Scanlan's uncompromising commitment to developing the highest quality surgical instrumentation.







Giving Back to the Surgical Community



Scanlan Life Programs

Scanlan takes great pride in supporting surgeons, nurses and surgical teams who travel around the world in their quest to provide quality health care to others less fortunate. Through the years we have supported hundreds of surgeons and surgical teams who perform compassion surgery in countries where lifesaving surgeries are not an option. These donations of Scanlan surgical instrumentation support everything from heart surgeries to reconstructive surgeries ...allowing countless children and adults lead happy, normal lives.



Wet Lab Support

Scanlan is proud to support over 100 wet labs each year with complimentary surgical instrumentation. This allows surgeons to use the very best instruments during surgical simulation ranging from initial training ...to learning new complicated surgical techniques. Over the years we have supplied instruments to several surgical specialties including cardiovascular, thoracic, VATS, MIS, vascular, micro, neuro and more. We also send a team of instrumentation experts to help with all aspects - from setup and implementation of instruments to completion.



Scholarship Programs

Scanlan is proud to sponsor several scholarship programs designed to support up-and-coming surgeons and nurses.

These include...

- Scanlan Family Scholars-AATS Foundation, Summer Intern Scholarship
- D.R. Scanlan, Jr. Memorial AORN, Education Scholarship
- Scanlan Family-AWS AJS Best Paper Contest Sponsor
- WTS Brigid Scanlan Traveling Mentorship Award

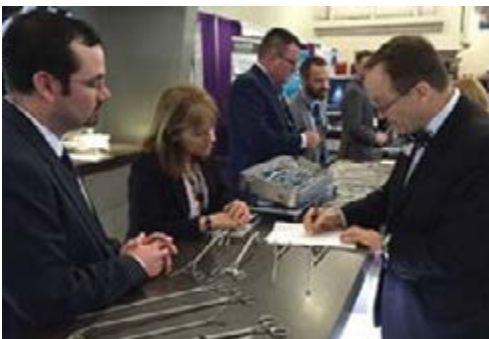

Surgical Conference Attendance and Support

Scanlan attends over 100 domestic and international meetings each year allowing us to stay close to surgeons and support their needs for new innovative designs to help advance surgical procedures. We also serve on association exhibitor committees to strengthen communication and enhance surgical association's success.



1. NEW
 Clamps 1.1
 Forceps 1.2
 Needle Holders 1.5
 Scissors 1.7
 Specialty 1.8
 VATS/MIS 1.9
 Scanturian® MIS Instruments 1.12



2. CLAMPS
Titanium
 Titanium Micro Vascular 2.1
 Titanium Medium Vascular 2.8
 Titanium Large Vascular 2.14
 Titanium Specialty 2.17
Stainless Steel
 Micro Vascular 2.18
 Medium Vascular 2.23
 Large Vascular 2.37
 Haemostats 2.44
 Specialty 2.54



3. FORCEPS
Titanium
 Titanium LEGACY Round Handle 3.2
 Titanium LEGACY Flat Handle 3.5
 Titanium LEGACY Bayonet Style 3.8
 Titanium Round Handle 3.9
 Titanium Flat Handle 3.14
Stainless Steel
 Round Handle 3.21
 Flat Handle — Fine 3.29
 Flat Handle — Fine to Medium 3.30
 Bayonet Style 3.39



4. NEEDLE HOLDERS
Titanium Spring Style
 Titanium LEGACY Round Handle 4.1
 Titanium LEGACY Flat Handle 4.5
 Titanium Round Handle 4.8
 Titanium Flat Handle 4.14
Titanium Ring Handle
 Titanium Ring Handle 4.19
Titanium Bayonet
 Titanium Bayonet Style 4.26
Stainless Steel Spring Style
 Spring Style Round Handle 4.27
 Spring Style Flat Handle 4.35
Stainless Steel Ring Handle
 Ring Handle 4.39
Stainless Steel Bayonet
 Bayonet Style 4.47



5. SCISSORS
 Spring Style 5.1
 Bayonet Style 5.21
 Ring Handle 5.25





6. SPECIALTY	
Reliance Bulldog Clamps.....	6.1
Reusable Temporary Occlusion Clips.....	6.4
Sundt™ Graduated Suction System.....	6.8
SCANLAN® Caliper / Knife Blade Tool.....	6.10
SCANLAN® MEMORY Instruments.....	6.11
Dilators and Vessel Probes.....	6.12
Chest Tube Passer.....	6.13
Phlebectomy Hooks.....	6.14
Valvulotomes.....	6.15
Aorta / Vein Punches (Re-useable).....	6.16
Hand Held Retractors.....	6.17
Retractors.....	6.20
Dissectors.....	6.28
Nerve Hooks & Probes.....	6.32
Plaque Removers.....	6.33
Instrument Sets.....	6.34
7. VATS / MIS	
Biopsy Forceps.....	7.2
Clamps.....	7.4
Scissors.....	7.25
Forceps.....	7.27
Needle Holders.....	7.30
Specialty.....	7.37
Suction Instruments.....	7.40
Dennis Rib Cutter.....	7.44
Periosteal Elevator.....	7.45
Stern™ Chest Tube Passer.....	7.46
Chitwood Suture Puller.....	7.47
8. MIS	
Scanturian® MIS Instruments.....	8.1
9. INSTRUMENT CARE	
Color Coding.....	9.1
Tracking and Tagging System.....	9.5
Autoclavable Pouch.....	9.9
Instrument Protectors.....	9.10
Sterilization Trays.....	9.12
10. SINGLE USE	
Surgical Skin Markers.....	10.1
Aorta / Vein Punches.....	10.2
Graft Markers.....	10.3
Vascular Tunneling.....	10.4
VASCU-STATT® Bulldog Clamp System.....	10.8
Silicone Loops.....	10.12
Clamp and Jaw Covers.....	10.13
Suture Boots.....	10.14
Suture Tags.....	10.14
Pin Protectors.....	10.15
Vein Holder.....	10.15
11. INDEX	
12. WARRANTY / CARE AND MAINTENANCE	



NEW PRODUCTS

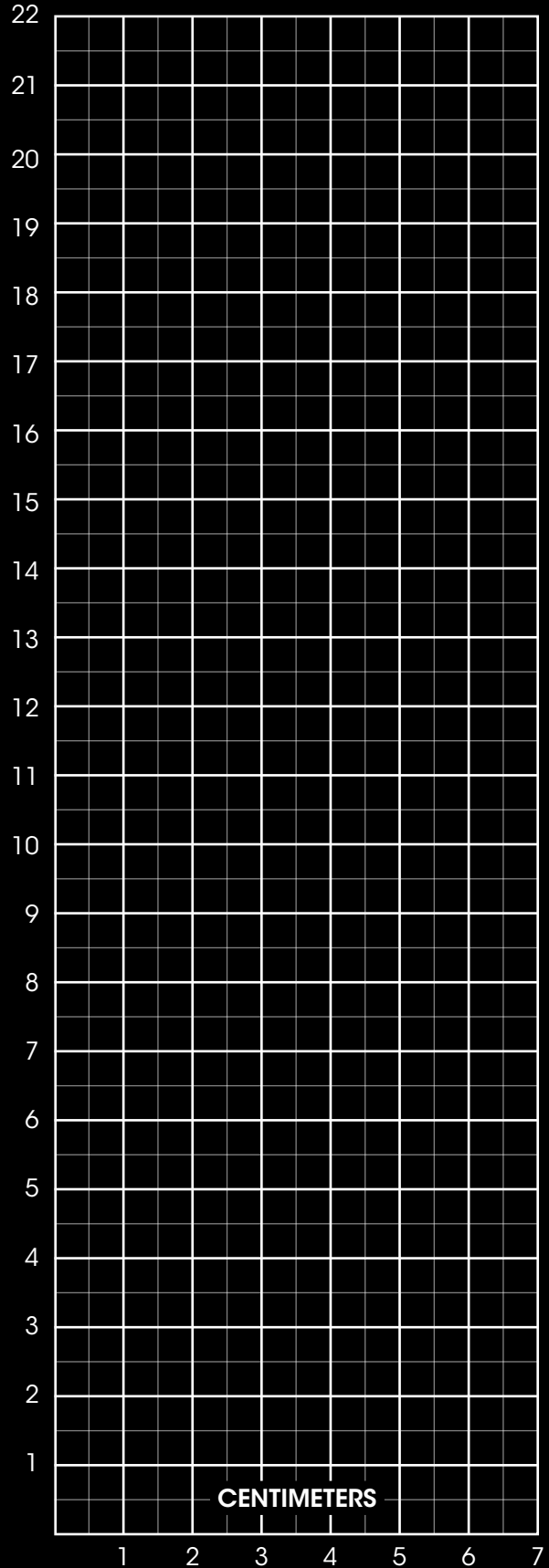
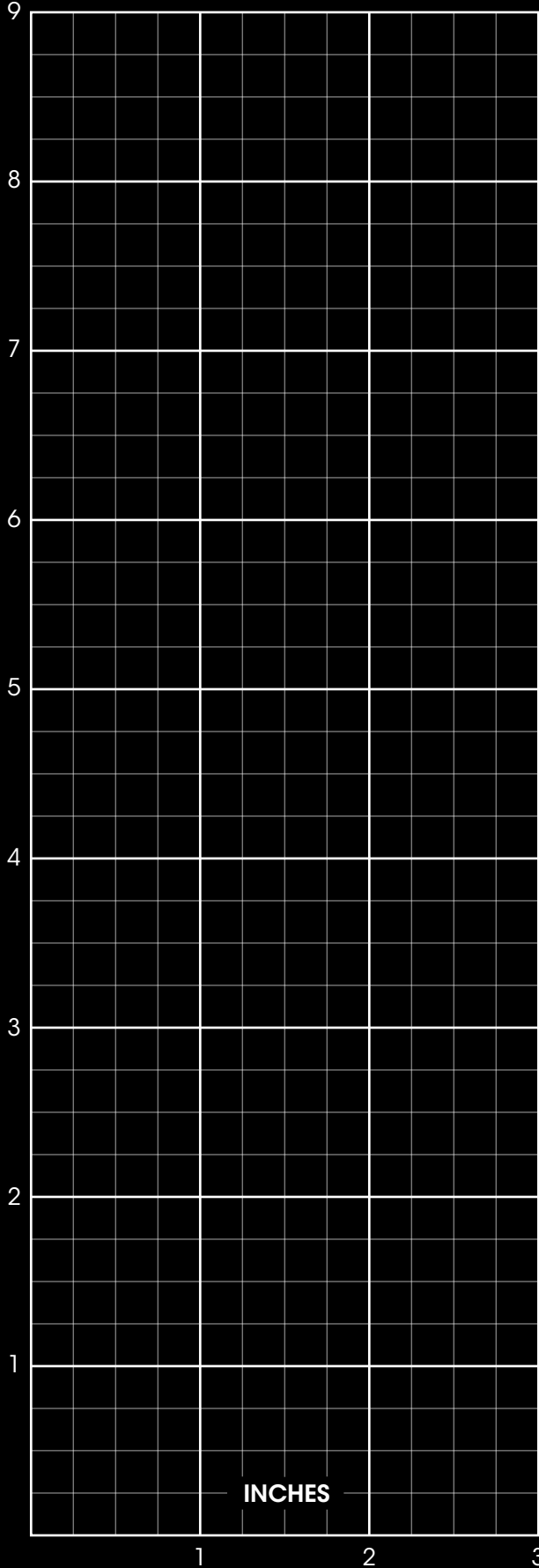

Micro Vascular Profunda Clamp

DeBaKey Jaws



NEW

SCANLAN®
Micro Vascular Clamp
Page 2.6

Profunda Clamp	
3003-617	5-1/4" (13.5 cm)

Micro Vascular Lambert-Kay Clamp

Angled Shanks

Cooley Jaws



NEW

SCANLAN®
Micro Vascular Clamp
Page 2.7

Lambert-Kay Clamp	
3003-59	4-1/2" (11 cm)



LEGACY Forceps with SCAN-II® Handle

The SCAN-II® Handle is a revolutionary design available in the LEGACY series that features a flat surface for control with round knurled sides for a secured grip and the ability to roll the instrument during procedures.



SCANLAN® LEGACY Forceps with SCAN-II® Handle

Platform Ring Tip
 Page 3.5



1.0 mm Straight	
3003-942	7-1/8" (18.1 cm)
3003-944	8-1/4" (21 cm)
3003-946	9" (23 cm)
3003-948	10" (25.4 cm)

**Platform
 DIAMOND DUST™ Tip**
 Page 3.5



0.5 mm Straight	
3003-962	7-1/8" (18.1 cm)
3003-964	8-1/4" (21 cm)
3003-966	9" (23 cm)
3003-968	10" (25.4 cm)

1.0 mm Straight	
3003-972	7-1/8" (18.1 cm)
3003-974	8-1/4" (21 cm)
3003-976	9" (23 cm)
3003-978	10" (25.4 cm)

DeBakey Tip
 Page 3.6



1.0 mm Straight	
3003-952	7-1/8" (18.1 cm)
3003-954	8-1/4" (21 cm)
3003-956	9" (23 cm)
3003-958	10" (25.4 cm)

1x2 Micro Teeth Tip
 Page 3.7



0.5 mm Straight	
3003-980	7-1/8" (18.1 cm)
3003-984	8-1/4" (21 cm)
3003-990	9" (23 cm)
3003-992	10" (25.4 cm)

1.0 mm Straight	
3003-988	8-1/4" (21 cm)
3003-994	9" (23 cm)
3003-996	10" (25.4 cm)

0.5 mm Curved	
3003-985	8-1/4" (21 cm)

0.5 mm Angled	
3003-986	8-1/4" (21 cm)

1.0 mm Angled	
3003-989	8-1/4" (21 cm)

LEGACY Bayonet Style Forceps with SCAN-II® Handle

The SCAN-II® Handle is a revolutionary design available in the LEGACY series that features a flat surface for control with round knurled sides for a secured grip and the ability to roll the instrument during procedures.



1x2 Micro Teeth Tip
 Page 3.8



0.5 mm Straight	
3003-820	8-3/4" (22 cm)



DeBakey Forceps with 1x2 Teeth



1x2 Multi Tooth Tip
 Page 3.16

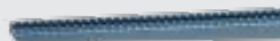

1.2 mm Straight	
3003-051	7-3/4" (19.5 cm)
3003-071	9-1/2" (24 cm)



Super-Micro Fine Forceps

SCANLAN® Super-Micro Fine Forceps are designed with a low profile tapered shank for improved visibility under the microscope. The high quality titanium makes the instrument light-weight, durable and non-magnetic to needles. The 0.3 mm DIAMOND DUST™ tip is ideal for picking up 9-0 suture (100 micron needles).



SCANLAN®
Super-Micro Fine Forceps
Round and Flat Handles



Round Handle
Page 3.10



0.3 mm Curved

3303-452	5" (12.7 cm)
-----------------	--------------

0.3 mm Straight

3303-470	7-1/4" (18.5 cm)
-----------------	------------------

0.3 mm Curved

3303-477	7-1/4" (18.5 cm)
-----------------	------------------



Flat Handle
Page 3.15



0.3 mm Straight

3303-410	5" (12.7 cm)
-----------------	--------------

3303-430	7-1/4" (18.5 cm)
-----------------	------------------

0.3 mm Angled

3303-434	7-1/4" (18.5 cm)
-----------------	------------------

LEGACY Needle Holders with SCAN-II® Handle

The SCAN-II® Handle is a revolutionary design available in the LEGACY series that features a flat surface for control with round knurled sides for a secured grip and the ability to roll the instrument during procedures.



SCANLAN® LEGACY Needle Holders with SCAN-II® Handle

Page 4.5

Page 4.6

Page 4.7



7-0 Suture Size	
3003-372	7" (18 cm)
3003-374	8" (20 cm)
3003-376	9" (23 cm)
3003-378	10" (25.4 cm)

5-0 Suture Size	
3003-382	7" (18 cm)
3003-384	8" (20 cm)
3003-386	9" (23 cm)
3003-388	10" (25.4 cm)

3-0 Suture Size	
3003-332	7" (18 cm)
3003-334	8" (20 cm)
3003-336	9" (23 cm)
3003-338	10" (25.4 cm)

NEW

Super-Micro Fine Needle Holders

SCANLAN® Super-Micro Fine Needle Holders are designed with a low profile tapered shank for improved visibility under the microscope. The high quality titanium makes the instrument light-weight, durable and non-magnetic to needles. The 0.3 mm DIAMOND DUST™ tip is ideal for picking up 9-0 suture (100 micron needles).



SCANLAN®
Super-Micro Fine Needle Holders
 Round and Flat Handles

Round Handle
 Page 4.10

Flat Handle
 Page 4.14

Curved

Straight

Straight



9-0 Suture	
3303-646	5" (12.7 cm)

9-0 Suture	
3303-664	7-1/4" (18.5 cm)

9-0 Suture	
3303-622	7-1/4" (18.5 cm)

Premier™

Spring Style Scissors

The Scanlan® Premier™ spring style scissors use a revolutionary, Scanlan proprietary technology that enhances the hardness and corrosion resistant properties of stainless steel. As a result, blades retain their sharpness longer and are very resistant to environmental damage.

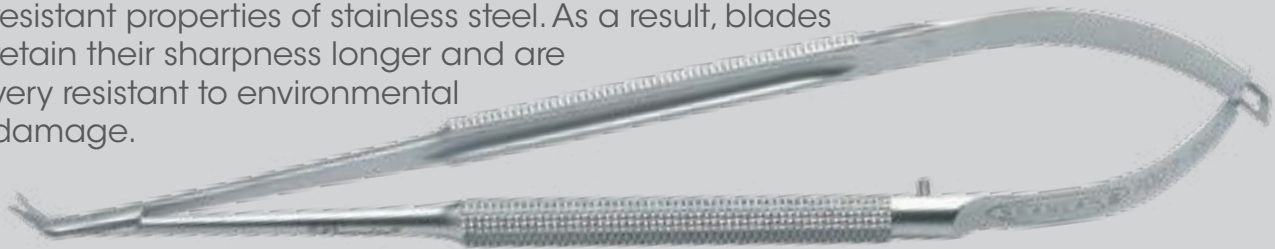

Round Handle
Page 5.2

25° Nano Blades	45° Nano Blades	60° Nano Blades	90° Nano Blades
7007-590-8	7007-592-8	7007-594-8	7007-596-8

Flat Handle
Page 5.12

25° Nano Blades	45° Nano Blades	60° Nano Blades	90° Nano Blades
7007-540-8	7007-542-8	7007-544-8	7007-546-8

NEW

Premier™

Super-Micro Fine Spring Style Scissors

The Scanlan® Premier™ Super-Micro Fine spring style scissors are ideal for microsurgery and pediatric surgeries.



Round Handle
Page 5.1

Flat Handle
Page 5.10

Curved Nano Blades		Curved Nano Blades	
7007-729	7-1/4" (18.5 cm)	7007-712	5" (12.7 cm)

NEW



M.D.® Retractor System

The SCANLAN® M.D.® Retractor System featuring the new Scan-Vu® single-use radiolucent arms... Perfect for procedures performed in the hybrid operating rooms.



The SCANLAN® M.D.® Retractor System with the reusable M.D.® titanium retractor arms, are designed for light-weight, reliable retraction for open surgical procedures.



SCANLAN®
M.D.® Retractor System
Page 6.20



Gening J SPH Snake™ Dissector

The SCANLAN® Gening J SPH Snake™ Dissector has triangular shaped tips for precise control during dissection and the size and shape of the tip are optimized for lymph node grasping.



SCANLAN®
Gening J SPH Snake™ Dissector
Page 7.15

With Ratchet		Without Ratchet	
9009-284	13 1/2" (34 cm)	9009-285	13 1/2" (34 cm)
9009-286	16 3/4 (42.4 cm)	9009-287	16 3/4 (42.4 cm)



Thoroscopic Grasping Dissector

NEW

The ratchets on this instrument are tuned to engage after the jaws meet making it function like a non-ratcheted dissector. The oval rings provide a secure grasp of lymph nodes during dissection.

The curved jaw improves visualization during VATS procedures.

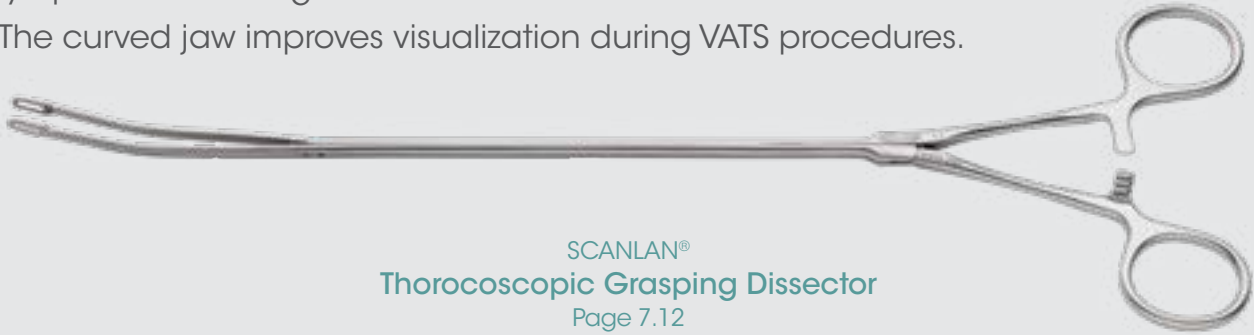

SCANLAN®
Thoroscopic Grasping Dissector
Page 7.12

With Ratchet

9009-290	13" (33 cm)
----------	-------------

Periosteal Elevator

NEW

Spatula like instrument for removing tissue from rib prior to resection.



SCANLAN®
Periosteal Elevator
Page 7.46

9009-823-14	14" (35.6 cm)
-------------	---------------

9009-823-17	17" (43.2 cm)
-------------	---------------

Foerster Grasping Clamp

NEW

The 25 x 35 oval ring jaws provide an atraumatic, secure grasp on delicate, friable tissue such as emphysematous tissue. The classic length works well for a variety of patient sizes and for most multi-port VATS procedures.

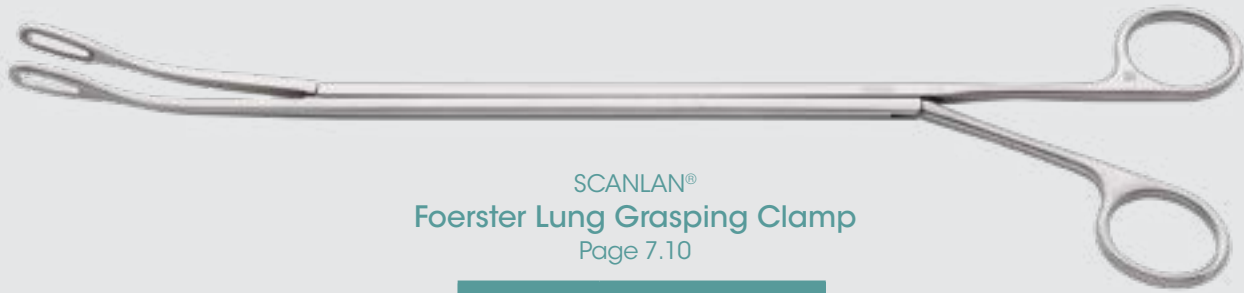

SCANLAN®
Foerster Lung Grasping Clamp
Page 7.10

Without Ratchet

9909-920-1	13-1/4" (33.5 cm)
------------	-------------------



NEW

Scanturian® Minimally Invasive Surgical Instruments

The SCANLAN® Scanturian® MIS Instruments are individually handcrafted assuring superior quality, durability and performance you expect in your Scanlan instruments.

— FORCEPS —

DeBakey Jaws | Resano Jaws
Page 8.1



— NEEDLE HOLDERS —

Carbon Inlay Jaws
Page 8.2



— NEEDLE HOLDERS —

DIAMOND DUST™ Jaws
Page 8.3



— SCISSORS —

Straight | Curved | Angled
Page 8.4



TITANIUM MICRO VASCULAR CLAMPS

Micro Clamps	2.1
Castaneda Clamps.....	2.5
Profunda.....	2.6
Lambert-Kay	2.7

TITANIUM MEDIUM VASCULAR CLAMPS

Castaneda Clamps.....	2.8
Peripheral Clamp.....	2.9
Beck Infant Aorta Clamp.....	2.10
Subramanian Infant Aorta Clamp.....	2.10
Dennis Multi-Purpose Clamps	2.11
Aorta Clamps.....	2.12
DeBakey Vascular Clamps	2.13

TITANIUM LARGE VASCULAR CLAMPS

DeBakey Vascular Clamps	2.14
Satinsky Clamps.....	2.15
Aorta Clamps.....	2.16

TITANIUM SPECIALTY

SCANLAN® Loftus™ Titanium Bulldog Shunt Clamps.....	2.17
---	------

MICRO VASCULAR

SCANLAN® Baby Vascular.....	2.18
-----------------------------	------

HAEMOSTATS

Ochsner Forceps / Phlebectomy Haemostat	2.44
Bailey Forceps	2.45
Hartman Mosquito Forceps	2.45
Vascular Mosquito Forceps.....	2.46
Vascular Forceps	2.48
Adson Forceps	2.49
Bengolea Forceps.....	2.50
Crafoord Artery Forceps	2.51
DeBakey Cooley Forceps	2.52

SPECIALTY

MacDougall Clamp	2.54
Prostatectomy Clamp.....	2.55
Allis Intestinal Clamp	2.55
Vasectomy Forceps	2.56

MEDIUM VASCULAR

SCANLAN® Vascular Clamps	2.23
Hausmann Clamps	2.24
Dennis Clamps	2.25
SCANLAN® Multi-Purpose.....	2.34
Dennis Aortic Anastomosis Clamps.....	2.35
Lambert / Kay Anastomosis Clamps.....	2.35
Dennis Multi-Purpose	2.36

LARGE VASCULAR

SCANLAN® Anastomosis	2.37
Tangential Occlusion Clamps	2.38
Satinsky Occlusion Clamps.....	2.39
Hunter-Satinsky Aortic Clamps	2.40
SCANLAN® Aortic Aneurysm Clamps.....	2.41
Pollock Aortic Clamps	2.43



Clamp Modifications

Modification	Description
904	Angle jaws/tips
904A	Angle and cut down jaws/tips
905	Cut down jaws/tips
907	Angled shanks - down
907B	Angled shanks - up
911	Cut down shanks
917	Bailey modification (30°, 60°, 90°)
923	Satin finish instrument
924	Tension modification
928	Modify to left-handed instrument (ring style)
928A	Modify to left-handed instrument (spring style)
929	Special etching
971	Lengthen instrument
973	Shorten instrument



3003-73 with modifications **904** and **907**

3003-73



9909-912-13 with modifications **907B**

9909-912-13

5005-51



5005-51 with modifications **917** (90°)

Please Note...

Each Scanlan instrument is individually handcrafted to provide the surgeon with the highest quality, longest-lasting, precision instrument possible. Reflecting this unique process, all stated dimensions are approximate.



3003-620
Instrument is shown approximate size



SCANLAN®
Micro Clamps
DeBakey Jaws

Instrument jaws are shown
approximate size

	Cat. No.	Description	Total Length
	3003-616	6 mm Jaws Slightly Angled Shanks 14 mm Jaw Length	4 1/8" (10.5 cm)
	3003-618	6 mm Spoon Jaws Straight Shanks 14 mm Jaw Length	
	3003-620	9 mm Jaws Slightly Angled Shanks 16 mm Jaw Length	
	3003-636	6 mm Jaws Slightly Angled Shanks 22 mm Jaw Length	4 3/8" (11.2 cm)
	3003-637	9 mm Jaws Slightly Angled Shanks 20 mm Jaw Length	
	3003-638	6 mm Spoon Jaws Straight Shanks 26 mm Jaw Length	4 5/8" (11.8 cm)

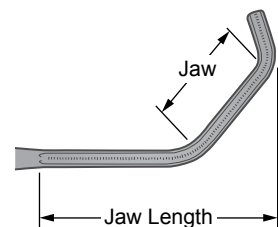

Please Note...
Each Scanlan instrument is individually handcrafted to provide the surgeon with the highest quality, longest-lasting, precision instrument possible.
Reflecting this unique process, all stated dimensions are approximate.

Please check with your Scanlan Representative for Firm Sale status. Custom modifications available upon request.
For a complete listing of models visit... www.scanlaninternational.com





SCANLAN®
Micro Clamps
Angled DeBakey Jaws

Instrument jaws are shown approximate size

	Cat. No.	Description	Total Length
	3003-613	45° Angled Jaws 25 mm Jaw Length	4 1/4" (11 cm)
	3003-633	45° Angled Jaws 30 mm Jaw Length	4 1/2" (11.5 cm)
	3003-614	60° Angled Jaws 23 mm Jaw Length	4 1/8" (10.5 cm)
	3003-634	60° Angled Jaws 30 mm Jaw Length	4 1/4" (11 cm)

Please Note...

Each Scanlan instrument is individually handcrafted to provide the surgeon with the highest quality, longest-lasting, precision instrument possible. Reflecting this unique process, all stated dimensions are approximate.

3003-610

Instrument is shown approximate size

Titanium CLAMPS

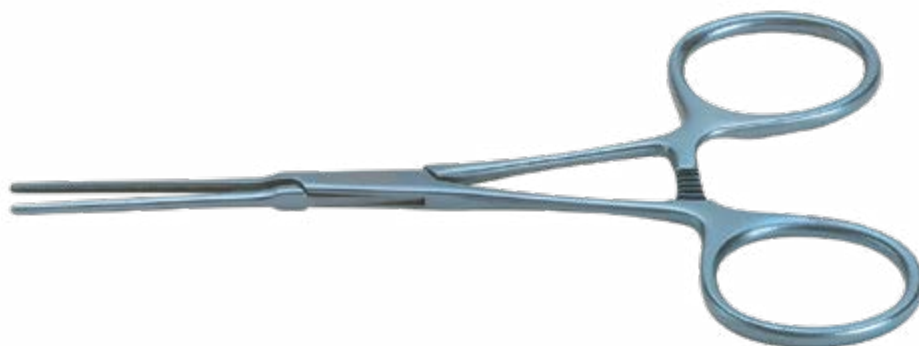

SCANLAN®
Micro Clamps
 Angled DeBakey Jaws

Instrument jaws are shown approximate size

		Cat. No.	Description	Total Length
		3003-610	Straight Shanks 30 mm Jaw Length	4 3/4" (12 cm)
		3003-611	Slightly Angled Shanks 30 mm Jaw Length	
		3003-612	Angled Shanks 22 mm Jaw Length	4 1/4" (11 cm)
		3003-632	Angled Shanks 30 mm Jaw Length	4 5/8" (11.8 cm)

Please check with your Scanlan Representative for Firm Sale status. Custom modifications available upon request.
 For a complete listing of models visit... www.scanlaninternational.com







SCANLAN®

Micro Kitzmiller Clamps

Angled DeBakey Jaws

	Cat. No.	Description	Total Length
	3003-628	Left Angled Jaws 23 mm Jaw Length	4 1/4" (11 cm)
	3003-630	Right Angled Jaws 23 mm Jaw Length	

Please Note...

Each Scanlan instrument is individually handcrafted to provide the surgeon with the highest quality, longest-lasting, precision instrument possible. Reflecting this unique process, all stated dimensions are approximate.

3003-52

Instrument is shown approximate size

Titanium CLAMPS



SCANLAN®
Castaneda Clamps
Cooley Jaws

Instrument jaws are shown approximate size

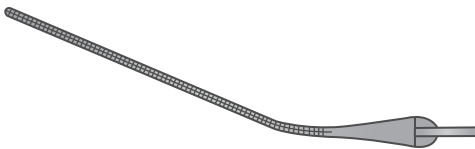
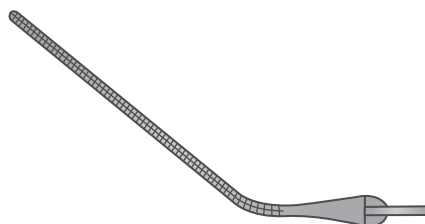
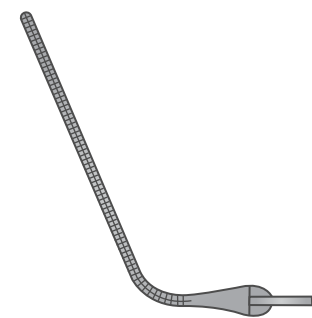
	Cat. No.	Description	Total Length
	3003-52	30° Angled Jaws	5 1/4" (13.5 cm)
	3003-54	50° Angled Jaws	
	3003-56	70° Angled Jaws	4 3/4" (12 cm)

Please check with your Scanlan Representative for Firm Sale status. Custom modifications available upon request.

For a complete listing of models visit... www.scanlaninternational.com



3003-617

Instrument is shown approximate size



SCANLAN®
Micro Clamps

Instrument jaws are shown approximate size

	Cat. No.	Description	Total Length
	<p>NEW 3003-617</p>	<p>Profunda Clamp Angled Shanks DeBakey Jaws</p>	<p>5 1/8" (13 cm)</p>

Please Note...

Each Scanlan instrument is individually handcrafted to provide the surgeon with the highest quality, longest-lasting, precision instrument possible. Reflecting this unique process, all stated dimensions are approximate.

3003-59

Instrument is shown approximate size

Titanium CLAMPS



SCANLAN®
Micro Clamp

Instrument jaws are shown approximate size

	Cat. No.	Description	Total Length
	<p>NEW 3003-59</p>	<p>Lambert-Kay Angled Shanks Cooley Jaws</p>	<p>4 1/4" (11 cm)</p>

Please check with your Scanlan Representative for Firm Sale status. Custom modifications available upon request.
For a complete listing of models visit... www.scanlaninternational.com



Titanium CLAMPS

3003-46

Instrument is shown approximate size

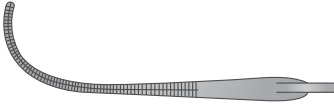
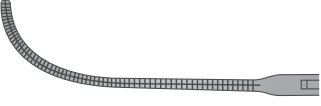

SCANLAN®
Castaneda Clamps
Cooley Jaws

Instrument jaws are shown approximate size	Cat. No.	Description	Total Length
	3003-47	Curved Jaws	6" (15 cm)
	3003-46	Slightly Curved Jaws	

3003-67



SCANLAN®
Castaneda Clamps
Double-Angled Cooley Jaws

Instrument jaws are shown approximate size	Cat. No.	Description	Total Length
	3003-67	Carotid Clamp	7 1/2" (19 cm)

Please Note...

Each Scanlan instrument is individually handcrafted to provide the surgeon with the highest quality, longest-lasting, precision instrument possible. Reflecting this unique process, all stated dimensions are approximate.

3003-64

Instrument is shown approximate size

Titanium CLAMPS



SCANLAN®
Peripheral Clamp
DeBakey Jaws

Instrument jaws are shown approximate size

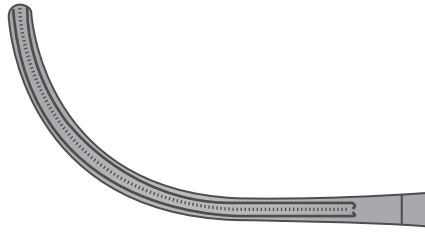
	Cat. No.	Description	Total Length
	3003-64	Peripheral Clamp Curved DeBakey Jaws	6 1/4" (16 cm)

Please check with your Scanlan Representative for Firm Sale status. Custom modifications available upon request.
For a complete listing of models visit... www.scanlaninternational.com



Titanium CLAMPS

3003-66

Instrument is shown approximate size



SCANLAN®
Beck Infant Aorta Clamp
DeBakey Jaws

Instrument jaws are shown approximate size

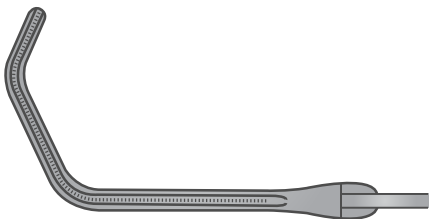
	Cat. No.	Description	Total Length
	3003-66	Beck Infant Aorta Clamp DeBakey Jaws	6 1/2" (16.5 cm)

3003-68

Instrument is shown approximate size

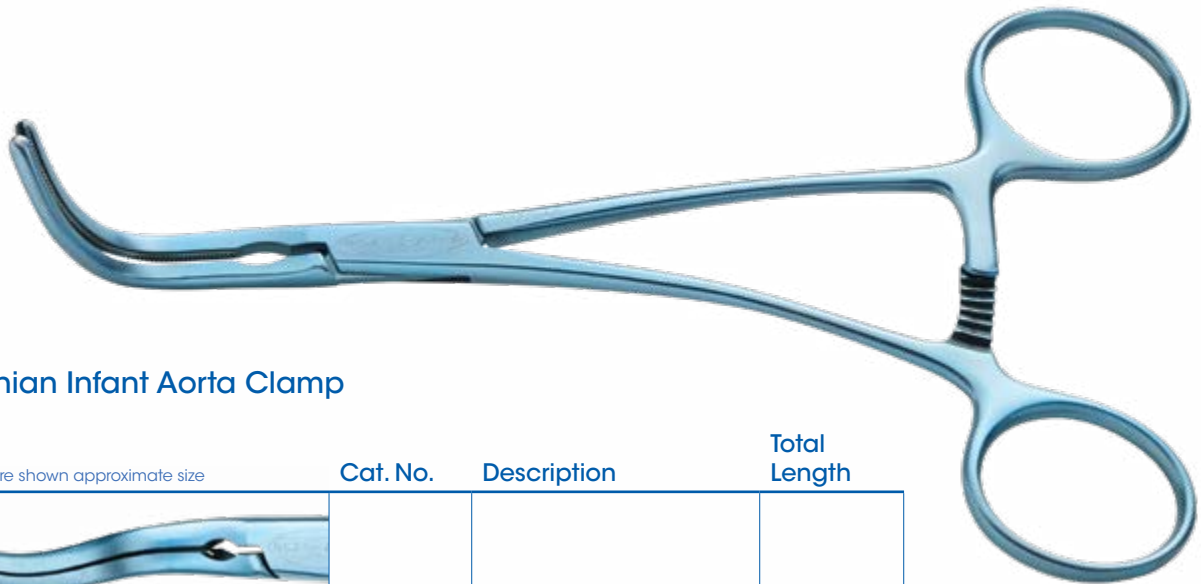

SCANLAN®
Subramanian Infant Aorta Clamp
DeBakey Jaws

Instrument jaws are shown approximate size

	Cat. No.	Description	Total Length
 <p>Top View</p>	3003-68	Subramanian Infant Aorta Clamp DeBakey Jaws	6 1/4" (16 cm)

Please Note...

Each Scanlan instrument is individually handcrafted to provide the surgeon with the highest quality, longest-lasting, precision instrument possible. Reflecting this unique process, all stated dimensions are approximate.



Medium Vascular | Dennis Multi-Purpose

3003-282

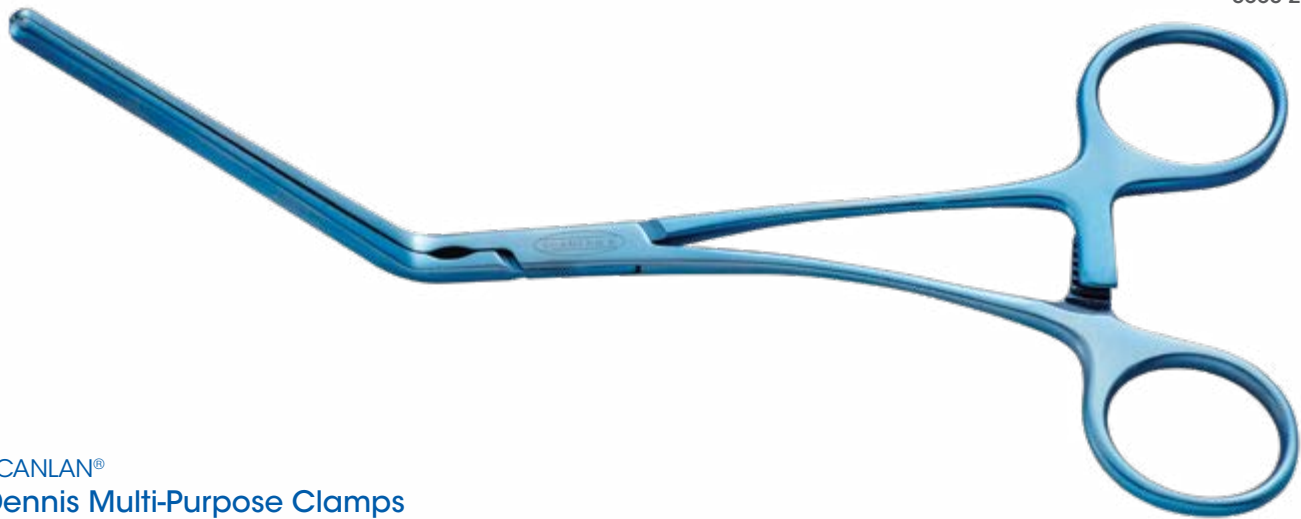
Titanium CLAMPS



SCANLAN®
Dennis Multi-Purpose Clamps
DeBakey Jaws

	Cat. No.	Description	Total Length
	3003-280	Straight 2 x 3 DeBakey Jaws 8.5 cm Jaw Length	8 1/2" (21.5 cm)
	3003-282	45° Angled 2 x 3 DeBakey Jaws 8 cm Jaw Length	8" (20 cm)
	3003-286	90° Angled 2 x 3 DeBakey Jaws 6 cm Jaw Length	5 1/2" (14 cm)

Please check with your Scanlan Representative for Firm Sale status. Custom modifications available upon request.
For a complete listing of models visit... www.scanlaninternational.com





SCANLAN®
Aorta Clamps
DeBakey Jaws

Instrument jaws are shown approximate size

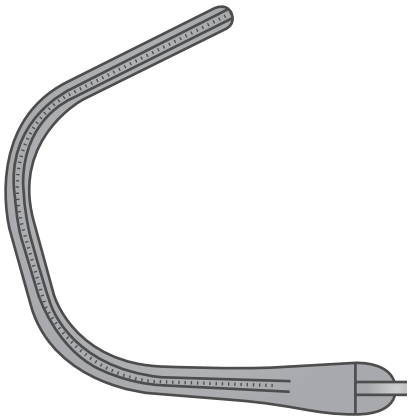
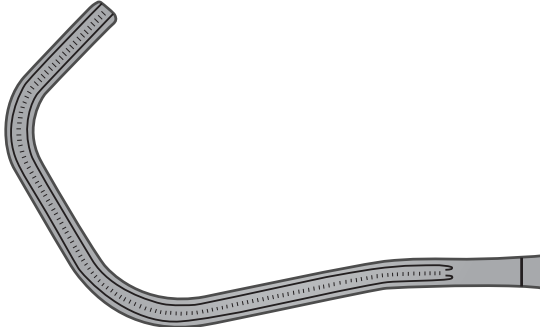
	Cat. No.	Description	Total Length
	3003-70	Kay Aorta Clamp 3 cm Jaws	8" (20 cm)
	3003-72	Lambert-Kay Aorta Clamp 3 cm Jaws	

Please Note...

Each Scanlan instrument is individually handcrafted to provide the surgeon with the highest quality, longest-lasting, precision instrument possible. Reflecting this unique process, all stated dimensions are approximate.

3003-69

Titanium CLAMPS



SCANLAN®
DeBakey Vascular Clamps
 DeBakey Jaws

Instrument jaws are shown approximate size

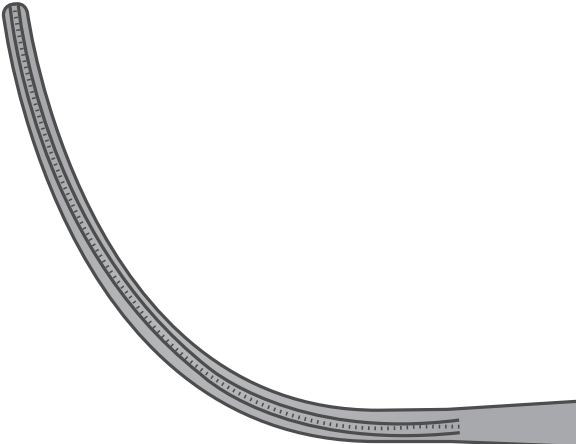
	Cat. No.	Description	Total Length
	3003-69	7.5 cm Jaws	7 3/8" (18.8 cm)

Please check with your Scanlan Representative for Firm Sale status. Custom modifications available upon request.
 For a complete listing of models visit... www.scanlaninternational.com



Titanium CLAMPS

3003-79



SCANLAN®

DeBakey Vascular Clamps

DeBakey Jaws

Instrument jaws are shown approximate size

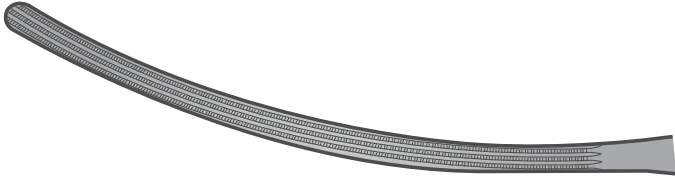
	Cat. No.	Description	Total Length
	3003-79	8 cm Jaws 2x3 DeBakey Wide Jaw	11" (28 cm)

Please Note...

Each Scanlan instrument is individually handcrafted to provide the surgeon with the highest quality, longest-lasting, precision instrument possible. Reflecting this unique process, all stated dimensions are approximate.

3003-86

Titanium CLAMPS

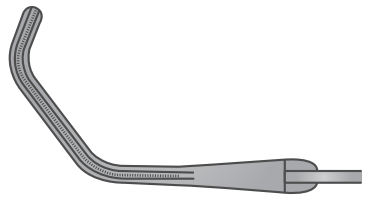
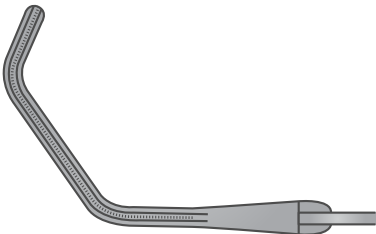
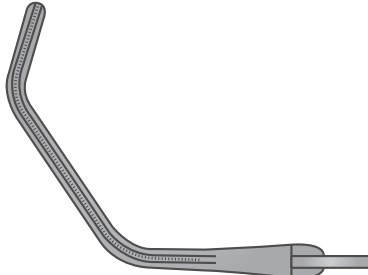
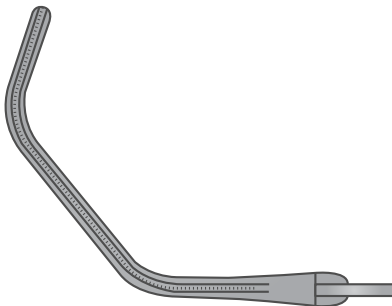

SCANLAN®
Satinsky Clamps
 DeBaKey Jaws

	Cat. No.	Description	Total Length
	3003-84	2 cm Jaws	10" (25.4 cm)
	3003-82	2.5 cm Jaws	
	3003-80	3 cm Jaws	
	3003-86	3.5 cm Jaws	

Please check with your Scanlan Representative for Firm Sale status. Custom modifications available upon request.
 For a complete listing of models visit... www.scanlaninternational.com





Titanium CLAMPS

3003-88

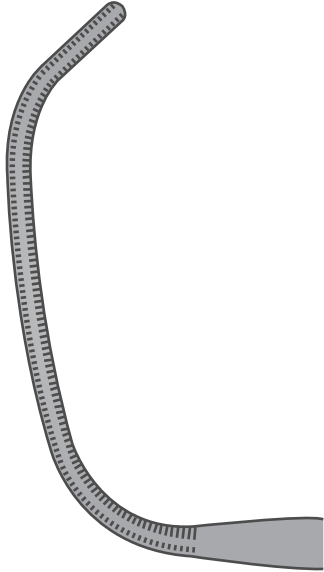

SCANLAN®
Aorta Clamps

	Cat. No.	Description	Total Length
	3003-74	5.5 cm Curved Cooley Jaws	9 3/4" (24.8 cm)
	3003-88	7 cm 2x3 DeBakey Jaws	10 1/2" (27 cm)

Please Note...

Each Scanlan instrument is individually handcrafted to provide the surgeon with the highest quality, longest-lasting, precision instrument possible. Reflecting this unique process, all stated dimensions are approximate.

4385-42



Titanium CLAMPS

SCANLAN®
Loftus™ Titanium Bulldog Shunt Clamps

	Cat. No.	Description	Total Length
	4385-40	10° Angled 10 Fr.	3 3/4" (9.5 cm)
	4385-42	25° Angled 10 Fr.	
	4385-44	45° Angled 10 Fr.	
	4385-46	60° Angled 10 Fr.	
	4384-40	10° Angled 12 Fr.	
	4384-42	25° Angled 12 Fr.	
	4384-44	45° Angled 12 Fr.	
	4384-46	60° Angled 12 Fr.	
	4383-40	10° Angled 14 Fr.	
	4383-42	25° Angled 14 Fr.	
	4383-44	45° Angled 14 Fr.	
	4383-46	60° Angled 14 Fr.	

Please check with your Scanlan Representative for Firm Sale status. Custom modifications available upon request.

For a complete listing of models visit... www.scanlaninternational.com



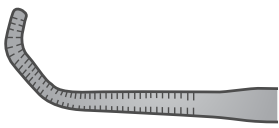
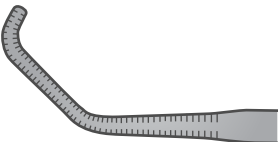
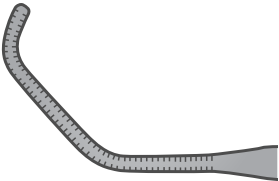
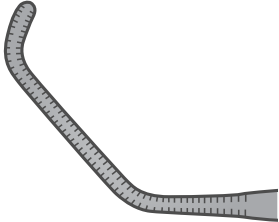

SCANLAN®
Baby Vascular Clamps
 Cooley Jaws

	Cat. No.	Description	Total Length
	2002-246	8 mm Jaws	5 3/4" (14.5 cm)
	2002-244	12 mm Jaws	
	2002-242	16 mm Jaws	5 1/4" (13.5 cm)
	2002-240	20 mm Jaws	

Please Note...

Each Scanlan instrument is individually handcrafted to provide the surgeon with the highest quality, longest-lasting, precision instrument possible. Reflecting this unique process, all stated dimensions are approximate.

2002-234

Instrument is shown approximate size



Stainless Steel CLAMPS

SCANLAN®
Baby Vascular Clamps
 Cooley Jaws

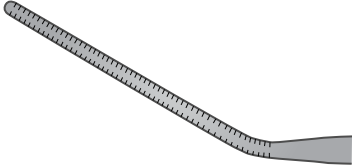
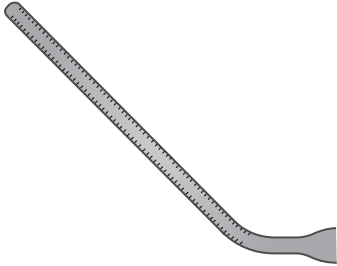
Instrument jaws are shown approximate size	Cat. No.	Description	Total Length
	2002-232	4 cm Straight Jaws	6" (15 cm)
	2002-234	25° Angled Jaws	5 3/4" (14.5 cm)
	2002-235	45° Angled Jaws	

Please check with your Scanlan Representative for Firm Sale status. Custom modifications available upon request.
 For a complete listing of models visit... www.scanlaninternational.com



2002-236

Instrument is shown approximate size



SCANLAN®

Baby Vascular Clamps

Cooley Jaws

Instrument jaws are shown approximate size

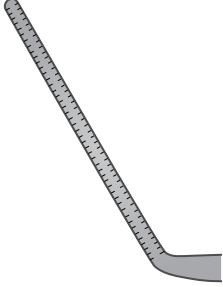
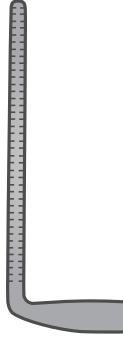
	Cat. No.	Description	Total Length
	2002-236	60° Angled Jaws	5 1/4" (13.5 cm)
	2002-238	90° Angled Jaws	

Please Note...

Each Scanlan instrument is individually handcrafted to provide the surgeon with the highest quality, longest-lasting, precision instrument possible. Reflecting this unique process, all stated dimensions are approximate.

2002-231



Instrument is shown approximate size



Stainless Steel CLAMPS

SCANLAN®
Baby Vascular Clamps
 Cooley Jaws

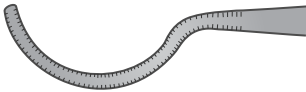
Instrument jaws are shown approximate size

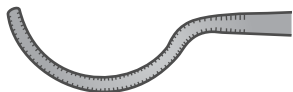
	Cat. No.	Description	Total Length
	2002-229	Small Spoon Jaws Straight Shanks	5 3/4" (14.5 cm)
	2002-230	Spoon Jaws Straight Shanks	6" (15 cm)
	2002-231	Profunda Clamp Angled Shanks	5 1/2" (14 cm)

Please check with your Scanlan Representative for Firm Sale status. Custom modifications available upon request.
 For a complete listing of models visit... www.scanlaninternational.com



2002-248

Instrument is shown approximate size



SCANLAN®
Baby Vascular Clamps
 Cooley Jaws

	Cat. No.	Description	Total Length
	2002-248	Kitzmiller, Left Angled Jaws	5 1/4" (13.5 cm)
	2002-250	Kitzmiller, Right Angled Jaws	

Please Note...

Each Scanlan instrument is individually handcrafted to provide the surgeon with the highest quality, longest-lasting, precision instrument possible. Reflecting this unique process, all stated dimensions are approximate.

2002-128



Stainless Steel CLAMPS

SCANLAN®
Vascular Clamps
 DeBakey Jaws

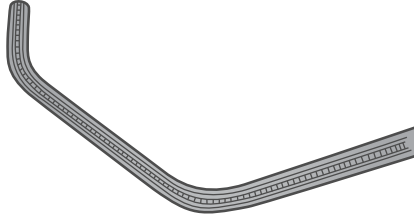
	Cat. No.	Description	Total Length
	2002-128	6.5 cm Straight Jaws Straight Shanks	8 1/2" (21.5 cm)
	2002-134	30 mm Jaws Angled Shanks	8" (20 cm)

Please check with your Scanlan Representative for Firm Sale status. Custom modifications available upon request.
 For a complete listing of models visit... www.scanlaninternational.com



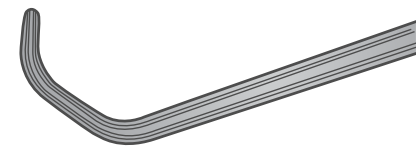
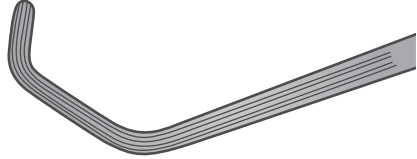

SCANLAN®
Vascular Clamps
 Hausmann Jaws

	Cat. No.	Description	Total Length
	2002-186	12 mm Jaws Straight Shanks	8" (20 cm)
	2002-184	18 mm Jaws Straight Shanks	

Please Note...

Each Scanlan instrument is individually handcrafted to provide the surgeon with the highest quality, longest-lasting, precision instrument possible. Reflecting this unique process, all stated dimensions are approximate.

Medium Vascular | Dennis Carotid

2002-90



Stainless Steel CLAMPS

SCANLAN®
Dennis Carotid Clamps
 DeBakey Jaws

	Cat. No.	Description	Total Length
	2002-90	1.5 cm Carotid Clamp	7" (18 cm)

Medium Vascular | Dennis Peripheral

2002-78

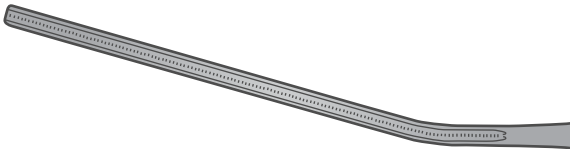

SCANLAN®
Dennis Peripheral Vascular Clamps
 DeBakey Jaws

	Cat. No.	Description	Total Length
	2002-78	6 cm DeBakey Jaws	8" (20 cm)

Please check with your Scanlan Representative for Firm Sale status. Custom modifications available upon request.
 For a complete listing of models visit... www.scanlaninternational.com





SCANLAN®

Dennis Anastomosis Clamps

Cooley Jaws

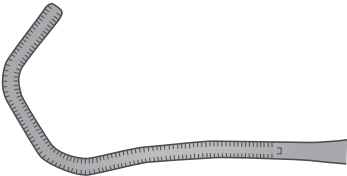
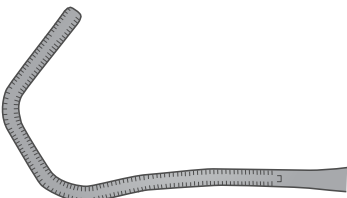
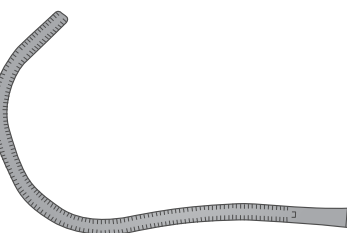
	Cat. No.	Description	Total Length
	2002-92	1 cm Jaws	6 1/2" (16.5 cm)
	2002-94	1.5 cm Jaws	6 3/4" (17 cm)
	2002-96	2 cm Jaws	

Please Note...

Each Scanlan instrument is individually handcrafted to provide the surgeon with the highest quality, longest-lasting, precision instrument possible. Reflecting this unique process, all stated dimensions are approximate.

Medium Vascular | Dennis Anastomosis

2002-62

Instrument is shown approximate size

Stainless Steel CLAMPS

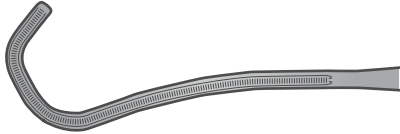
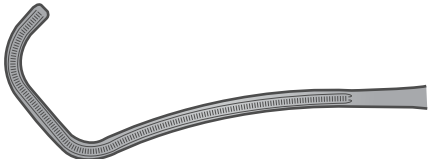
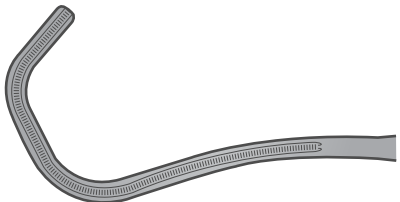

SCANLAN®
Dennis Anastomosis Clamps
 DeBaKey Jaws

	Cat. No.	Description	Total Length
	2002-62	1 cm Jaws	7" (18 cm)
	2002-64	1.5 cm Jaws	
	2002-70	1.5 cm Jaws	

Please check with your Scanlan Representative for Firm Sale status. Custom modifications available upon request.
 For a complete listing of models visit... www.scanlaninternational.com



Stainless Steel CLAMPS

2002-72

Instrument is shown approximate size



SCANLAN®

Dennis Anastomosis Clamps

DeBaKey Jaws

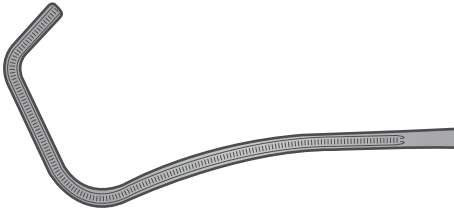
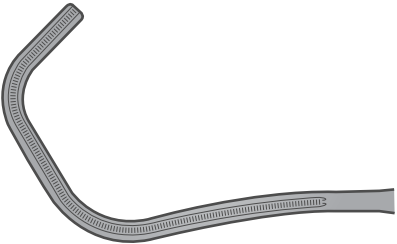
	Cat. No.	Description	Total Length
	2002-66	2 cm Jaws	7" (18 cm)
	2002-72	2 cm Jaws	

Please Note...

Each Scanlan instrument is individually handcrafted to provide the surgeon with the highest quality, longest-lasting, precision instrument possible. Reflecting this unique process, all stated dimensions are approximate.

Medium Vascular | Dennis Anastomosis

2002-100
Instrument is shown approximate size

Stainless Steel CLAMPS

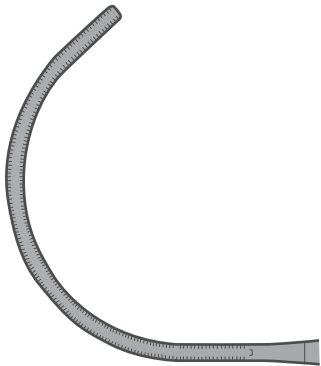
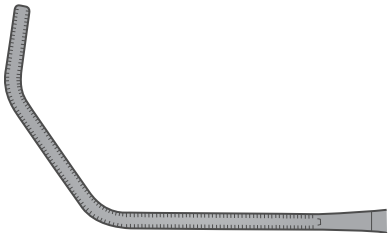

SCANLAN®
Dennis Anastomosis Clamps
Cooley Jaws

	Cat. No.	Description	Total Length
	2002-100	Semi-Circle Jaws	6 3/4" (17 cm)
	2002-106	2 cm Jaws	7" (18 cm)

Please check with your Scanlan Representative for Firm Sale status. Custom modifications available upon request.
For a complete listing of models visit... www.scanlaninternational.com



2002-110

Instrument is shown approximate size



SCANLAN®

Dennis Multi-Purpose Clamps

Cooley Jaws

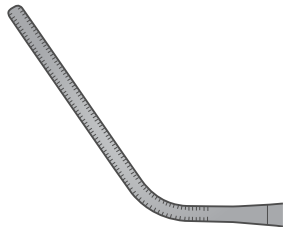
	Cat. No.	Description	Total Length
	2002-110	3 cm Angled Jaws	6 1/4" (16 cm)

Please Note...

Each Scanlan instrument is individually handcrafted to provide the surgeon with the highest quality, longest-lasting, precision instrument possible. Reflecting this unique process, all stated dimensions are approximate.

Medium Vascular | Dennis Multi-Purpose

2002-286

Instrument is shown approximate size



Stainless Steel CLAMPS

SCANLAN®
Dennis Multi-Purpose Clamps
 DeBakey Jaws

	Cat. No.	Description	Total Length
	2002-280	Straight 2 x 3 DeBakey Jaws 8.5 cm Jaw Length	8 1/2" (21.5 cm)
	2002-282	45° Angled 2 x 3 DeBakey Jaws 8 cm Jaw Length	8" (20 cm)
	2002-286	90° Angled 2 x 3 DeBakey Jaws 6 cm Jaw Length	5 1/2" (14 cm)

Please check with your Scanlan Representative for Firm Sale status. Custom modifications available upon request.
 For a complete listing of models visit... www.scanlaninternational.com



2002-82

Instrument is shown approximate size

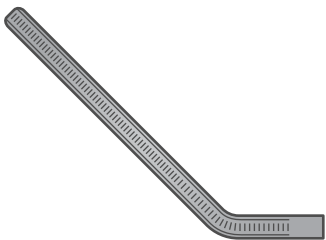
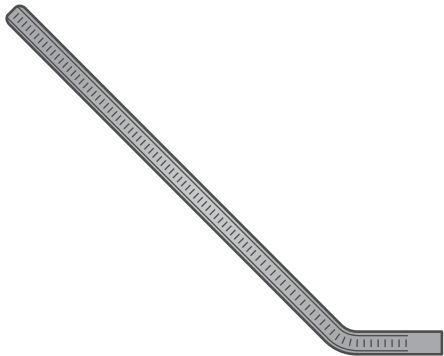

SCANLAN®
Dennis Multi-Purpose Clamps
 Angled DeBakey Jaws

	Cat. No.	Description	Total Length
	2002-82	4 cm 45° Angled Jaws	6 1/4" (16 cm)
	2002-80	6 cm 45° Angled Jaws	7 1/4" (18.5 cm)

Please Note...

Each Scanlan instrument is individually handcrafted to provide the surgeon with the highest quality, longest-lasting, precision instrument possible. Reflecting this unique process, all stated dimensions are approximate.

Medium Vascular | Dennis Multi-Purpose

2002-88

Stainless Steel CLAMPS

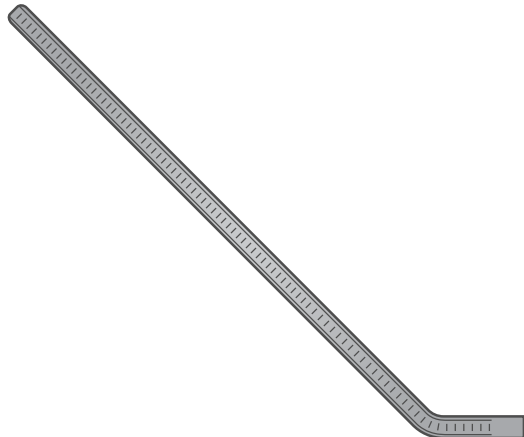
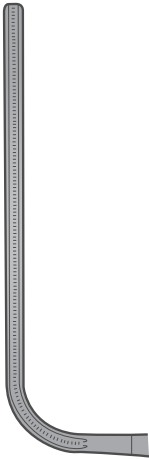

SCANLAN®
Dennis Multi-Purpose Clamps
 Angled DeBakey Jaws

	Cat. No.	Description	Total Length
	2002-88	8 cm 45° Angled Jaws	8" (20 cm)
	2002-86	6 cm 90° Angled Jaws	5 1/2" (14 cm)

Please check with your Scanlan Representative for Firm Sale status. Custom modifications available upon request.
 For a complete listing of models visit... www.scanlaninternational.com



Stainless Steel CLAMPS



SCANLAN®
Multi-Purpose Clamps
Angled DeBakey Jaws

Instrument jaws are shown approximate size

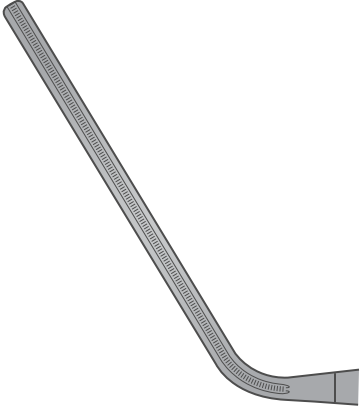
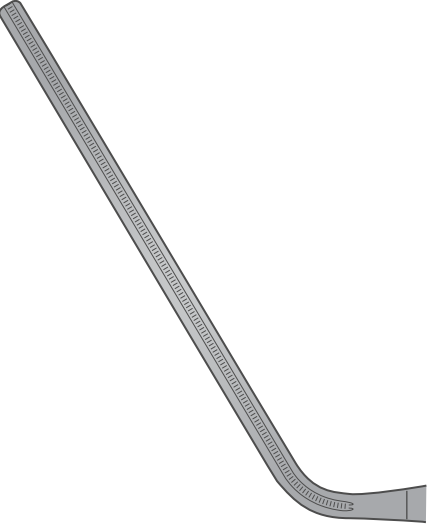
	Cat. No.	Description	Total Length
	2002-14	6 cm 60° Angled Jaws	
	2002-16	7.5 cm 60° Angled Jaws	9" (23 cm)

Please Note...

Each Scanlan instrument is individually handcrafted to provide the surgeon with the highest quality, longest-lasting, precision instrument possible. Reflecting this unique process, all stated dimensions are approximate.

2002-76

Stainless Steel CLAMPS



SCANLAN®

Dennis Aortic Anastomosis Clamps

DeBakey Jaws

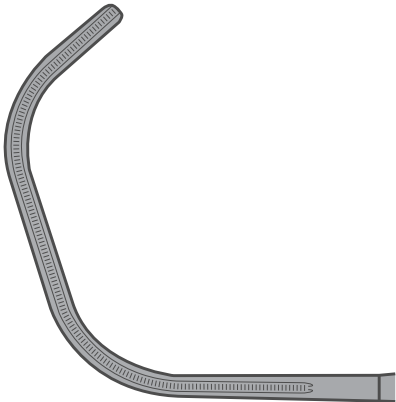
	Cat. No.	Description	Total Length
	2002-76	Aorta Clamp 3 cm Jaws	7" (18 cm)

SCANLAN®

Lambert-Kay Anastomosis Clamps

DeBakey Jaws

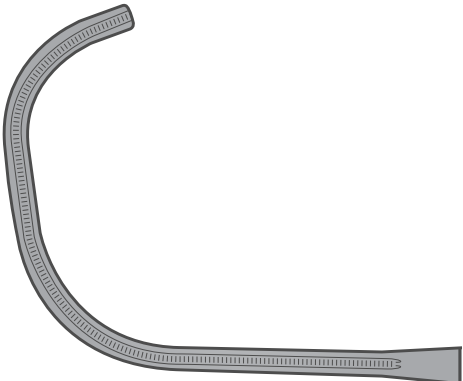
	Cat. No.	Description	Total Length
	2002-42	Aorta Clamp 3 cm Jaws	8 3/4" (22 cm)

Please check with your Scanlan Representative for Firm Sale status. Custom modifications available upon request.
For a complete listing of models visit... www.scanlaninternational.com





SCANLAN®
Dennis Multi-Purpose Clamps
Straight Jaws

Cat. No.	Description	Total Length
2002-112	4 cm Cooley Jaws, Angled Shanks	6 3/4" (17 cm)
2002-23	8 cm DeBakey Jaws	10 1/4" (26 cm)
2002-113	8.5 cm Cooley Jaws, Angled Shanks	8 1/2" (21.5 cm)
2002-13	8.5 cm DeBakey Jaws	8 1/2" (21.5 cm)
2002-43	10.5 cm DeBakey Jaws	11 3/8" (28.8 cm)
2002-51	11 cm DeBakey Jaws	12 1/2" (32 cm)
2002-33	13.5 cm DeBakey Jaws	13" (33 cm)

Please Note...

Each Scanlan instrument is individually handcrafted to provide the surgeon with the highest quality, longest-lasting, precision instrument possible. Reflecting this unique process, all stated dimensions are approximate.

Large Vascular | SCANLAN® Anastomosis

2002-38



Stainless Steel CLAMPS

SCANLAN®
Anastomosis Clamps
 DeBaKey Jaws

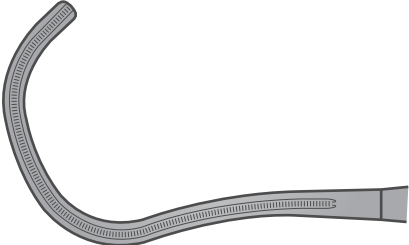
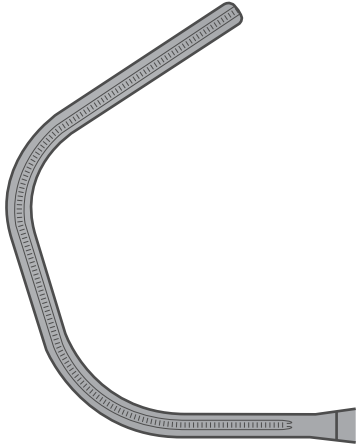
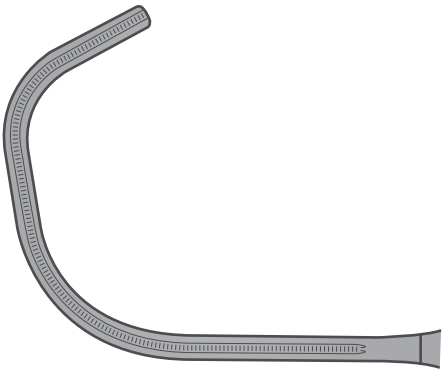
	Cat. No.	Description	Total Length
	2002-52	2 cm Jaws	
	2002-38	3.5 cm Jaws	8 1/2" (21.5 cm)
	2002-40		10 1/4" (26 cm)

Please check with your Scanlan Representative for Firm Sale status. Custom modifications available upon request.
 For a complete listing of models visit... www.scanlaninternational.com



Stainless Steel CLAMPS



SCANLAN®
Tangential Occlusion Clamps
 DeBakey Jaws

Instrument jaws are shown approximate size

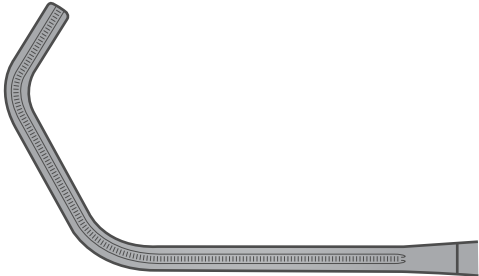
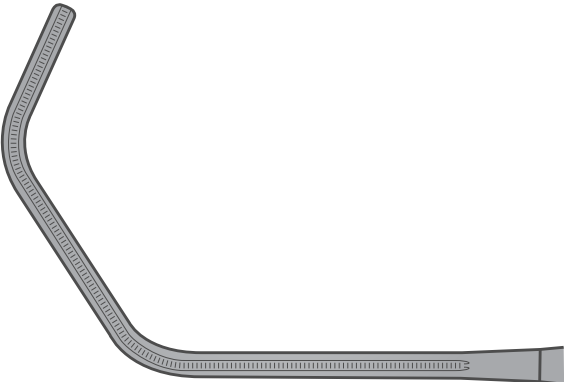
	Cat. No.	Description	Total Length
	2002-28	2.5 cm Jaws	9" (23 cm)
	2002-30	3.4 cm Jaws	9 1/4" (23.5 cm)

Please Note...

Each Scanlan instrument is individually handcrafted to provide the surgeon with the highest quality, longest-lasting, precision instrument possible. Reflecting this unique process, all stated dimensions are approximate.

Large Vascular | Satinsky Occlusion

2002-34



Stainless Steel CLAMPS

SCANLAN®
Satinsky Occlusion Clamps
 DeBakey Jaws

Instrument jaws are shown approximate size

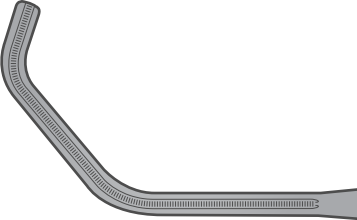
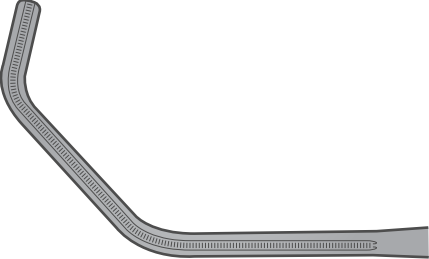
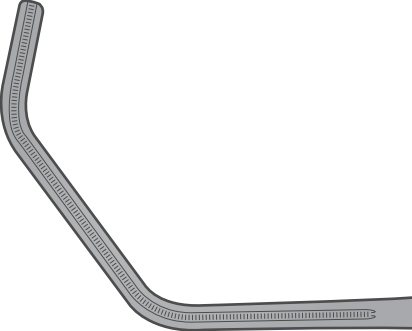
	Cat. No.	Description	Total Length
	2002-34	2.3 cm Jaws	8 1/2" (21.5 cm)
	2002-32	2.7 cm Jaws	
	2002-36	3.5 cm Jaws	

Please check with your Scanlan Representative for Firm Sale status. Custom modifications available upon request.
 For a complete listing of models visit... www.scanlaninternational.com



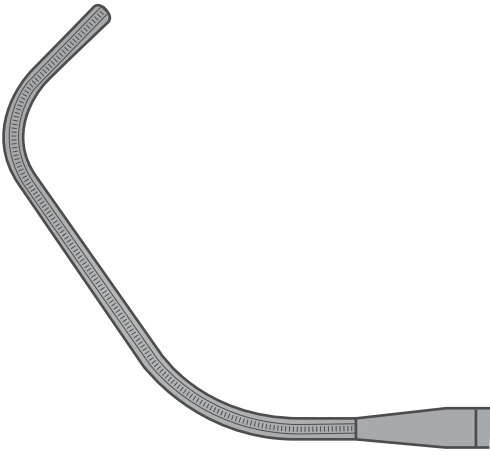
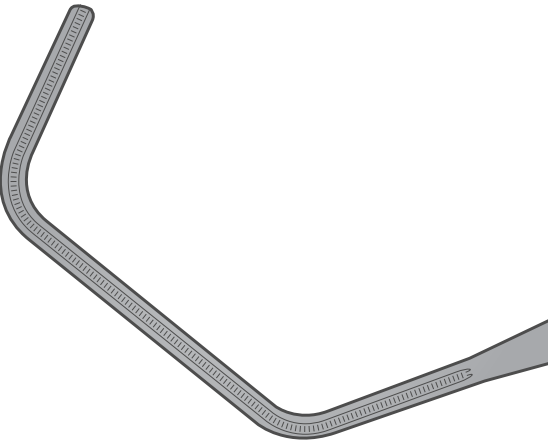

SCANLAN®
Hunter-Satinsky Aortic Clamps

	Cat. No.	Description	Total Length
	2002-116	4.0 cm jaws Blunted Potts Teeth Jaws	8 3/4" (22 cm)
	2002-117	3.5 cm Jaws DeBakey Jaws	

Please Note...

Each Scanlan instrument is individually handcrafted to provide the surgeon with the highest quality, longest-lasting, precision instrument possible. Reflecting this unique process, all stated dimensions are approximate.

2002-44

Stainless Steel CLAMPS



SCANLAN®
Aortic Aneurysm Clamps
DeBakey Jaws

Instrument jaws are shown approximate size

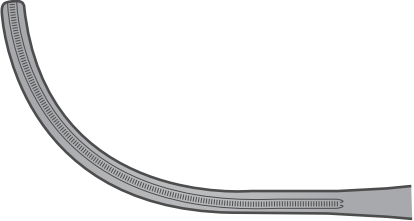
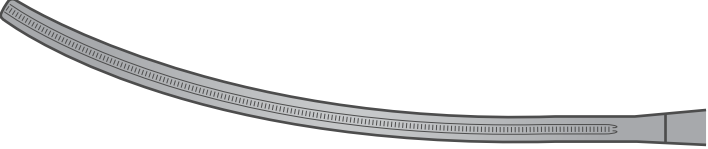
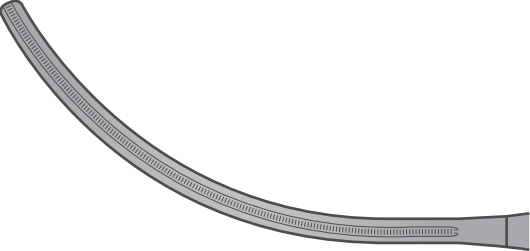
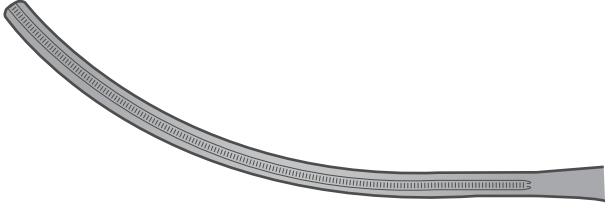
	Cat. No.	Description	Total Length
	2002-46	5 cm Jaws	8 1/2" (21.5 cm)
	2002-44	8 cm Curved Jaws Reversed Handle Curvature	10 1/4" (26 cm)
	2002-48	7 cm Jaws	10 3/4" (27.3 cm)
	2002-50	7.5 cm Jaws	11" (28 cm)

Please check with your Scanlan Representative for Firm Sale status. Custom modifications available upon request.
For a complete listing of models visit... www.scanlaninternational.com



Stainless Steel CLAMPS

2002-22



SCANLAN®
Aortic Aneurysm Clamps
DeBakey Jaws

	Cat. No.	Description	Total Length
	2002-22	5.0 cm Jaws	10 3/4" (27.3 cm)

Please Note...

Each Scanlan instrument is individually handcrafted to provide the surgeon with the highest quality, longest-lasting, precision instrument possible. Reflecting this unique process, all stated dimensions are approximate.

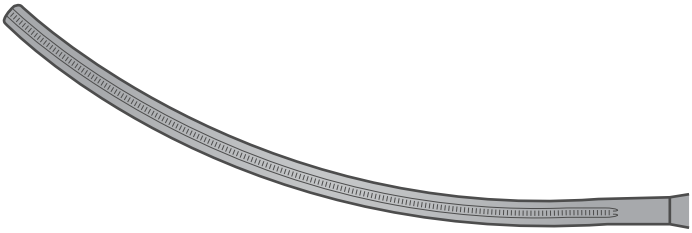

SCANLAN®
Pollock Aortic Clamps
 DeBakey Jaws

	Cat. No.	Description	Total Length
	2002-54	8.0 cm Jaws	10" (25.4 cm)

Please check with your Scanlan Representative for Firm Sale status. Custom modifications available upon request.
 For a complete listing of models visit... www.scanlaninternational.com



5005-80

Instrument is shown approximate size

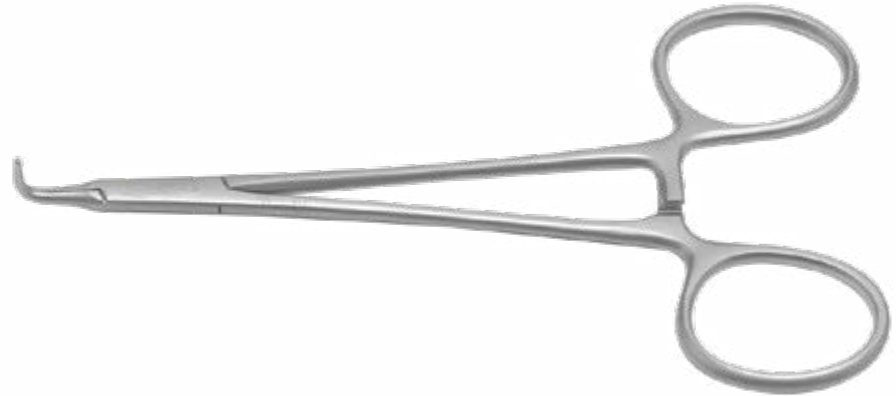

SCANLAN®
Phlebectomy Haemostat

Instrument jaws are shown approximate size

	Cat. No.	Description	Total Length
	5005-80	90° Angled Very Fine Jaws Sharp Grasping Serrations	4 1/2" (11.5 cm)

9009-148

Instrument is shown approximate size

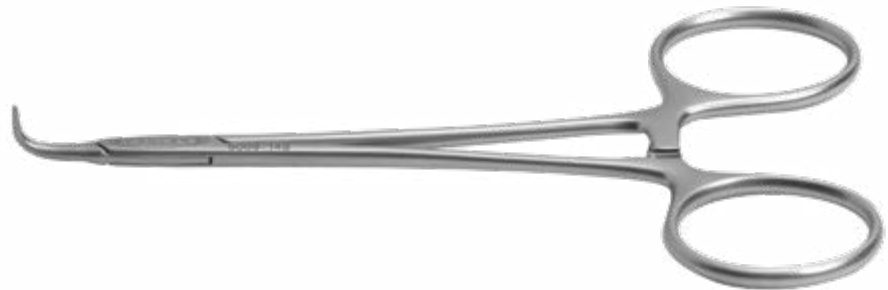

SCANLAN®
Ochsner Forceps

Instrument jaws are shown approximate size

	Cat. No.	Description	Total Length
	9009-148	90° Angled Very Fine Serrated Jaws	4 1/2" (11.5 cm)

Please Note...

Each Scanlan instrument is individually handcrafted to provide the surgeon with the highest quality, longest-lasting, precision instrument possible. Reflecting this unique process, all stated dimensions are approximate.

5005-64



Instrument is shown approximate size

Stainless Steel CLAMPS



SCANLAN®
Bailey Forceps

Instrument jaws are shown approximate size

	Cat. No.	Description	Total Length
	5005-60	30° Angled Jaws Very Fine Angled Serrated Jaws	7" (18 cm)
	5005-62	60° Angled Jaws Very Fine Angled Serrated Jaws	
	5005-64	90° Angled Jaws Very Fine Angled Serrated Jaws	



5005-00

Instrument is shown approximate size



SCANLAN®
Hartman Mosquito Forceps

Instrument jaws are shown approximate size

	Cat. No.	Description	Total Length
	5005-00	Curved Jaws	3 7/8" (9.8 cm)
	5005-001	Straight Jaws	

Please check with your Scanlan Representative for Firm Sale status. Custom modifications available upon request.

For a complete listing of models visit... www.scanlaninternational.com







5005-02

Instrument is shown approximate size



SCANLAN®
Vascular Mosquito Forceps

Instrument jaws are shown approximate size

	Cat. No.	Description	Total Length
	5005-01	Straight Serrated Jaws	5" (12.7 cm)
	5005-02	Delicate Curved Serrated Jaws	4 3/4" (12 cm)
	5005-03	Curved Jaws	5" (12.7 cm)
	5005-82	Curved Jaws Sharp Grasping Serrations	5" (12.7 cm)
	5005-05	Full Curved Jaws	4 1/2" (11.5 cm)

Please Note...

Each Scanlan instrument is individually handcrafted to provide the surgeon with the highest quality, longest-lasting, precision instrument possible. Reflecting this unique process, all stated dimensions are approximate.

5005-86

Instrument is shown approximate size



Stainless Steel CLAMPS

SCANLAN®
Delicate Mosquito Forceps

Instrument jaws are shown approximate size

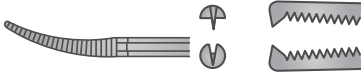
	Cat. No.	Description	Total Length
	5005-86	Very Fine Curved Jaws	5" (12.7 cm)
	5005-88	Curved Jaws 1 x 2 Teeth	

Please check with your Scanlan Representative for Firm Sale status. Custom modifications available upon request.
For a complete listing of models visit... www.scanlaninternational.com



5005-23

Instrument is shown approximate size



SCANLAN®
Vascular Forceps

Instrument jaws are shown approximate size		Cat. No.	Description	Total Length
	5005-13			5 1/2" (14 cm)
	5005-23	Curved Serrated Jaws		6 1/2" (16.5 cm)
	5005-33			7 1/4" (18.5 cm)
	5005-15			5 1/3" (13.7 cm)
	5005-25	Full Curved Serrated Jaws		6 1/4" (16 cm)
	5005-35			7" (18 cm)
	5005-37	Straight Jaws 1 x 2 Teeth		7" (18 cm)
	5005-39	Curved Jaws 1 x 2 Teeth		7" (18 cm)

Please Note...

Each Scanlan instrument is individually handcrafted to provide the surgeon with the highest quality, longest-lasting, precision instrument possible. Reflecting this unique process, all stated dimensions are approximate.

5005-43

Instrument is shown approximate size



Stainless Steel CLAMPS

SCANLAN®
Adson Forceps

Instrument jaws are shown approximate size

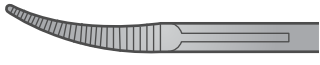
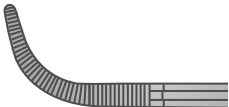
	Cat. No.	Description	Total Length
	5005-43	Curved Serrated Jaws	7" (18 cm)
	5005-45	Full Curved Serrated Jaws	

Please check with your Scanlan Representative for Firm Sale status. Custom modifications available upon request.
For a complete listing of models visit... www.scanlaninternational.com



5005-47

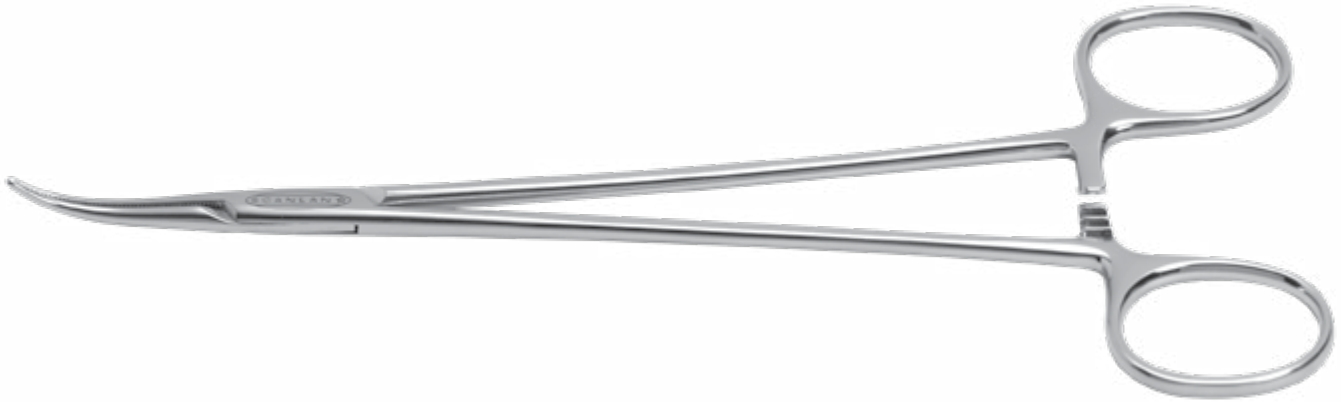

SCANLAN®
Bengolea Forceps

Instrument jaws are shown approximate size

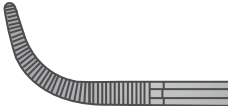
	Cat. No.	Description	Total Length
	5005-47	Curved Serrated Jaws	8" (20 cm)
	5005-51		9 1/2" (24 cm)
	5005-49	Full Curved Serrated Jaws	7 3/4" (19.5 cm)
	5005-53		9" (23 cm)

Please Note...

Each Scanlan instrument is individually handcrafted to provide the surgeon with the highest quality, longest-lasting, precision instrument possible. Reflecting this unique process, all stated dimensions are approximate.

4447-07

Instrument is shown approximate size



Stainless Steel CLAMPS

SCANLAN®
Crafoord Artery Forceps

Instrument jaws are shown approximate size

	Cat. No.	Description	Total Length
	4447-07	Curved Serrated Jaws	7" (18 cm)
	4447-09		9 1/4" (23.5 cm)

Please check with your Scanlan Representative for Firm Sale status. Custom modifications available upon request.
For a complete listing of models visit... www.scanlaninternational.com





SCANLAN®
DeBakey Cooley Forceps
 Carmalt Jaws with Cross Hatch Tips

Instrument jaws are shown approximate size

	Cat. No.	Description	Total Length
	4375-08	Curved Jaws	7 1/2" (19 cm)
	4375-09		9" (23 cm)
	4375-10		10" (25.4 cm)
	4375-11		11" (28 cm)
	4375-12		12" (30.5 cm)
	4375-14		14" (35.6 cm)

Please Note...

Each Scanlan instrument is individually handcrafted to provide the surgeon with the highest quality, longest-lasting, precision instrument possible. Reflecting this unique process, all stated dimensions are approximate.

4377-08

Stainless Steel CLAMPS



SCANLAN®
DeBakey Cooley Forceps
 Carmalt Jaws with Cross Hatch Tips

Instrument jaws are shown approximate size

	Cat. No.	Description	Total Length
	4377-08	Right Angle Jaws	7 1/2" (19 cm)
	4377-09		9" (23 cm)
	4377-11		11" (28 cm)
	4377-12		12" (30.5 cm)

Please check with your Scanlan Representative for Firm Sale status. Custom modifications available upon request.
 For a complete listing of models visit... www.scanlaninternational.com



Stainless Steel CLAMPS

4377-30



4377-28



SCANLAN®

MacDougall Clamp

Carmalt Jaws with Cross Hatch Tips

Instrument jaws are shown approximate size

	Cat. No.	Description	Total Length
	4377-28	Shanks Angled Left	12" (30.5 cm)
	4377-30	Shanks Angled Right	

Please Note...

Each Scanlan instrument is individually handcrafted to provide the surgeon with the highest quality, longest-lasting, precision instrument possible. Reflecting this unique process, all stated dimensions are approximate.

4545-09



Stainless Steel CLAMPS

SCANLAN®
Prostatectomy Clamp

Cat. No.	Description	Total Length
4545-09	45° Angled Babcock Jaws 8 mm Width Jaws Curved Shanks	9" (23 cm)

Haemostats | Specialty | Allis Intestinal

4635-06

Instrument is shown approximate size



SCANLAN®
Allis Intestinal Clamp

Cat. No.	Description	Total Length
4635-06	4 mm Width Jaws	6" (15 cm)

Please check with your Scanlan Representative for Firm Sale status. Custom modifications available upon request.

For a complete listing of models visit... www.scanlaninternational.com



Stainless Steel CLAMPS

1001-54

Instrument is shown approximate size



SCANLAN®

Smith Leifer Vasectomy Forceps

Cat. No.	Description	Total Length
1001-54	Sharp Tips	7" (18 cm)

Please Note...

Each Scanlan instrument is individually handcrafted to provide the surgeon with the highest quality, longest-lasting, precision instrument possible. Reflecting this unique process, all stated dimensions are approximate.



TITANIUM FORCEPS

LEGACY Round Handle Forceps

Platform Ring Tips 3.2
 Platform DIAMOND DUST™ Tips 3.2
 DeBakey Tips 3.3
 1x2 Teeth 3.4

LEGACY SCAN-II® Handle Forceps

Platform Ring Tips 3.5
 Platform DIAMOND DUST™ Tips 3.5
 DeBakey Tips 3.6
 1x2 Teeth 3.7

LEGACY Bayonet Style Forceps

Round Handle 3.8
 SCAN-II® Handle 3.8

Round Handle Forceps

Ring Tips 3.9
 DIAMOND DUST™ Tips 3.10
 DeBakey Micro 3.13

Flat Handle Forceps

Platform Ring Tips 3.14
 DIAMOND DUST™ Tips 3.15
 DeBakey Tips 3.16
 1X2 Teeth 3.18
 Bayonet Style 3.19

STAINLESS STEEL

Round Handle

Ring Tips 3.21
 Platform DIAMOND DUST™ Tips 3.23
 DIAMOND DUST™ Tips 3.26
 DeBakey Tips 3.27
 1x2 Teeth 3.28
 Needle Pulling Tissue Forceps 3.28

Flat Handle

Gerald Ring Tips 3.29
 Gerald DIAMOND DUST™ Tips 3.29
 Gilles Forceps 3.30
 Jewelers Forceps 3.31
 DeBakey Tips 3.32
 Gerald Serrated Tips 3.33
 1x2 Teeth 3.34
 Serrated Tips 3.35
 Brophy Tissue Forceps 3.36
 Suction Forceps 3.36
 Resano Valve Forceps 3.37
 Cushing Forceps 3.38
 Needle Pulling Tissue Forceps 3.38
 Bayonet Style 3.39



Forceps Modifications

FORCEPS

Modification	Description
904	Angle jaws/tips
904A	Angle and cut down jaws/tips
905	Cut down jaws/tips
905E	Cut down jaws/tips 0.4 mm
905TC	Cut down carbon-inlay jaws/tip
915	Gold plating
921	Grasping modification
923	Satin finish instrument
924	Tension modification
929	Special etching
971	Lengthen instrument
973	Shorten instrument



4004-79



4004-79 with modifications 971



3003-05



4004-97



3003-05 with modifications 904



4004-97 with modifications 904



4004-84



4004-84 with modifications 905

Please Note...

Each Scanlan instrument is individually handcrafted to provide the surgeon with the highest quality, longest-lasting, precision instrument possible. Reflecting this unique process, all stated dimensions are approximate.



Features of *LEGACY* Titanium Forceps

Titanium FORCEPS

Unique 10 mm Diameter and Extended Knurling

- Provides the titanium instruments with the optimized weight and balance.
- The extended knurling provides more surface area for the surgeon to grasp the instrument.

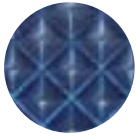

Perfect-Pyramid™
Provides a secure grasp.

Non-Magnetic

The properties of titanium prevent the needles from clinging to the instrument.



Never Shear™ Dual Guide™

- Prevents the tips from scissoring
- Prevents tissue from shearing

Diamond-Dust™

Securely and delicately grips the needles to prevent slippage and any damage to the needle.



SCAN-II® Handle

Revolutionary design that features a flat surface for control with round knurled sides for a secured grip and the ability to roll the instrument during procedures.



Round Handle

The original 10 mm round design provides the surgeon with a secure grip and the ability to roll the instrument during procedures.

Dual Guide™ Patent No. 8,147,512

The Never Shear™ Dual Guide™ design was developed in cooperation with John D. Puskas, MD

Patent Pending SCAN-II® Handle Design



Platform Ring Tips | LEGACY | Round Handle

Titanium FORCEPS

3003-922

Instrument is shown approximate size



SCANLAN® LEGACY Micro Forceps

Round Handle | Never Shear™ Dual Guide™ | 10 mm, Extended Knurling

Tip (enlarged to show detail)	Cat. No.	Description	Total Length
	3003-922	1.0 mm Straight DIAMOND DUST™ Platform Ring Tips	7 1/8" (18.1 cm)
	3003-924		8 1/4" (21 cm)
	3003-926		9" (23 cm)
	3003-928		10" (25.4 cm)

SCANLAN®

Platform DIAMOND DUST™ Tips | LEGACY | Round Handle

3003-914



SCANLAN® LEGACY Micro Forceps

Round Handle | Never Shear™ Dual Guide™ | 10 mm Diameter, Extended Knurling

Tip (enlarged to show detail)	Cat. No. 0.5 mm Tips	Cat. No. 1.0 mm Tips	Description	Total Length
	3003-902	3003-912	Straight DIAMOND DUST™ Platform Tips	7 1/8" (18.1 cm)
	3003-904	3003-914		8 1/4" (21 cm)
	3003-906	3003-916		9" (23 cm)
	3003-908	3003-918		10" (25.4 cm)

Please Note...

Each Scanlan instrument is individually handcrafted to provide the surgeon with the highest quality, longest-lasting, precision instrument possible. Reflecting this unique process, all stated dimensions are approximate.

Tapered DeBakey Tips | LEGACY | Round Handle

3003-934



Titanium FORCEPS

SCANLAN®

LEGACY Micro Forceps

Round Handle | Never Shear™ Dual Guide™ | 10 mm Diameter, Extended Knurling

Tip (enlarged to show detail)	Cat. No.	Description	Total Length
	3003-932	1.0 mm Straight Tapered DeBakey Tips	7 1/8" (18.1 cm)
	3003-934		8 1/4" (21 cm)
	3003-936		9" (23 cm)
	3003-938		10" (25.4 cm)

Please check with your Scanlan Representative for Firm Sale status. Custom modifications available upon request.
For a complete listing of models visit... www.scanlaninternational.com







Titanium FORCEPS



SCANLAN®

LEGACY Micro Forceps

Round Handle | Never Shear™ Dual Guide™ | 10 mm Diameter, Extended Knurling

Tip (enlarged to show detail)	Cat. No. 0.5 mm Tips	Cat. No. 1.0 mm Tips	Description	Total Length
 <p>Platform Tip 1X2 Micro Teeth</p>	3003-770		Puskas™ Straight DIAMOND DUST™ Platform Tips	7 1/8" (18.1 cm)
	3003-774	3003-778	1 x 2 Micro Teeth	8 1/4" (21 cm)
	3003-775		Puskas™ Curved DIAMOND DUST™ Platform Tips 1 x 2 Micro Teeth	8 1/4" (21 cm)
	3003-776	3003-779	Puskas™ Angled DIAMOND DUST™ Platform Tips 1 x 2 Micro Teeth	8 1/4" (21 cm)
	3003-780	3003-784	Straight DIAMOND DUST™ Platform Tips 1 x 2 Micro Teeth	9" (23 cm)
	3003-782	3003-786		10" (25.4 cm)

Please Note...

Each Scanlan instrument is individually handcrafted to provide the surgeon with the highest quality, longest-lasting, precision instrument possible. Reflecting this unique process, all stated dimensions are approximate.

Platform Ring Tips | LEGACY | SCAN-II® Handle

3003-942

Instrument is shown approximate size



Titanium FORCEPS

SCANLAN®

LEGACY Micro Forceps

SCAN-II® Handle | Never Shear™ Dual Guide™ | 10 mm, Extended Knurling

Tip (enlarged to show detail)	Cat. No.	Description	Total Length
	NEW 3003-942	1.0 mm Straight DIAMOND DUST™ Platform Ring Tips	7 1/8" (18.1 cm)
	NEW 3003-944		8 1/4" (21 cm)
	NEW 3003-946		9" (23 cm)
	NEW 3003-948		10" (25.4 cm)

SCANLAN®

Platform DIAMOND DUST™ Tips | LEGACY | SCAN-II® Handle

3003-974



SCANLAN®

LEGACY Micro Forceps

SCAN-II® Handle | Never Shear™ Dual Guide™ | 10 mm Diameter, Extended Knurling

Tip (enlarged to show detail)	Cat. No. 0.5 mm Tips	Cat. No. 1.0 mm Tips	Description	Total Length
	NEW 3003-962	NEW 3003-972	Straight DIAMOND DUST™ Platform Tips	7 1/8" (18.1 cm)
	NEW 3003-964	NEW 3003-974		8 1/4" (21 cm)
	NEW 3003-966	NEW 3003-976		9" (23 cm)
	NEW 3003-968	NEW 3003-978		10" (25.4 cm)

Please check with your Scanlan Representative for Firm Sale status. Custom modifications available upon request.

For a complete listing of models visit... www.scanlaninternational.com



3003-952

Instrument is shown approximate size



SCANLAN®

LEGACY Micro Forceps

SCAN-II® Handle | Never Shear™ Dual Guide™ | 10 mm, Extended Knurling

Tip

(enlarged to show detail)

Tip	Cat. No.	Description	Total Length
 DeBakey Tip	NEW 3003-952	1.0 mm Straight Tapered DeBakey Tips	7 1/8" (18.1 cm)
	NEW 3003-954		8 1/4" (21 cm)
	NEW 3003-956		9" (23 cm)
	NEW 3003-958		10" (25.4 cm)

Please Note...

Each Scanlan instrument is individually handcrafted to provide the surgeon with the highest quality, longest-lasting, precision instrument possible. Reflecting this unique process, all stated dimensions are approximate.

Platform Tip, 1x2 Teeth | LEGACY | SCAN-II® Handle

3003-984



Titanium FORCEPS

SCANLAN®

LEGACY Micro Forceps

SCAN-II® Handle | Never Shear™ Dual Guide™ | 10 mm Diameter, Extended Knurling

Tip (enlarged to show detail)	Cat. No. 0.5 mm Tips	Cat. No. 1.0 mm Tips	Description	Total Length
	NEW 3003-980		Puskas™ Straight DIAMOND DUST™ Platform Tips	7 1/8" (18.1 cm)
	NEW 3003-984	NEW 3003-988	1 x 2 Micro Teeth	8 1/4" (21 cm)
	NEW 3003-985		Puskas™ Curved DIAMOND DUST™ Platform Tips	8 1/4" (21 cm)
	NEW 3003-986	NEW 3003-989	Puskas™ Angled DIAMOND DUST™ Platform Tips	8 1/4" (21 cm)
	NEW 3003-990	NEW 3003-994	Straight DIAMOND DUST™ Platform Tips	9" (23 cm)
	NEW 3003-992	NEW 3003-996	1 x 2 Micro Teeth	10" (25.4 cm)

Please check with your Scanlan Representative for Firm Sale status. Custom modifications available upon request.

For a complete listing of models visit... www.scanlaninternational.com



Bayonet Style | LEGACY | Round Handle

Titanium FORCEPS





3003-810



SCANLAN®

LEGACY Micro Forceps

Round Handle | Never Shear™ Dual Guide™ | Bayonet Style | 10 mm Diameter, Extended Knurling

Tip (enlarged to show detail)	Cat. No. 0.5 mm Tips	Cat. No. 1.0 mm Tips	Description	Total Length
Platform Ring Tip 		3003-804	Straight DIAMOND DUST™ Platform Ring Tips	8 3/4" (22 cm)
Platform Tip 	3003-816	3003-818	Straight DIAMOND DUST™ Platform Tips	
DeBakey Tip 		3003-806	Straight Tapered DeBakey Tips	
Platform Tip 1X2 Micro Teeth 	3003-810		Puskas™ Straight DIAMOND DUST™ Tips 1 x 2 Micro Teeth	

SCANLAN®

Bayonet Style | LEGACY | SCAN-II® Handle

3003-820



SCANLAN®

LEGACY Micro Forceps

SCAN-II® Handle | Never Shear™ Dual Guide™ | Bayonet Style | 10 mm Diameter, Extended Knurling

Tip (enlarged to show detail)	Cat. No. 0.5 mm Tips	Description	Total Length
Platform Tip 1X2 Micro Teeth 	NEW 3003-820	Puskas™ Straight DIAMOND DUST™ Tips 1 x 2 Micro Teeth	8 3/4" (22 cm)

Please Note...

Each Scanlan instrument is individually handcrafted to provide the surgeon with the highest quality, longest-lasting, precision instrument possible. Reflecting this unique process, all stated dimensions are approximate.





Micro Platform Ring Tips | Titanium

3003-160



Titanium FORCEPS

SCANLAN®
Micro Forceps
 Round Handle

Tip (enlarged to show detail)	Cat. No.	Description	Total Length
	3003-164	1 mm Straight DIAMOND DUST™ Ring Tips	6" (15 cm)
	3003-166	2 mm Straight DIAMOND DUST™ Ring Tips	
	3003-160	1 mm Straight DIAMOND DUST™ Ring Tips	7 1/4" (18.5 cm)
	3003-162	2 mm Straight DIAMOND DUST™ Ring Tips	

3003-720

Instrument is shown approximate size



SCANLAN®
Dennis Micro Forceps
 Round Handle | Counterbalanced

Tip (enlarged to show detail)	Cat. No.	Description	Total Length
	3003-720	1 mm Straight DIAMOND DUST™ Ring Tips	7" (18 cm)
	3003-724		8 1/4" (21 cm)
	3003-726		9" (23 cm)
	3003-728		10" (25.4 cm)

Please check with your Scanlan Representative for Firm Sale status. Custom modifications available upon request.
 For a complete listing of models visit... www.scanlaninternational.com



3303-452

Instrument is shown approximate size



SCANLAN®
Super-Micro Fine
 Round Handle

Tip (enlarged to show detail)	Cat. No.	Description	Total Length
	NEW 3303-452	Curved 0.3 mm DIAMOND DUST™ Platform Tips	5" (12.7 cm)
	NEW 3303-470	Straight 0.3 mm DIAMOND DUST™ Platform Tips	7 1/4" (18.5 cm)
	NEW 3303-472	Curved 0.3 mm DIAMOND DUST™ Platform Tips	

Please Note...

Each Scanlan instrument is individually handcrafted to provide the surgeon with the highest quality, longest-lasting, precision instrument possible. Reflecting this unique process, all stated dimensions are approximate.



Micro Platform DIAMOND DUST™ Tips | Round Handle

3003-154

Instrument is shown approximate size



Titanium FORCEPS

SCANLAN®

Micro Suture Tying Forceps

Round Handle

Tip (enlarged to show detail)	Cat. No.	Description	Total Length
	3003-150	Straight DIAMOND DUST™ Platform Tips	4 3/4" (12 cm)
	3003-152	Curved DIAMOND DUST™ Platform Tips	
	3003-154	Straight DIAMOND DUST™ Platform Tips	6" (15 cm)
	3003-154-3	0.3 mm Straight DIAMOND DUST™ Platform Tips Gerald Type Taper	
	3003-154-4	0.4 mm Straight DIAMOND DUST™ Platform Tips	
	3003-156	Curved DIAMOND DUST™ Platform Tips	
	3003-156-3	0.3 mm Curved DIAMOND DUST™ Platform Tips Gerald Type Taper	
	3003-156-4	0.4 mm Curved DIAMOND DUST™ Platform Tips	

Please check with your Scanlan Representative for Firm Sale status. Custom modifications available upon request.

For a complete listing of models visit... www.scanlaninternational.com





SCANLAN®
Micro Forceps
Round Handle

Tip (enlarged to show detail)	Cat. No.	Description	Total Length
	3003-158	Straight DIAMOND DUST™ Platform Tips	7 1/4" (18.5 cm)
	3003-158-3	0.3 mm Straight DIAMOND DUST™ Platform Tips Gerald Type Taper	
	3003-158-4	0.4 mm Straight DIAMOND DUST™ Platform Tips	
	3003-159	Curved DIAMOND DUST™ Platform Tips	
	3003-159-3	0.3 mm Curved DIAMOND DUST™ Platform Tips Gerald Type Taper	
	3003-159-4	0.4 mm Curved DIAMOND DUST™ Platform Tips	
	3003-158-8	Straight DIAMOND DUST™ Platform Tips	8 1/4" (21 cm)
	3003-159-8	Curved DIAMOND DUST™ Platform Tips	
	3003-158-9	Straight DIAMOND DUST™ Platform Tips	9" (23 cm)
	3003-158-10	Straight DIAMOND DUST™ Platform Tips	10" (25.4 cm)
	3003-159-10	Curved DIAMOND DUST™ Platform Tips	

Please Note...

Each Scanlan instrument is individually handcrafted to provide the surgeon with the highest quality, longest-lasting, precision instrument possible. Reflecting this unique process, all stated dimensions are approximate.

Micro Platform DIAMOND DUST™ Tips | Round Handle

3003-712

Titanium FORCEPS







SCANLAN®

Dennis Micro Forceps

Round Handle | Counterbalanced

Tip

(enlarged to show detail)

Tip (enlarged to show detail)	Cat. No.	Description	Total Length
	3003-710	Straight DIAMOND DUST™ Platform Tips	7" (18 cm)
	3003-712	Curved DIAMOND DUST™ Platform Tips	
	3003-714	Straight DIAMOND DUST™ Platform Tips	8 1/4" (21 cm)
	3003-716	Curved DIAMOND DUST™ Platform Tips	

SCANLAN®

Micro DeBakey Tips | Round Handle

3003-730



SCANLAN®

DeBakey Micro Forceps

Round Handle

Tip

(enlarged to show detail)

Tip (enlarged to show detail)	Cat. No.	Description	Total Length
	3003-730	1 mm Straight DeBakey Tips	7 1/8" (18.1 cm)

Please check with your Scanlan Representative for Firm Sale status. Custom modifications available upon request.

For a complete listing of models visit... www.scanlaninternational.com



3003-750

Instrument is shown approximate size



SCANLAN®
Gerald Forceps
 Flat Handle

Tip (enlarged to show detail)	Cat. No.	Description	Total Length
	3003-750	1 mm Straight	7" (18 cm)
	3003-752	DIAMOND DUST™ Platform Ring Tips	8" (20 cm)

Please Note...

Each Scanlan instrument is individually handcrafted to provide the surgeon with the highest quality, longest-lasting, precision instrument possible. Reflecting this unique process, all stated dimensions are approximate.

Super-Micro Fine DIAMOND DUST™ Tips | Flat Handle

3303-410

Instrument is shown approximate size



Titanium FORCEPS

SCANLAN®
Super-Micro Fine
Flat Handle

Tip (enlarged to show detail)	Cat. No.	Description	Total Length
	NEW 3303-410	Straight 0.3 mm DIAMOND DUST™ Platform Tips	5" (12.7 cm)
	NEW 3303-430	Straight 0.3 mm DIAMOND DUST™ Platform Tips	7 1/4" (18.5 cm)
	NEW 3303-434	Angled 0.3 mm DIAMOND DUST™ Tips	

Gerald Platform DIAMOND DUST™ Tips | Flat Handle

3003-760

Instrument is shown approximate size



SCANLAN®
Gerald Forceps
Flat Handle

Tip (enlarged to show detail)	Cat. No.	Description	Total Length
	3003-760	Straight DIAMOND DUST™ Platform Tips	7" (18 cm)
	3003-762		8" (20 cm)

Please check with your Scanlan Representative for Firm Sale status. Custom modifications available upon request.

For a complete listing of models visit... www.scanlaninternational.com



Gerald DeBakey Tips | Titanium

Titanium FORCEPS

3003-740

Instrument is shown approximate size



SCANLAN®

Gerald DeBakey Forceps

Flat Handle

Tip

(enlarged to show detail)

	Cat. No.	Description	Total Length
	3003-740	1 mm Straight DeBakey Tips	7" (18 cm)
	3003-742		8" (20 cm)

SCANLAN®

DeBakey Tips | Titanium

3003-051



SCANLAN®

DeBakey Dissecting Forceps

Flat Handle

Tip

(enlarged to show detail)

	Cat. No.	Description	Total Length
	NEW 3003-051	1.2 mm Straight DeBakey, 1 x 2 Micro Teeth	7 3/4" (19.5 cm)
	NEW 3003-071		9 1/2" (24 cm)

Please Note...

Each Scanlan instrument is individually handcrafted to provide the surgeon with the highest quality, longest-lasting, precision instrument possible. Reflecting this unique process, all stated dimensions are approximate.

3003-02

Instrument is shown approximate size





SCANLAN®

DeBakey Dissecting Forceps

Flat Handle

Tip

(enlarged to show detail)

	Cat. No.	Description	Total Length
	3003-03		6" (15 cm)
	3003-05	1 mm Straight DeBakey Tips	7 3/4" (19.5 cm)
	3003-07		9 1/2" (24 cm)
	3003-02		6" (15 cm)
	3003-04	2 mm Straight DeBakey Tips	7 3/4" (19.5 cm)
	3003-06		9 1/2" (24 cm)

Please check with your Scanlan Representative for Firm Sale status. Custom modifications available upon request.

For a complete listing of models visit... www.scanlaninternational.com



Titanium FORCEPS

3003-09

Instrument is shown approximate size



SCANLAN®
Cushing Forceps
Flat Handle

Tip (enlarged to show detail)	Cat. No.	Description	Total Length
	3003-09	1 mm Straight Serrated Tips Fluted Handle	7" (18 cm)

SCANLAN®

Gerald 1x2 Micro Teeth | Titanium

3003-738

Instrument is shown approximate size



SCANLAN®
Gerald Forceps
Flat Handle

Tip (enlarged to show detail)	Cat. No.	Description	Total Length
	3003-738	Straight Delicate 1 x 2 Fine Teeth	7" (18 cm)

SCANLAN®

Resano Valve | Titanium

3003-794



SCANLAN®
Resano Valve Forceps
Flat Handle

Tip (enlarged to show detail)	Cat. No.	Description	Total Length
	3003-794	Multi-Toothed Tip	9" (23 cm)



3003-823

Titanium FORCEPS



SCANLAN®
Tumor Grasping Forceps

Flat Handle

Tip (enlarged to show detail)	Cat. No.	Description	Total Length
	3003-823	3 mm Concave Serrated Tips	8 3/4" (22 cm)
	3003-825	5 mm Concave Serrated Tips	

3003-832



SCANLAN®
Micro Forceps

Flat Handle

Tip (enlarged to show detail)	Cat. No.	Description	Total Length
	3003-832	0.7 mm Straight Tips 1 x 2 Fine Teeth	8 3/4" (22 cm)

Please Note...
Each Scanlan instrument is individually handcrafted to provide the surgeon with the highest quality, longest-lasting, precision instrument possible. Reflecting this unique process, all stated dimensions are approximate.

Please check with your Scanlan Representative for Firm Sale status. Custom modifications available upon request.
For a complete listing of models visit... www.scanlaninternational.com



Titanium FORCEPS

3003-841



SCANLAN®
Micro Forceps
Flat Handle

Tip
(enlarged to show detail)

	Cat. No.	Description	Total Length
	3003-840	0.3 mm Curved Up DIAMOND DUST™ Tips	8 3/4" (22 cm)
	3003-841	0.3 mm 45° Angle DIAMOND DUST™ Tips	
	3003-842	0.3 mm Straight DIAMOND DUST™ Tips	
	3003-843	0.3 mm Straight Smooth Tips	
	3003-846	0.7 mm Straight DIAMOND DUST™ Tips	
	3003-847	0.7 mm Straight Smooth Tips	

3003-850



SCANLAN®
Micro Forceps
Flat Handle

Tip
(enlarged to show detail)

	Cat. No.	Description	Total Length
	3003-850	1 mm Straight Smooth Ring Tips	8 3/4" (22 cm)
	3003-851	1 mm Straight DIAMOND DUST™ Ring Tips	

Please Note...

Each Scanlan instrument is individually handcrafted to provide the surgeon with the highest quality, longest-lasting, precision instrument possible. Reflecting this unique process, all stated dimensions are approximate.

Micro Ring Tips | Round Handle

4004-220

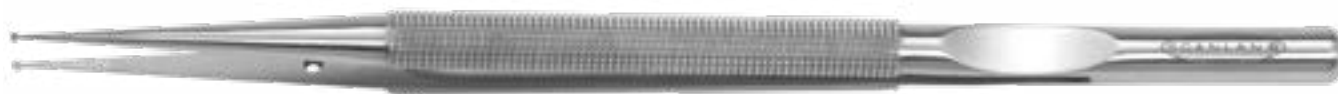

SCANLAN®
Dennis Micro Forceps
 Round Handle | Counterbalanced

Stainless Steel FORCEPS

Tip (enlarged to show detail)	Cat. No.	Description	Total Length
	4004-216	1 mm Straight DIAMOND DUST™ Ring Tips	6" (15 cm)
	4004-217	1 mm Curved DIAMOND DUST™ Ring Tips	
	4004-320	2 mm Straight DIAMOND DUST™ Ring Tips	7" (18 cm)
	4004-330	2.5 mm Straight DIAMOND DUST™ Ring Tips	
	4004-220	1 mm Straight DIAMOND DUST™ Ring Tips	7 1/4" (18.5 cm)
	4004-221	1 mm Curved DIAMOND DUST™ Ring Tips	
	4004-224	1 mm Straight DIAMOND DUST™ Ring Tips	8 1/4" (21 cm)
	4004-225	1 mm Curved DIAMOND DUST™ Ring Tips	
	4004-226	1 mm Straight DIAMOND DUST™ Ring Tips	9" (23 cm)
	4004-227	1 mm Curved DIAMOND DUST™ Ring Tips	
	4004-228	1 mm Straight DIAMOND DUST™ Ring Tips	10" (25.4 cm)

Please check with your Scanlan Representative for Firm Sale status. Custom modifications available upon request.
 For a complete listing of models visit... www.scanlaninternational.com



4004-280

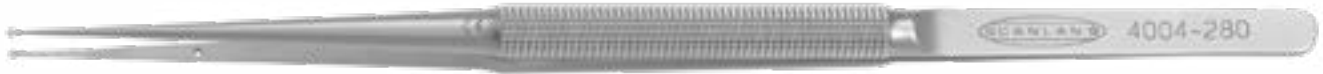

SCANLAN®
Micro Forceps
 Round Handle | Lightweight

Tip (enlarged to show detail)	Cat. No.	Description	Total Length
	4004-280	1 mm Straight DIAMOND DUST™ Platform Ring Tips	7 1/8" (18.1 cm)
	4004-282		8 1/4" (21 cm)

4004-250



SCANLAN®
Micro Forceps
 Round Handle | Lightweight

Tip (enlarged to show detail)	Cat. No.	Description	Total Length
	4004-250	1 mm Straight DIAMOND DUST™ Ring Tips	7 1/8" (18.1 cm)
	4004-251	1 mm Curved DIAMOND DUST™ Ring Tips	
	4004-254	2.5 mm Straight DIAMOND DUST™ Ring Tips	
	4004-252	1 mm Straight DIAMOND DUST™ Ring Tips	8 1/4" (21 cm)
	4004-253	1 mm Curved DIAMOND DUST™ Ring Tips	
	4004-256	2.5 mm Straight DIAMOND DUST™ Ring Tips	

Small Plastic Platform DIAMOND DUST™ Tips | Round Handle

4004-02
Instrument is shown approximate size



Stainless Steel FORCEPS

SCANLAN®
Suture Tying Forceps
Round Handle

Tip (enlarged to show detail)	Cat. No.	Description	Total Length
	4004-01	Straight DIAMOND DUST™ Platform Tips	4 3/4" (12 cm)
	4004-02	Curved DIAMOND DUST™ Platform Tips	4 3/4" (12 cm)
	4004-03	Straight DIAMOND DUST™ Platform Tips	5 1/2" (14 cm)
	4004-04	Curved DIAMOND DUST™ Platform Tips	5 1/2" (14 cm)
	4004-03-3A	45° Angled 0.3 mm DIAMOND DUST™ Tips	5 1/2" (14 cm)

Please Note...
Each Scanlan instrument is individually handcrafted to provide the surgeon with the highest quality, longest-lasting, precision instrument possible. Reflecting this unique process, all stated dimensions are approximate.

Please check with your Scanlan Representative for Firm Sale status. Custom modifications available upon request.
For a complete listing of models visit... www.scanlaninternational.com



4004-260

Stainless Steel FORCEPS

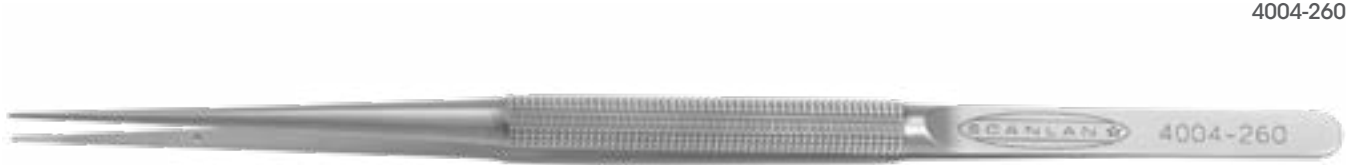

SCANLAN®
Micro Forceps
 Round Handle | Lightweight

Tip (enlarged to show detail)	Cat. No.	Description	Total Length
	4004-260	Straight DIAMOND DUST™ Platform Tips	7 1/8" (18.1 cm)
	4004-261	Curved DIAMOND DUST™ Platform Tips	
	4004-262	Straight DIAMOND DUST™ Platform Tips	8 1/4" (21 cm)
	4004-263	Curved DIAMOND DUST™ Platform Tips	

Please Note...

Each Scanlan instrument is individually handcrafted to provide the surgeon with the highest quality, longest-lasting, precision instrument possible. Reflecting this unique process, all stated dimensions are approximate.

Micro Platform DIAMOND DUST™ Tips | Round Handle

4004-95

Instrument is shown approximate size

Stainless Steel FORCEPS

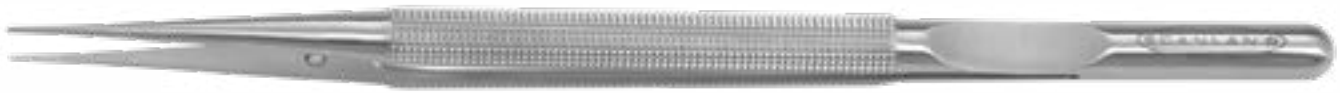

SCANLAN®
Dennis Micro Forceps
 Round Handle | Counterbalanced

Tip (enlarged to show detail)	Cat. No.	Description	Total Length
	4004-210	Straight DIAMOND DUST™ Platform Tips	6" (15 cm)
	4004-212	Curved DIAMOND DUST™ Platform Tips	
	4004-95	Straight DIAMOND DUST™ Platform Tips	7" (18 cm)
	4004-96	Curved DIAMOND DUST™ Platform Tips	
	4004-98	Straight DIAMOND DUST™ Platform Tips	8 1/4" (21 cm)
	4004-99	Curved DIAMOND DUST™ Platform Tips	
	4004-204	Straight DIAMOND DUST™ Platform Tips	10" (25.4 cm)
	4004-206	Curved DIAMOND DUST™ Platform Tips	

Please check with your Scanlan Representative for Firm Sale status. Custom modifications available upon request.
 For a complete listing of models visit... www.scanlaninternational.com





SCANLAN®
Micro Forceps
 Round Handle | Lightweight

Tip (enlarged to show detail)	Cat. No.	Description	Total Length
	4004-97	Straight DIAMOND DUST™ Tips	7 1/8" (18.1 cm)
	4004-97A	Curved DIAMOND DUST™ Tips	7 1/8" (18.1 cm)
	4004-97-3A	0.3 mm 45° Angled DIAMOND DUST™ Tips	7 1/4" (18.5 cm)

Please Note...

Each Scanlan instrument is individually handcrafted to provide the surgeon with the highest quality, longest-lasting, precision instrument possible. Reflecting this unique process, all stated dimensions are approximate.

Dennis Micro DeBakey Tips | Round Handle

4004-272

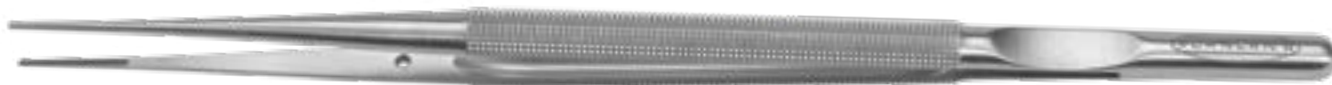

SCANLAN®
Dennis Micro Forceps
 Round Handle | Counterbalanced

Tip (enlarged to show detail)	Cat. No.	Description	Total Length
	4004-270	1 mm Straight DeBakey Tips	7" (18 cm)
	4004-272		8 1/4" (21 cm)

Stainless Steel FORCEPS

DeBakey Tips | Round Handle

4004-232



SCANLAN®
Micro Forceps
 Round Handle | Lightweight

Tip (enlarged to show detail)	Cat. No.	Description	Total Length
	4004-230	1 mm Straight DeBakey Tips	7 1/8" (18.1 cm)
	4004-232		8 1/4" (21 cm)

Please check with your Scanlan Representative for Firm Sale status. Custom modifications available upon request.
 For a complete listing of models visit... www.scanlaninternational.com



Micro 1x2 Tips | Round Handle

Stainless Steel FORCEPS

4004-235



SCANLAN®

Dennis Micro Forceps

Round Handle | Counterbalanced

Tip (enlarged to show detail)	Cat. No.	Description	Total Length
	4004-305	Straight DIAMOND DUST™ Tips 1 x 2 Teeth	7" (18 cm)
	4004-235		7 1/8" (18.1 cm)

SCANLAN®

Needle Pulling Tissue Forceps | Round Handle

4004-268

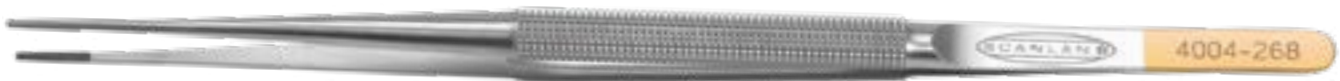

SCANLAN®

DeBakey Needle Pulling Tissue Forceps

Round Handle (Gold Handle) | Lightweight

Tip (enlarged to show detail)	Cat. No.	Description	Total Length
	4004-266	2 mm Straight Carbon-Inlay with DeBakey Tips	7 1/4" (18.5 cm)
	4004-268	1 mm Straight Fine Carbon-Inlay with DeBakey Tips	7 1/4" (18.5 cm)
	4004-269		8 1/4" (21 cm)

Please Note...

Each Scanlan instrument is individually handcrafted to provide the surgeon with the highest quality, longest-lasting, precision instrument possible. Reflecting this unique process, all stated dimensions are approximate.

Please check with your Scanlan Representative for Firm Sale status. Custom modifications available upon request.

For a complete listing of models visit... www.scanlaninternational.com

Gerald Ring Tips | Flat Handle



Stainless Steel FORCEPS

SCANLAN®
Gerald Forceps
 Flat Handle

Tip (enlarged to show detail)	Cat. No.	Description	Total Length
	4004-244	1 mm Straight DIAMOND DUST™ Ring Tips	7" (18 cm)
	4004-245	1 mm Curved DIAMOND DUST™ Ring Tips	7" (18 cm)
	4004-350	1 mm Straight DIAMOND DUST™ Platform Ring Tips Without Guide Pin	8 1/4" (21 cm)

Gerald DIAMOND DUST™ Tips | Flat Handle



SCANLAN®
Gerald Forceps
 Flat Handle

Tip (enlarged to show detail)	Cat. No.	Description	Total Length
	4004-246	1 mm Straight DIAMOND DUST™ Tips	7" (18 cm)
	4004-346	1 mm Straight DIAMOND DUST™ Platform Tips	7" (18 cm)
	4004-248	1 mm Straight DIAMOND DUST™ Tips	8" (20 cm)









DIAMOND DUST™ Tips | Flat Handle

4004-88

Stainless Steel FORCEPS

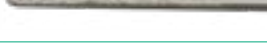

SCANLAN®
Thumb Forceps
Flat Handle

Tip (enlarged to show detail)	Cat. No.	Description	Total Length
	4004-80	1 mm Straight DIAMOND DUST™ Tips	6 1/4" (16 cm)
	4004-84	1 mm Straight DIAMOND DUST™ Tips	7 1/8" (18.8 cm)
	4004-86	2 mm Straight DIAMOND DUST™ Tips	
	4004-88	1 mm Straight DIAMOND DUST™ Tips	8" (20 cm)
	4004-90	2 mm Straight DIAMOND DUST™ Tips	
	4004-92	1 mm Straight DIAMOND DUST™ Tips	9 3/4" (24.8 cm)
	4004-94	2 mm Straight DIAMOND DUST™ Tips	

Gilles Forceps DIAMOND DUST™ Tips | Flat Handle

4004-65



SCANLAN®
Gilles Forceps
Flat Handle

Tip (enlarged to show detail)	Cat. No.	Description	Total Length
	4004-65	1 mm Straight DIAMOND DUST™ Tips	8" (20 cm)

Small Plastic DIAMOND DUST™ Tips | Flat Handle

4004-19

Instrument is shown approximate size



Stainless Steel FORCEPS

SCANLAN®
Jewelers Forceps
 Sharp Flat Tips | Flat Handle

Tip
 (enlarged to show detail)

	Cat. No.	Description	Total Length
	4004-05	Straight Smooth Tips	4 1/4" (11 cm)
	4004-07	Straight DIAMOND DUST™ Tips	4 1/4" (11 cm)
	4004-17	Straight Smooth Tips	5 1/8" (13 cm)
	4004-19	Straight DIAMOND DUST™ Tips	5 1/8" (13 cm)
	4004-23	45° Angled DIAMOND DUST™ Tips	5 1/8" (13 cm)

Please Note...
 Each Scanlan instrument is individually handcrafted to provide the surgeon with the highest quality, longest-lasting, precision instrument possible. Reflecting this unique process, all stated dimensions are approximate.

Please check with your Scanlan Representative for Firm Sale status. Custom modifications available upon request.
 For a complete listing of models visit... www.scanlaninternational.com



4004-43



4004-44



SCANLAN®
DeBakey Forceps
Flat Handle

Tip (enlarged to show detail)	Cat. No.	Description	Total Length
	4004-40	1 mm Straight DeBakey Tips	6" (15 cm)
	4004-42	2 mm Straight DeBakey Tips	
	4004-43	1 mm Straight DeBakey Tips	7 3/4" (19.5 cm)
	4004-44	1 mm Straight DeBakey Tips Fluted Handle	
	4004-45	2 mm Straight DeBakey Tips	
	4004-46	2 mm Straight DeBakey Tips Fluted Handle	
	4004-47	2 mm 25° Angled DeBakey Tips	
	4004-45A	2.7 mm Straight DeBakey Tips Wide Serration Handle	
	4004-48	1.5 mm Straight DeBakey Tips	
	4004-50	2 mm Straight DeBakey Tips	9 1/2" (24 cm)
	4004-50A	2.7 mm Straight DeBakey Tips Wide Serration Handle	
	4004-50B	3.2 mm Straight DeBakey Tips Wide Serration Handle	
	4004-52	1.5 mm Straight DeBakey Tips	12" (30.5 cm)
	4004-54	2 mm Straight DeBakey Tips	

Gerald DeBakey Tips | Flat Handle

4004-242



Stainless Steel FORCEPS

SCANLAN®
Gerald DeBakey Forceps
 Flat Handle

Tip (enlarged to show detail)	Cat. No.	Description	Total Length
	4004-240	1 mm Straight DeBakey Tips	7" (18 cm)
	4004-242	1 mm Straight DeBakey Tips	8" (20 cm)

Gerald Serrated Tips | Flat Handle

4004-76

Instrument is shown approximate size



SCANLAN®
Gerald Forceps
 Flat Handle

Tip (enlarged to show detail)	Cat. No.	Description	Total Length
	4004-76	1 mm Straight Serrated Tips	7" (18 cm)
	4004-77	1 mm Straight Cross-Serrated Tips	7 3/4" (19.5 cm)
	4004-79		10" (25.4 cm)
	4004-79-12	1.5 mm Straight Cross-Serrated Tips	12" (30.5cm)

Please Note...
 Each Scanlan instrument is individually handcrafted to provide the surgeon with the highest quality, longest-lasting, precision instrument possible. Reflecting this unique process, all stated dimensions are approximate.

Please check with your Scanlan Representative for Firm Sale status. Custom modifications available upon request.
 For a complete listing of models visit... www.scanlaninternational.com



Gerald 1 x 2 Teeth | Flat Handle



Stainless Steel FORCEPS

4004-238

Instrument is shown approximate size



SCANLAN®
Gerald Forceps
Flat Handle

Tip (enlarged to show detail)	Cat. No.	Description	Total Length
	4004-238	Straight Tips Delicate 1x2 Teeth	7" (18 cm)
	4004-239	Curved Tips Delicate 1x2 Teeth	7" (18 cm)





Adson Forceps 1 x 2 Teeth | Flat Handle

4004-29

Instrument is shown approximate size



SCANLAN®
Adson Forceps
Flat Handle

Tip (enlarged to show detail)	Cat. No.	Description	Total Length
	4004-25	1.2 mm Straight Serrated Tips	4 3/4" (12 cm)
	4004-27	1.2 mm Straight DIAMOND DUST™ Tips	
	4004-28	1.2 mm Straight Platform Tips 1x2 Teeth	
	4004-29	1.2 mm Straight 1x2 Teeth	

Brolí-Adson 1 x 2 Teeth | Flat Handle

4004-31

Instrument is shown approximate size



Stainless Steel FORCEPS

SCANLAN®
Brolí-Adson Forceps
 Flat Handle

Tip (enlarged to show detail)	Cat. No.	Description	Total Length
	4004-31	1.2 mm Straight Serrated Tips	6" (15 cm)
	4004-35	1.2 mm Straight 1x2 Teeth	

MacIndoe Forceps | Flat Handle

4004-63

Instrument is shown approximate size



SCANLAN®
McIndoe Forceps
 Flat Handle

Tip (enlarged to show detail)	Cat. No.	Description	Total Length
	4004-62	2 mm Straight Serrated Tips	6" (15 cm)
	4004-63	Straight Serrated Fine Tips 1x2 Teeth	6 1/4" (15.5 cm)

Please Note...
 Each Scanlan instrument is individually handcrafted to provide the surgeon with the highest quality, longest-lasting, precision instrument possible. Reflecting this unique process, all stated dimensions are approximate.

Please check with your Scanlan Representative for Firm Sale status. Custom modifications available upon request.
 For a complete listing of models visit... www.scanlaninternational.com



Brophy Tissue Forceps 1 x 2 Teeth | Flat Handle

Stainless Steel FORCEPS

3190-08



SCANLAN®
Brophy Tissue Forceps, Cardiovascular
 Flat Handle

Tip (enlarged to show detail)	Cat. No.	Description	Total Length
	3190-08	Straight Fine 1x2 Teeth	8" (20 cm)

Specialty Suction | Flat Handle

4004-125

Instrument is shown approximate size



SCANLAN®
Suction Forceps
 One Suction Cannula

Tip (enlarged to show detail)	Cat. No.	Description	Total Length
	4004-125	Broli-Adson Forceps 1.2 mm Straight Serrated Tips	6 3/4" (17 cm)
	4004-108	Potts-Smith Forceps Straight Serrated Tips	8" (20 cm)
	4004-124	DeBakey Forceps Straight Tips	8 1/2" (21.5 cm)

Please Note...

Each Scanlan instrument is individually handcrafted to provide the surgeon with the highest quality, longest-lasting, precision instrument possible. Reflecting this unique process, all stated dimensions are approximate.

4004-394

Stainless Steel FORCEPS



SCANLAN®
Resano Valve Forceps
 Flat Handle

Tip (enlarged to show detail)	Cat. No.	Description	Total Length
	4004-394	Multi-Toothed Tip	9" (23 cm)

Please check with your Scanlan Representative for Firm Sale status. Custom modifications available upon request.
 For a complete listing of models visit... www.scanlaninternational.com



Cushing Forceps | Flat Handle

Stainless Steel FORCEPS

4004-56

Instrument is shown approximate size



4004-57



SCANLAN®
Cushing Forceps
 Flat Handle (Gold Handle)

Tip (enlarged to show detail)	Cat. No.	Description	Total Length
	4004-56	Straight Carbon-Inlay Tips Fluted Handle	7" (18 cm)
	4004-57	Straight Carbon-Inlay Tips Serrated Handle	8 1/4" (21 cm)
	4004-59	Straight Carbon-Inlay Tips Serrated Handle	10" (25.4 cm)

Needle Pulling Tissue Forceps | Flat Handle

4004-37



SCANLAN®
DeBakey Needle Pulling Tissue Forceps
 Flat Handle (Gold Handle)

Tip (enlarged to show detail)	Cat. No.	Description	Total Length
	4004-37	2 mm Straight Carbon-Inlay with DeBakey Tips	7 1/2" (19 cm)

3789-07



Stainless Steel FORCEPS

SCANLAN®
Micro Forceps
 Bayonet Style | Round Handle

Tip (enlarged to show detail)	Cat. No.	Description	Total Length
	3789-07	1 mm Straight DIAMOND DUST™ Ring Tips	9" (23 cm)
	3789-08	0.8 mm Straight DIAMOND DUST™ Tips	9" (23 cm)
	3789-20		10" (25.4 cm)

3788-08



SCANLAN®
Micro Forceps
 Bayonet Style | Round Handle

Tip (enlarged to show detail)	Cat. No.	Description	Total Length
	3788-08	1 mm Straight DIAMOND DUST™ Ring Tips	9" (23 cm)
	3788-10	0.7 mm Straight DIAMOND DUST™ Tips	

Please Note...
 Each Scanlan instrument is individually handcrafted to provide the surgeon with the highest quality, longest-lasting, precision instrument possible.
 Reflecting this unique process, all stated dimensions are approximate.

Please check with your Scanlan Representative for Firm Sale status. Custom modifications available upon request.
 For a complete listing of models visit... www.scanlaninternational.com



Bayonet Style

Stainless Steel FORCEPS



3049-92



SCANLAN®

Tumor Grasping Forceps

Bayonet Style | Flat Handle

Tip (enlarged to show detail)	Cat. No.	Description	Total Length
	3049-90	3 mm Concave Serrated Tips	8 3/4" (22 cm)
	3049-92	5 mm Concave Serrated Tips	

4004-039



SCANLAN®

DeBakey Forcep

Bayonet Style | Flat Handle

Tip (enlarged to show detail)	Cat. No.	Description	Total Length
	4004-039	1.5 mm Straight DeBakey Tips	7 3/4" (19.5 cm)
	4004-043		9 1/2" (24 cm)

Please Note...

Each Scanlan instrument is individually handcrafted to provide the surgeon with the highest quality, longest-lasting, precision instrument possible. Reflecting this unique process, all stated dimensions are approximate.

Please check with your Scanlan Representative for Firm Sale status. Custom modifications available upon request.

For a complete listing of models visit... www.scanlaninternational.com

TITANIUM SPRING STYLE NEEDLE HOLDERS

LEGACY Needle Holders

LEGACY Round Handle 4.1
 LEGACY Flat Handle 4.5

Titanium Round Handle

Super-Micro Fine..... 4.8
 Micro Jaws..... 4.9
 Heavy Jaws..... 4.13

Titanium Flat Handle

Super-Micro Fine..... 4.14
 Micro Jaws..... 4.15
 Heavy Jaws..... 4.18

TITANIUM RING HANDLE

Micro Jaws 4.19
 Heavy Jaws 4.25

TITANIUM BAYONET STYLE

Micro Jaws 4.26

SPRING STYLE NEEDLE HOLDERS

Round Handle

Micro Jaws 4.27
 Heavy Jaws 4.34

Flat Handle

Micro Jaws 4.35

RING HANDLE NEEDLE HOLDERS

Micro Jaws 4.39
 Fine Jaws 4.41
 Heavy Jaws 4.45

BAYONET STYLE

Micro Jaws 4.47

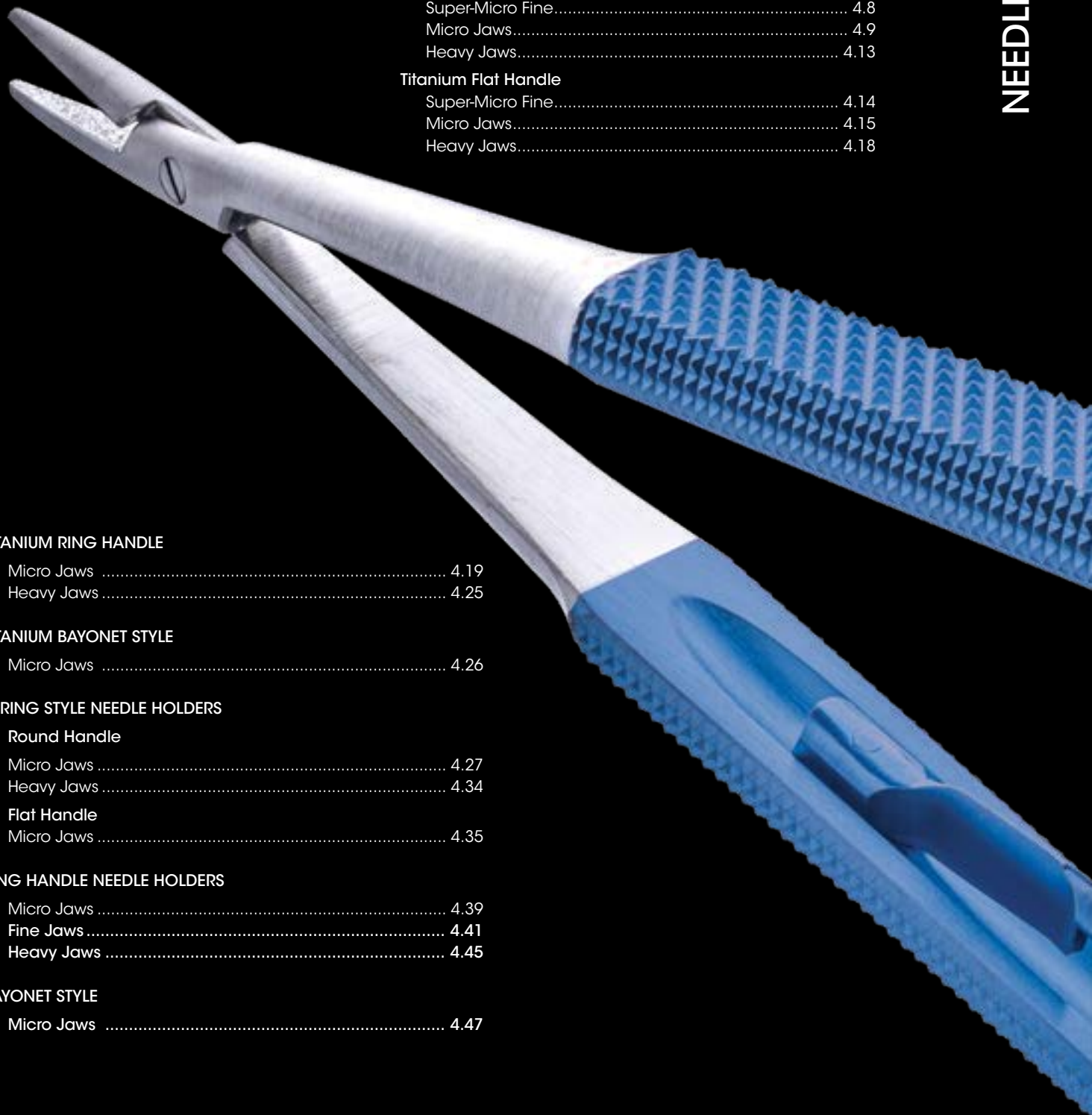

Needle Holder Modifications

Modification	Description
905	Cut down jaws/tips
905E	Cut down jaws/tips 0.4 mm
905TC	Cut down carbon-inlay jaws/tip
915	Gold plating
923	Satin finish instrument
924	Tension modification
928	Modify to left-handed instrument (ring handle)
928A	Modify to left-handed instrument (spring style)
929	Special etching
971	Lengthen instrument
973	Shorten instrument



3003-204

3003-204 with modifications **971**



3003-180

3003-180 with modifications **905**

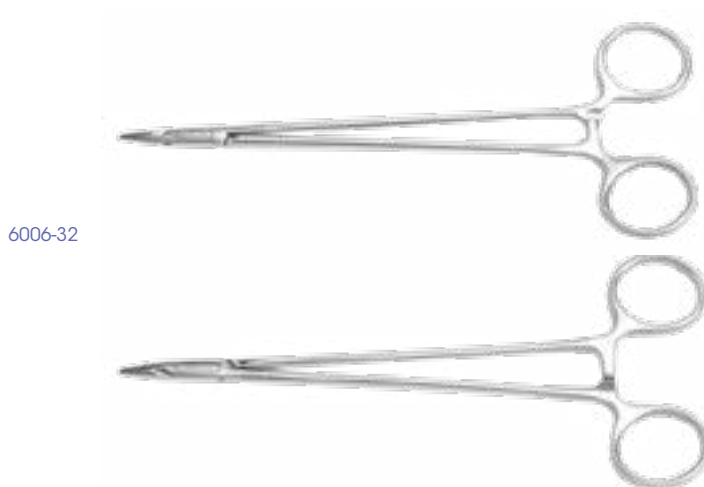

6006-32

6006-32 with modifications **928**

Please Note...

Each Scanlan instrument is individually handcrafted to provide the surgeon with the highest quality, longest-lasting, precision instrument possible. Reflecting this unique process, all stated dimensions are approximate.



Features of *LEGACY* Titanium Needle Holders

Titanium NEEDLE HOLDERS

Unique 10 mm Diameter and Extended Knurling

- Provides the titanium instruments with the optimized weight and balance.
- The extended knurling provides more surface area for the surgeon to grasp the instrument.

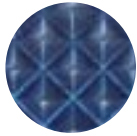

Perfect-Pyramid™

Provides a secure grasp.

Non-Magnetic

The properties of titanium prevent the needles from clinging to the instrument.

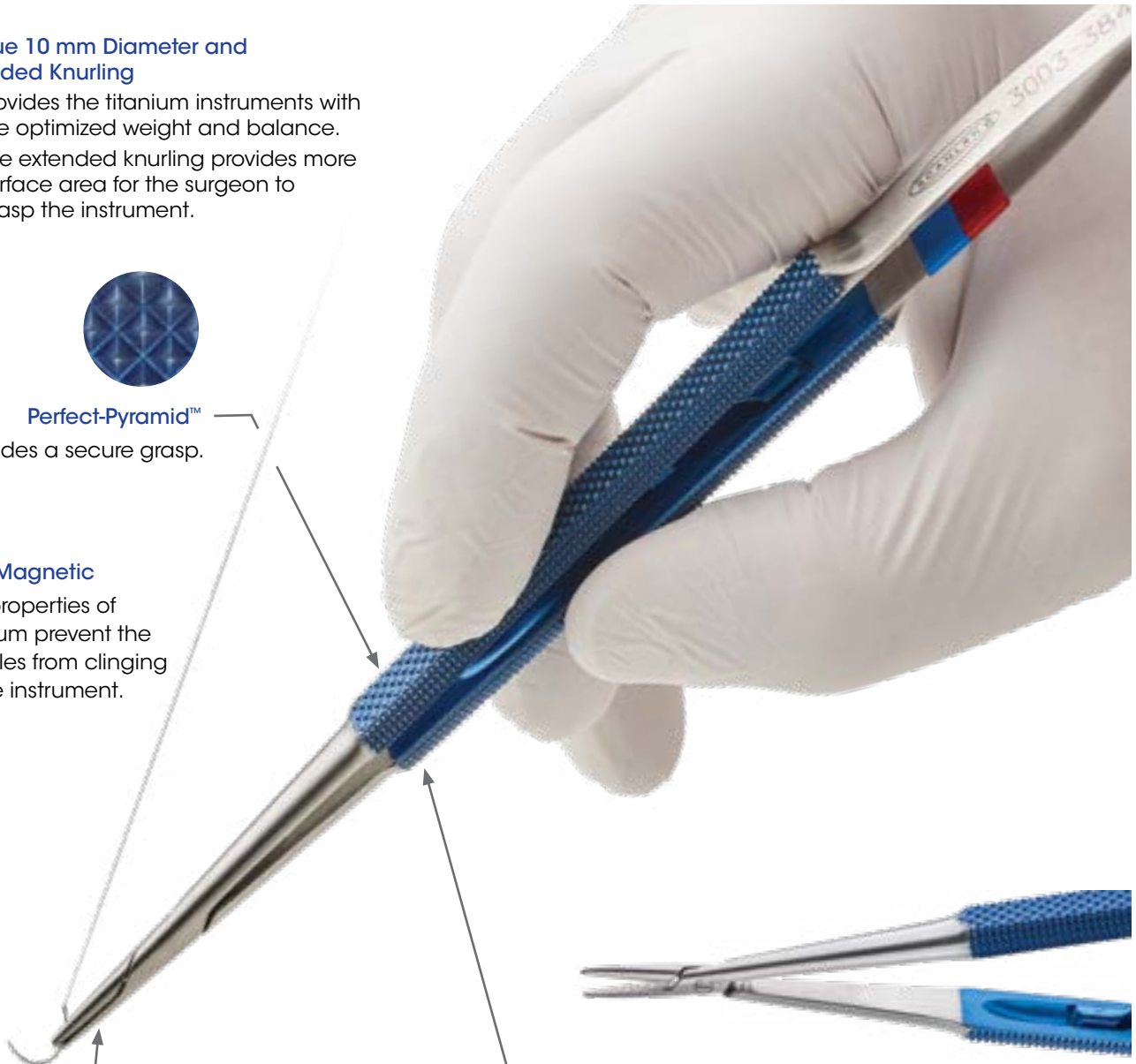

SCAN-II® Handle

Revolutionary design that features a flat surface for control with round knurled sides for a secured grip and the ability to roll the instrument during procedures.

Diamond-Dust™

Securely and delicately grips the needles to prevent slippage and any damage to the needle.



Round Handle

The original 10 mm round design provides the surgeon with a secure grip and the ability to roll the instrument during procedures.



3003-342

Instrument is shown approximate size



SCANLAN®

LEGACY Needle Holders

Round Handle | 10 mm Diameter, Extended Knurling

Jaws

(enlarged to show detail)

	Cat. No.	Description	Recommended Suture Size	Total Length
	3003-342			7" (18 cm)
	3003-344	Straight DIAMOND DUST™ Jaws Regular Box Lock With Ratchet	7-0 and Smaller	8" (20 cm)
	3003-346			9" (23 cm)
	3003-348			10" (25.4 cm)

3003-381



SCANLAN®

LEGACY Puskas™ Jacobson Micro Needle Holders

Round Handle | 8 mm Diameter, Extended Knurling

Jaws

(enlarged to show detail)

	Cat. No.	Description	Recommended Suture Size	Total Length
	3003-381	Straight DIAMOND DUST™ Jaws Regular Box Lock With Ratchet	7-0 and Smaller	8 1/4" (21 cm)
	3003-391			9 1/2" (24 cm)

Please Note...

Each Scanlan instrument is individually handcrafted to provide the surgeon with the highest quality, longest-lasting, precision instrument possible. Reflecting this unique process, all stated dimensions are approximate.

Spring Style | LEGACY | Round Handle | 5-0 Suture

3003-352

Instrument is shown approximate size

Titanium NEEDLE HOLDERS



SCANLAN®

LEGACY Needle Holders

Round Handle | 10 mm Diameter, Extended Knurling

Jaws

(enlarged to show detail)

	Cat. No.	Description	Recommended Suture Size	Total Length
	3003-352			7" (18 cm)
	3003-354	Straight DIAMOND DUST™ Jaws Streamline Box Lock With Ratchet	5-0 and Smaller	8" (20 cm)
	3003-356			9" (23 cm)
	3003-358			10" (25.4 cm)

3003-390



SCANLAN®

LEGACY Puskas™ Jacobson Micro Needle Holders

Round Handle | 8 mm Diameter, Extended Knurling

Jaws

(enlarged to show detail)

	Cat. No.	Description	Recommended Suture Size	Total Length
	3003-390	Straight DIAMOND DUST™ Jaws Streamline Box Lock With Ratchet	5-0 and Smaller	9" (23 cm)

Please check with your Scanlan Representative for Firm Sale status. Custom modifications available upon request.

For a complete listing of models visit... www.scanlaninternational.com





SCANLAN®

LEGACY Jacobson Micro Needle Holders

Round Handle | 10 mm Diameter, Extended Knurling

Jaws

(enlarged to show detail)

	Cat. No.	Description	Recommended Suture Size	Total Length
	3003-362			7" (18 cm)
	3003-364	Straight DIAMOND DUST™ Jaws	3-0 and Smaller	8" (20 cm)
	3003-366	Streamline Box Lock With Ratchet		9" (23 cm)
	3003-368			10" (25.4 cm)

Please Note...

Each Scanlan instrument is individually handcrafted to provide the surgeon with the highest quality, longest-lasting, precision instrument possible. Reflecting this unique process, all stated dimensions are approximate.

Spring Style | LEGACY | SCAN-II® Handle | 7-0 Suture

3003-374

Titanium NEEDLE HOLDERS



SCANLAN®

LEGACY Needle Holders

SCAN-II® Handle | 10 mm, Extended Knurling

Jaws

(enlarged to show detail)

	Cat. No.	Description	Recommended Suture Size	Total Length
	NEW 3003-372			7" (18 cm)
	NEW 3003-374	Straight DIAMOND DUST™ Jaws	7-0 and Smaller	8" (20 cm)
	NEW 3003-376	Regular Box Lock With Ratchet		9" (23 cm)
	NEW 3003-378			10" (25.4 cm)

Please check with your Scanlan Representative for Firm Sale status. Custom modifications available upon request.

For a complete listing of models visit... www.scanlaninternational.com





SCANLAN®
LEGACY Needle Holders
 SCAN-II® Handle | 10 mm, Extended Knurling

Jaws <small>(enlarged to show detail)</small>	Cat. No.	Description	Recommended Suture Size	Total Length
	NEW 3003-382			7" (18 cm)
	NEW 3003-384	Straight DIAMOND DUST™ Jaws	5-0 and Smaller	8" (20 cm)
	NEW 3003-386	Streamline Box Lock With Ratchet		9" (23 cm)
	NEW 3003-388			10" (25.4 cm)

Please Note...

Each Scanlan instrument is individually handcrafted to provide the surgeon with the highest quality, longest-lasting, precision instrument possible. Reflecting this unique process, all stated dimensions are approximate.

Spring Style | LEGACY | SCAN-II® Handle | 3-0 Suture

3003-334

Titanium NEEDLE HOLDERS



SCANLAN®
LEGACY Needle Holders
 SCAN-II® Handle | 10 mm, Extended Knurling

Jaws (enlarged to show detail)	Cat. No.	Description	Recommended Suture Size	Total Length
	NEW 3003-332	Straight DIAMOND DUST™ Jaws Streamline Box Lock With Ratchet	3-0 and Smaller	7" (18 cm)
	NEW 3003-334			8" (20 cm)
	NEW 3003-336			9" (23 cm)
	NEW 3003-338			10" (25.4 cm)

Please check with your Scanlan Representative for Firm Sale status. Custom modifications available upon request.
 For a complete listing of models visit... www.scanlaninternational.com



3303-646

Instrument is shown approximate size



SCANLAN®

Super-Micro Fine Needle Holders

Round Handle

Jaws

(enlarged to show detail)

	Cat. No.	Description	Recommended Suture Size	Total Length
	NEW 3303-646	Curved 0.3 mm DIAMOND DUST™ Jaws	9-0 and Smaller	5" (12.7 cm)
	3303-667	Regular Box Lock Without Ratchet		7 1/4" (18.5 cm)

3303-664



SCANLAN®

Super-Micro Fine Needle Holders

Round Handle

Jaws

(enlarged to show detail)

	Cat. No.	Description	Recommended Suture Size	Total Length
	NEW 3303-664	Straight 0.3 mm DIAMOND DUST™ Jaws	9-0 and Smaller	7 1/4" (18.5 cm)
		Regular Box Lock Without Ratchet		

Please Note...

Each Scanlan instrument is individually handcrafted to provide the surgeon with the highest quality, longest-lasting, precision instrument possible. Reflecting this unique process, all stated dimensions are approximate.

Spring Style | Round Handle | 8-0 Suture

3003-177-3

Titanium NEEDLE HOLDERS



SCANLAN®
Jacobson Micro Needle Holders
 Round Handle

Jaws
 (enlarged to show detail)

	Cat. No.	Description	Recommended Suture Size	Total Length
	3003-177-3	0.3 mm Curved Tapered DIAMOND DUST™ Jaws Regular Box Lock Without Ratchet	8-0 and Smaller	7 1/4" (18.5 cm)
	3003-177-4	0.4 mm Curved DIAMOND DUST™ Jaws Regular Box Lock Without Ratchet		

Please check with your Scanlan Representative for Firm Sale status. Custom modifications available upon request.
 For a complete listing of models visit... www.scanlaninternational.com















SCANLAN®

Jacobson Micro Needle Holders

Round Handle

Jaws

(enlarged to show detail)

	Cat. No.	Description	Recommended Suture Size	Total Length
	3003-171	Straight DIAMOND DUST™ Jaws Regular Box Lock With Ratchet	7-0 and Smaller	7 1/4" (18.5 cm)
	3003-173	Straight DIAMOND DUST™ Jaws Regular Box Lock Without Ratchet		
	3003-175	Curved DIAMOND DUST™ Jaws Regular Box Lock With Ratchet		
	3003-177	Curved DIAMOND DUST™ Jaws Regular Box Lock Without Ratchet		
	3003-181	Straight DIAMOND DUST™ Jaws Regular Box Lock With Ratchet		8" (20 cm)
	3003-183	Straight DIAMOND DUST™ Jaws Regular Box Lock Without Ratchet		
	3003-185	Curved DIAMOND DUST™ Jaws Regular Box Lock With Ratchet		
	3003-187	Curved DIAMOND DUST™ Jaws Regular Box Lock Without Ratchet		
	3003-191	Straight DIAMOND DUST™ Jaws Regular Box Lock With Ratchet		9" (23 cm)
	3003-193	Straight DIAMOND DUST™ Jaws Regular Box Lock Without Ratchet		
	3003-195	Curved DIAMOND DUST™ Jaws Regular Box Lock With Ratchet		

Spring Style | Round Handle | 5-0 Suture

3003-93











Instrument is shown approximate size



Titanium NEEDLE HOLDERS

SCANLAN®
Castroviejo Micro Needle Holders
 Round Handle

Jaws
 (enlarged to show detail)

	Cat. No.	Description	Recommended Suture Size	Total Length
	3003-90	Straight DIAMOND DUST™ Jaws Streamline Box Lock Without Ratchet	5-0 and Smaller	4 3/4" (12 cm)
	3003-90A	Straight DIAMOND DUST™ Jaws Streamline Box Lock With Ratchet		
	3003-91	Curved DIAMOND DUST™ Jaws Streamline Box Lock Without Ratchet		
	3003-91A	Curved DIAMOND DUST™ Jaws Streamline Box Lock With Ratchet		
	3003-93	Straight DIAMOND DUST™ Jaws Streamline Box Lock Without Ratchet		6" (15 cm)
	3003-93A	Straight DIAMOND DUST™ Jaws Streamline Box Lock With Ratchet		
	3003-94	Curved DIAMOND DUST™ Jaws Streamline Box Lock Without Ratchet		
	3003-94A	Curved DIAMOND DUST™ Jaws Streamline Box Lock With Ratchet		
	3003-94-4	Curved 0.4 mm DIAMOND DUST™ Jaws Streamline Box Lock Without Ratchet		
				

Please Note...
 Each Scanlan instrument is individually handcrafted to provide the surgeon with the highest quality, longest-lasting, precision instrument possible.
 Reflecting this unique process, all stated dimensions are approximate.

Please check with your Scanlan Representative for Firm Sale status. Custom modifications available upon request.
 For a complete listing of models visit... www.scanlaninternational.com





SCANLAN®

Jacobson Needle Holders

Round Handle

Jaws

(enlarged to show detail)

	Cat. No.	Description	Recommended Suture Size	Total Length
	3003-170	Straight DIAMOND DUST™ Jaws Streamline Box Lock With Ratchet	5-0 and Smaller	7 1/4" (18.5 cm)
	3003-172	Straight DIAMOND DUST™ Jaws Streamline Box Lock Without Ratchet		
	3003-174	Curved DIAMOND DUST™ Jaws Streamline Box Lock With Ratchet		
	3003-180	Straight DIAMOND DUST™ Jaws Streamline Box Lock With Ratchet		8" (20 cm)
	3003-182	Straight DIAMOND DUST™ Jaws Streamline Box Lock Without Ratchet		
	3003-184	Curved DIAMOND DUST™ Jaws Streamline Box Lock With Ratchet		
	3003-190	Straight DIAMOND DUST™ Jaws Streamline Box Lock With Ratchet		9" (23 cm)
	3003-200	Straight DIAMOND DUST™ Jaws Streamline Box Lock With Ratchet		10" (25.4 cm)
	3003-202	Straight DIAMOND DUST™ Jaws Streamline Box Lock Without Ratchet		
	3003-204	Curved DIAMOND DUST™ Jaws Streamline Box Lock With Ratchet		
	3003-200-12	Straight DIAMOND DUST™ Jaws Streamline Box Lock With Ratchet	12" (30.5 cm)	

Spring Style | Round Handle | 2-0 Suture

3003-530



Titanium NEEDLE HOLDERS

SCANLAN®
Jacobson Needle Holders
 For Large Needles | Round Handle

Jaws
 (enlarged to show detail)

	Cat. No.	Description	Recommended Suture Size	Total Length
	3003-510			7 1/2" (19 cm)
	3003-530	Straight DIAMOND DUST™ Jaws Streamline Box Lock With Ratchet	2-0 and Smaller	9" (23 cm)
	3003-540			10" (25.4 cm)
	NEW 3003-540-12			12" (30.5 cm)

Please Note...
 Each Scanlan instrument is individually handcrafted to provide the surgeon with the highest quality, longest-lasting, precision instrument possible.
 Reflecting this unique process, all stated dimensions are approximate.

Please check with your Scanlan Representative for Firm Sale status. Custom modifications available upon request.
 For a complete listing of models visit... www.scanlaninternational.com



3303-603

Instrument is shown approximate size



3303-622



SCANLAN®

Super-Micro Fine Needle Holders

Round Handle

Jaws

(enlarged to show detail)

	Cat. No.	Description	Recommended Suture Size	Total Length
	3303-603	Straight 0.3 mm DIAMOND DUST™ Jaws	9-0 and Smaller	5" (12.7 cm)
	NEW 3303-622	Regular Box Lock Without Ratchet		7 1/4" (18.5 cm)

Please Note...

Each Scanlan instrument is individually handcrafted to provide the surgeon with the highest quality, longest-lasting, precision instrument possible. Reflecting this unique process, all stated dimensions are approximate.

3003-225



Titanium NEEDLE HOLDERS

SCANLAN®

Jacobson Micro Needle Holders

Flat Handle

Jaws

(enlarged to show detail)

	Cat. No.	Description	Recommended Suture Size	Total Length
	3003-207	Straight DIAMOND DUST™ Jaws Regular Box Lock With Ratchet	7-0 and Smaller	5 3/4" (14.5 cm)
	3003-225	Straight DIAMOND DUST™ Jaws Regular Box Lock With Ratchet		7 1/4" (18.5 cm)
	3003-227	Straight DIAMOND DUST™ Jaws Regular Box Lock Without Ratchet		8" (20 cm)
	3003-229	Curved DIAMOND DUST™ Jaws Regular Box Lock With Ratchet		
	3003-261	Straight DIAMOND DUST™ Jaws Regular Box Lock With Ratchet		
	3003-263	Straight DIAMOND DUST™ Jaws Regular Box Lock Without Ratchet		
	3003-265	Curved DIAMOND DUST™ Jaws Regular Box Lock With Ratchet		

Please check with your Scanlan Representative for Firm Sale status. Custom modifications available upon request.

For a complete listing of models visit... www.scanlaninternational.com









SCANLAN®

Jacobson Micro Needle Holders

Flat Handle

Jaws

(enlarged to show detail)

	Cat. No.	Description	Recommended Suture Size	Total Length
	3003-235	Straight DIAMOND DUST™ Jaws Regular Box Lock With Ratchet	7-0 and Smaller	8 1/4" (21 cm)
	3003-237	Straight DIAMOND DUST™ Jaws Regular Box Lock Without Ratchet		
	3003-239	Curved DIAMOND DUST™ Jaws Regular Box Lock With Ratchet		
	3003-243	Straight DIAMOND DUST™ Jaws Regular Box Lock With Ratchet		9 1/2" (24 cm)

Please Note...

Each Scanlan instrument is individually handcrafted to provide the surgeon with the highest quality, longest-lasting, precision instrument possible. Reflecting this unique process, all stated dimensions are approximate.

Spring Style | Flat Handle | 5-0 Suture

3003-234-1



Titanium NEEDLE HOLDERS





SCANLAN®
Jacobson Micro Needle Holders
 Flat Handle

Jaws <small>(enlarged to show detail)</small>	Cat. No.	Description	Recommended Suture Size	Total Length
	3003-234-1	Straight Fine DIAMOND DUST™ Jaws Streamline Box Lock With Ratchet	5-0 and Smaller	8 1/2" (21.5 cm)

3003-224



SCANLAN®
Jacobson Micro Needle Holders
 Flat Handle

Jaws <small>(enlarged to show detail)</small>	Cat. No.	Description	Recommended Suture Size	Total Length
	3003-224	Straight DIAMOND DUST™ Jaws Streamline Box Lock With Ratchet	5-0 and Smaller	7 1/4" (18.5 cm)
	3003-226	Straight DIAMOND DUST™ Jaws Streamline Box Lock Without Ratchet		
	3003-234	Straight DIAMOND DUST™ Jaws Streamline Box Lock With Ratchet		
	3003-236	Straight DIAMOND DUST™ Jaws Streamline Box Lock Without Ratchet		8 1/2" (21.5 cm)
	3003-238	Curved DIAMOND DUST™ Jaws Streamline Box Lock With Ratchet		

Please check with your Scanlan Representative for Firm Sale status. Custom modifications available upon request.
 For a complete listing of models visit... www.scanlaninternational.com





SCANLAN®

Rendina Needle Holders

For Large Needles | Flat Handle Anniversary Knurl

Jaws

(enlarged to show detail)

	Cat. No.	Description	Recommended Suture Size	Total Length
	3003-550			7 1/2" (19 cm)
	3003-570	Straight DIAMOND DUST™ Jaws Streamline Box Lock With Ratchet	2-0 and Smaller	9" (23 cm)
	3003-580			10" (25.4 cm)

Please Note...

Each Scanlan instrument is individually handcrafted to provide the surgeon with the highest quality, longest-lasting, precision instrument possible. Reflecting this unique process, all stated dimensions are approximate.

3003-450

Instrument is shown approximate size

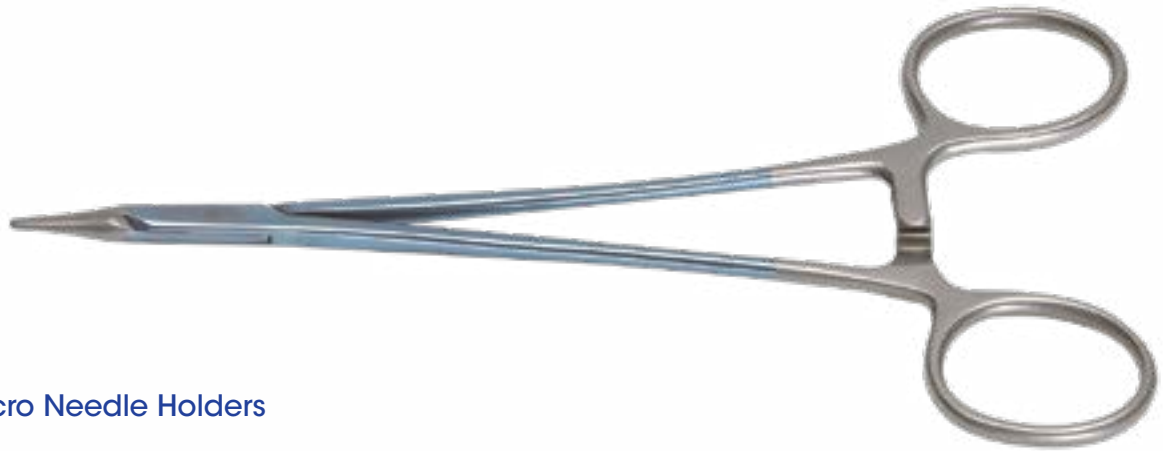

Titanium NEEDLE HOLDERS

SCANLAN®
Richards Micro Needle Holders
 Ring Handle

Jaws
 (enlarged to show detail)

	Cat. No.	Description	Recommended Suture Size	Total Length
	3003-450			6" (15 cm)
	3003-452	Straight Extra Fine DIAMOND DUST™ Jaws	6-0 and Smaller	6 3/4" (17 cm)
	3003-454			7 1/2" (19 cm)

Please check with your Scanlan Representative for Firm Sale status. Custom modifications available upon request.
 For a complete listing of models visit... www.scanlaninternational.com



3003-430

Instrument is shown approximate size



SCANLAN®
Ryder Needle Holders
 Ring Handle

Jaws
 (enlarged to show detail)

	Cat. No.	Description	Recommended Suture Size	Total Length
	3003-430			6" (15 cm)
	3003-432	Straight DIAMOND DUST™ Jaws	5-0 and Smaller	6 3/4" (17 cm)
	3003-434			7 1/2" (19 cm)

Please Note...

Each Scanlan instrument is individually handcrafted to provide the surgeon with the highest quality, longest-lasting, precision instrument possible. Reflecting this unique process, all stated dimensions are approximate.

3003-412



Titanium NEEDLE HOLDERS

SCANLAN®
DeBakey Micro Needle Holders
Ring Handle

Jaws (enlarged to show detail)	Cat. No.	Description	Recommended Suture Size	Total Length
	3003-412	Straight DIAMOND DUST™ Jaws	5-0 and Smaller	7 1/8" (18.1 cm)
	3003-414			8" (20 cm)
	3003-416			8 5/8" (21.9 cm)
	3003-418			10" (25.4 cm)

Please check with your Scanlan Representative for Firm Sale status. Custom modifications available upon request.
For a complete listing of models visit... www.scanlaninternational.com





SCANLAN®

Cardiovascular Needle Holders

Ring Handle

Jaws

(enlarged to show detail)

Jaws (enlarged to show detail)	Cat. No.	Description	Recommended Suture Size	Total Length
	3003-436	Straight Ryder Style DIAMOND DUST™ Jaws	5-0 and Smaller	7 1/8" (18.1 cm)
	3003-438			8" (20 cm)
	3003-440			8 5/8" (21.9 cm)
	3003-442			10" (25.4 cm)

Please Note...

Each Scanlan instrument is individually handcrafted to provide the surgeon with the highest quality, longest-lasting, precision instrument possible. Reflecting this unique process, all stated dimensions are approximate.

3003-422

Titanium NEEDLE HOLDERS



SCANLAN®
Microvascular Needle Holders
 Ring Handle

Jaws
 (enlarged to show detail)

	Cat. No.	Description	Recommended Suture Size	Total Length
	3003-422	Straight DIAMOND DUST™ Jaws	5-0 and Smaller	7 1/8" (18.1 cm)
	3003-424			8" (20 cm)
	3003-426			8 5/8" (21.9 cm)
	3003-428			10" (25.4 cm)



Please check with your Scanlan Representative for Firm Sale status. Custom modifications available upon request.
 For a complete listing of models visit... www.scanlaninternational.com





SCANLAN®
Micro Needle Holders
 Ring Handle

Jaws
 (enlarged to show detail)

	Cat. No.	Description	Recommended Suture Size	Total Length
	3003-462	Straight DIAMOND DUST™ Jaws	5-0 and Smaller	7 1/4" (18.5 cm)
	3003-466			8 3/4" (22 cm)
	3003-464	Curved DIAMOND DUST™ Jaws		7 1/4" (18.5 cm)

Please Note...

Each Scanlan instrument is individually handcrafted to provide the surgeon with the highest quality, longest-lasting, precision instrument possible. Reflecting this unique process, all stated dimensions are approximate.

3003-402

Instrument is shown approximate size



Titanium NEEDLE HOLDERS

SCANLAN®
Mayo-Hegar Needle Holders
 Ring Handle

Jaws

(enlarged to show detail)

	Cat. No.	Description	Recommended Suture Size	Total Length
	3003-402	Straight DIAMOND DUST™ Jaws	2-0 and Smaller	6 1/4" (16 cm)
	3003-404			7 1/8" (18.1 cm)
	3003-406			8" (20 cm)
	3003-408			8 5/8" (21.9 cm)

Please check with your Scanlan Representative for Firm Sale status. Custom modifications available upon request.
 For a complete listing of models visit... www.scanlaninternational.com



Bayonet Style | Round Handle | 5-0 Suture

Titanium NEEDLE HOLDERS

3789-11T



SCANLAN®
Micro Needle Holders
Round Handle





Jaws (enlarged to show detail)	Cat. No.	Description	Recommended Suture Size	Total Length
	3789-11T	Straight DIAMOND DUST™ Jaws Regular Box Lock With Ratchet	5-0 and Smaller	9 1/2" (24 cm)

Bayonet Style | Flat Handle | 6-0 Suture

3003-866



SCANLAN®
Micro Needle Holders
Flat Handle

Jaws (enlarged to show detail)	Cat. No.	Description	Recommended Suture Size	Total Length
	3003-866	Straight DIAMOND DUST™ Jaws Streamline Box Lock With Ratchet	6-0 and Smaller	8 3/4" (22 cm)
	3003-868	Straight DIAMOND DUST™ Jaws Streamline Box Lock Without Ratchet		
	3003-870	Curved DIAMOND DUST™ Jaws Streamline Box Lock With Ratchet		
	3003-872	Curved DIAMOND DUST™ Jaws Streamline Box Lock Without Ratchet		

Spring Style | Round Handle | 8-0 Suture

6006-56-3

Instrument is shown approximate size



SCANLAN®
Castroviejo Micro Needle Holders
 Round Handle

Jaws (enlarged to show detail)	Cat. No.	Description	Recommended Suture Size	Total Length
	6006-56-3	Curved 0.3 mm Tapered DIAMOND DUST™ Jaws Regular Box Lock Without Ratchet	8-0 and Smaller	5 3/4" (14.5 cm)

Titanium NEEDLE HOLDERS

SCANLAN®
Spring Style | Round Handle | 7-0 Suture

6006-44

Instrument is shown approximate size



SCANLAN®
Castroviejo Micro Needle Holders
 Round Handle

Jaws (enlarged to show detail)	Cat. No.	Description	Recommended Suture Size	Total Length
	6006-44	Straight DIAMOND DUST™ Jaws Regular Box Lock With Ratchet	7-0 and Smaller	4 3/4" (12 cm)
	6006-45	Straight DIAMOND DUST™ Jaws Regular Box Lock Without Ratchet		
	6006-46	Curved DIAMOND DUST™ Jaws Regular Box Lock With Ratchet		
	6006-47	Curved DIAMOND DUST™ Jaws Regular Box Lock Without Ratchet		

Please Note...
 Each Scanlan instrument is individually handcrafted to provide the surgeon with the highest quality, longest-lasting, precision instrument possible.
 Reflecting this unique process, all stated dimensions are approximate.

Please check with your Scanlan Representative for Firm Sale status. Custom modifications available upon request.
 For a complete listing of models visit... www.scanlaninternational.com



6006-121







SCANLAN®
Jacobson Micro Needle Holders

Round Handle

Jaws

(enlarged to show detail)

	Cat. No.	Description	Recommended Suture Size	Total Length
	6006-121	Straight DIAMOND DUST™ Jaws Regular Box Lock With Ratchet	7-0 and Smaller	8 1/4" (21 cm)
	6006-123	Straight DIAMOND DUST™ Jaws Regular Box Lock Without Ratchet		
	6006-125	Curved DIAMOND DUST™ Jaws Regular Box Lock With Ratchet		
	6006-127	Curved DIAMOND DUST™ Jaws Regular Box Lock Without Ratchet		

Please Note...

Each Scanlan instrument is individually handcrafted to provide the surgeon with the highest quality, longest-lasting, precision instrument possible. Reflecting this unique process, all stated dimensions are approximate.

Spring Style | Round Handle | 7-0 Suture

6006-128



SCANLAN®

Jacobson Micro Needle Holders

Short Knurling | Round Handle

Jaws (enlarged to show detail)	Cat. No.	Description	Recommended Suture Size	Total Length
	6006-128	Straight DIAMOND DUST™ Jaws Regular Box Lock With Ratchet	7-0 and Smaller	9" (23 cm)
	6006-130	Straight DIAMOND DUST™ Jaws Regular Box Lock Without Ratchet		
	6006-132	Curved DIAMOND DUST™ Jaws Regular Box Lock With Ratchet		

6006-129



SCANLAN®

Jacobson Micro Needle Holders

Round Handle

Jaws (enlarged to show detail)	Cat. No.	Description	Recommended Suture Size	Total Length
	6006-129	Straight DIAMOND DUST™ Jaws Regular Box Lock With Ratchet	7-0 and Smaller	9" (23 cm)
	6006-131	Straight DIAMOND DUST™ Jaws Regular Box Lock Without Ratchet		
	6006-133	Curved DIAMOND DUST™ Jaws Regular Box Lock With Ratchet		

Please check with your Scanlan Representative for Firm Sale status. Custom modifications available upon request.
For a complete listing of models visit... www.scanlaninternational.com



6006-48

Instrument is shown approximate size





SCANLAN®

Glasser Micro Needle Holders

Inside Spring | Round Handle

Jaws

(enlarged to show detail)

	Cat. No.	Description	Recommended Suture Size	Total Length
	6006-48	Straight DIAMOND DUST™ Jaws Regular Box Lock With Ratchet	5-0 and Smaller	4 7/8" (12.4 cm)
	6006-139	Curved DIAMOND DUST™ Jaws Regular Box Lock With Ratchet		7" (18 cm)

Please Note...

Each Scanlan instrument is individually handcrafted to provide the surgeon with the highest quality, longest-lasting, precision instrument possible. Reflecting this unique process, all stated dimensions are approximate.

Spring Style | Round Handle | 5-0 Suture

6006-50

Instrument is shown approximate size



Stainless Steel NEEDLE HOLDERS





SCANLAN®

Castroviejo Micro Needle Holders

Round Handle

Jaws

(enlarged to show detail)

	Cat. No.	Description	Recommended Suture Size	Total Length
	6006-50	Straight DIAMOND DUST™ Jaws Regular Box Lock With Ratchet	5-0 and Smaller	5 3/4" (14.5 cm)
	6006-52	Straight DIAMOND DUST™ Jaws Regular Box Lock Without Ratchet		
	6006-54	Curved DIAMOND DUST™ Jaws Regular Box Lock With Ratchet		
	6006-56	Curved DIAMOND DUST™ Jaws Regular Box Lock Without Ratchet		

Please check with your Scanlan Representative for Firm Sale status. Custom modifications available upon request.

For a complete listing of models visit... www.scanlaninternational.com



6006-59

Instrument is shown approximate size







SCANLAN®
Jacobson Micro Needle Holders

Round Handle

Jaws

(enlarged to show detail)

	Cat. No.	Description	Recommended Suture Size	Total Length
	6006-59	Straight DIAMOND DUST™ Jaws Regular Box Lock With Ratchet	5-0 and Smaller	6 1/4" (16 cm)
	6006-61	Straight DIAMOND DUST™ Jaws Regular Box Lock Without Ratchet		
	6006-63	Curved DIAMOND DUST™ Jaws Regular Box Lock With Ratchet		
	6006-65	Curved DIAMOND DUST™ Jaws Regular Box Lock Without Ratchet		

Please Note...





Each Scanlan instrument is individually handcrafted to provide the surgeon with the highest quality, longest-lasting, precision instrument possible. Reflecting this unique process, all stated dimensions are approximate.

Spring Style | Round Handle | 5-0 Suture

6006-82





SCANLAN®
Jacobson Micro Needle Holders
 Round Handle

Jaws (enlarged to show detail)	Cat. No.	Description	Recommended Suture Size	Total Length
	6006-82	Straight DIAMOND DUST™ Jaws Regular Box Lock With Ratchet	5-0 and Smaller	7 1/4" (18.5 cm)
	6006-84	Straight DIAMOND DUST™ Jaws Regular Box Lock Without Ratchet		
	6006-86	Curved DIAMOND DUST™ Jaws Regular Box Lock With Ratchet		
	6006-88	Curved DIAMOND DUST™ Jaws Regular Box Lock Without Ratchet		

6006-120



SCANLAN®
Jacobson Micro Needle Holders
 Round Handle

Jaws (enlarged to show detail)	Cat. No.	Description	Recommended Suture Size	Total Length
	6006-120	Straight DIAMOND DUST™ Jaws Streamline Box Lock With Ratchet	5-0 and Smaller	8 1/4" (21 cm)
	6006-122	Straight DIAMOND DUST™ Jaws Streamline Box Lock Without Ratchet		
	6006-124	Curved DIAMOND DUST™ Jaws Streamline Box Lock With Ratchet		

Please check with your Scanlan Representative for Firm Sale status. Custom modifications available upon request.
 For a complete listing of models visit... www.scanlaninternational.com



6006-330







SCANLAN®

Jacobson Heavy Jaw Needle Holders

For Large Needles | Round Handle

Jaws

(enlarged to show detail)

	Cat. No.	Description	Recommended Suture Size	Total Length
	6006-310	Straight DIAMOND DUST™ Jaws Regular Box Lock With Ratchet	2-0 and Smaller	7 1/2" (19 cm)
	6006-330			9" (23 cm)
	6006-340			10" (25.4 cm)
	6006-334	Curved DIAMOND DUST™ Jaws Regular Box Lock With Ratchet		9" (23 cm)

Please Note...

Each Scanlan instrument is individually handcrafted to provide the surgeon with the highest quality, longest-lasting, precision instrument possible. Reflecting this unique process, all stated dimensions are approximate.

Spring Style | Flat Handle | 7-0 Suture

6006-70

Instrument is shown approximate size



SCANLAN®

Jacobson Micro Needle Holders

Flat Handle

Jaws

(enlarged to show detail)

	Cat. No.	Description	Recommended Suture Size	Total Length
	6006-70	Straight DIAMOND DUST™ Jaws Regular Box Lock With Ratchet	7-0 and Smaller	6 3/4" (17 cm)
	6006-72	Straight DIAMOND DUST™ Jaws Regular Box Lock Without Ratchet		

Stainless Steel NEEDLE HOLDERS

Please check with your Scanlan Representative for Firm Sale status. Custom modifications available upon request.

For a complete listing of models visit... www.scanlaninternational.com



6006-58

Instrument is shown approximate size

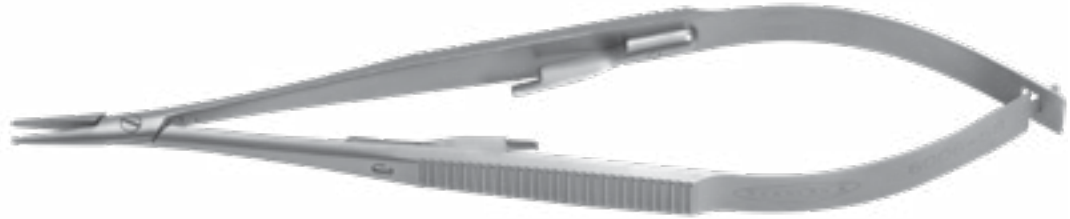



SCANLAN®

Castroviejo Micro Needle Holders

Flat Handle

Jaws

(enlarged to show detail)

	Cat. No.	Description	Recommended Suture Size	Total Length
	6006-58	Straight DIAMOND DUST™ Jaws Regular Box Lock With Ratchet	5-0 and Smaller	5 1/2" (14 cm)
	6006-62	Curved DIAMOND DUST™ Jaws Regular Box Lock With Ratchet		

6006-90





SCANLAN®

Jacobson Micro Needle Holders

Flat Handle

Jaws

(enlarged to show detail)

	Cat. No.	Description	Recommended Suture Size	Total Length
	6006-90	Straight DIAMOND DUST™ Jaws Regular Box Lock With Ratchet	5-0 and Smaller	7 1/4" (18.5 cm)
	6006-92	Straight DIAMOND DUST™ Jaws Regular Box Lock Without Ratchet		
	6006-94	Curved DIAMOND DUST™ Jaws Regular Box Lock With Ratchet		

Please Note...

Each Scanlan instrument is individually handcrafted to provide the surgeon with the highest quality, longest-lasting, precision instrument possible. Reflecting this unique process, all stated dimensions are approximate.

Spring Style | Flat Handle | 5-0 Suture

6006-108

Stainless Steel NEEDLE HOLDERS

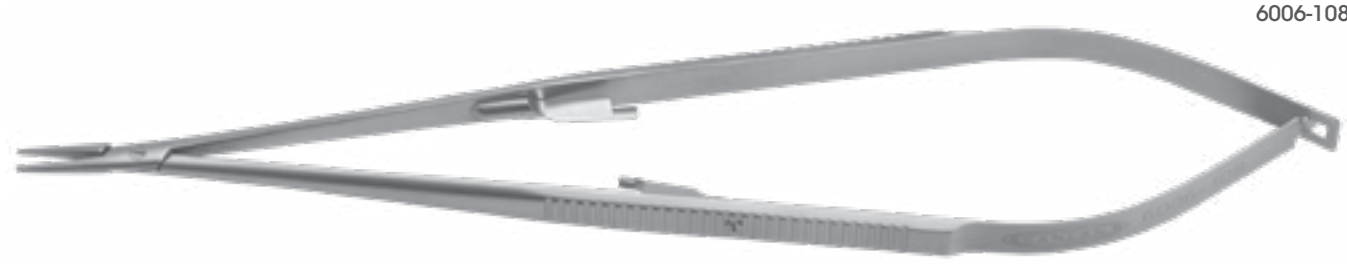



SCANLAN®

Jacobson Micro Needle Holders

Flat Handle

Jaws

(enlarged to show detail)

	Cat. No.	Description	Recommended Suture Size	Total Length
	6006-108	Straight DIAMOND DUST™ Jaws	5-0 and Smaller	8 1/4" (21 cm)
	6006-158	Regular Box Lock With Ratchet		9 1/2" (24 cm)
	6006-110	Straight DIAMOND DUST™ Jaws		8 1/4" (21 cm)
	6006-159	Regular Box Lock Without Ratchet		9 1/2" (24 cm)
	6006-112	Curved DIAMOND DUST™ Jaws		8 1/4" (21 cm)
	6006-160	Regular Box Lock With Ratchet		9 1/2" (24 cm)

Please check with your Scanlan Representative for Firm Sale status. Custom modifications available upon request.

For a complete listing of models visit... www.scanlaninternational.com



6006-100





SCANLAN®

Jacobson Micro Needle Holders

Flat Knurled Handle

Jaws

(enlarged to show detail)

	Cat. No.	Description	Recommended Suture Size	Total Length
	6006-170		5-0 and Smaller	7 1/4" (18.5 cm)
	6006-100	Straight DIAMOND DUST™ Jaws Regular Box Lock With Ratchet		8" (20 cm)
	6006-174			9" (23 cm)
	6006-102	Straight DIAMOND DUST™ Jaws Regular Box Lock Without Ratchet		8" (20 cm)
	6006-104	Curved DIAMOND DUST™ Jaws Regular Box Lock With Ratchet		8" (20 cm)

Please Note...

Each Scanlan instrument is individually handcrafted to provide the surgeon with the highest quality, longest-lasting, precision instrument possible. Reflecting this unique process, all stated dimensions are approximate.

4157-77

Instrument is shown approximate size



SCANLAN®
Kaye Needle Holders / Scissors
Ring Handle

Jaws
(enlarged to show detail)

	Cat. No.	Description	Recommended Suture Size	Total Length
	4157-77	Straight DIAMOND DUST™ Jaws	5-0 and Smaller	4 3/4" (12 cm)

4155-07

Instrument is shown approximate size



SCANLAN®
Webster Micro Needle Holders
Ring Handle

Jaws
(enlarged to show detail)

	Cat. No.	Description	Recommended Suture Size	Total Length
	4155-06	Straight Delicate DIAMOND DUST™ Jaws	5-0 and Smaller	5 1/8" (13 cm)
	4155-07	Straight Delicate DIAMOND DUST™ Jaws Offset Bows		

Please check with your Scanlan Representative for Firm Sale status. Custom modifications available upon request.
For a complete listing of models visit... www.scanlaninternational.com





SCANLAN®

Jacobson Micro Needle Holders

Ring Handle

Jaws

(enlarged to show detail)

	Cat. No.	Description	Recommended Suture Size	Total Length
	6006-148	Straight DIAMOND DUST™ Jaws With Ratchet	5-0 and Smaller	7 1/4" (18.5 cm)
	6006-152			9" (23 cm)

Please Note...

Each Scanlan instrument is individually handcrafted to provide the surgeon with the highest quality, longest-lasting, precision instrument possible. Reflecting this unique process, all stated dimensions are approximate.

6006-04

Stainless Steel NEEDLE HOLDERS

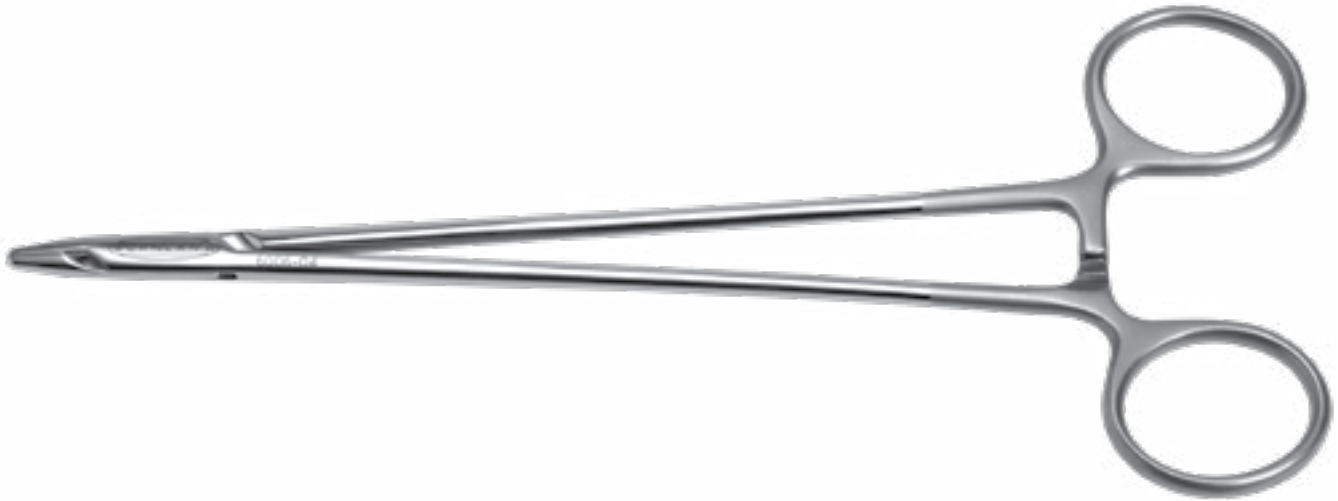

SCANLAN®
Dennis Delicate Needle Holders
 Ring Handle

Jaws <small>(enlarged to show detail)</small>	Cat. No.	Description	Recommended Suture Size	Total Length
	6006-04	Straight DIAMOND DUST™ Jaws	5-0 and Smaller	7" (18 cm)



Please check with your Scanlan Representative for Firm Sale status. Custom modifications available upon request.
 For a complete listing of models visit... www.scanlaninternational.com





SCANLAN®
Micro Needle Holders
 Ryder-Style | Ring Handle

Jaws
 (enlarged to show detail)

	Cat. No.	Description	Recommended Suture Size	Total Length
	6006-02	Straight 1.5 mm DIAMOND DUST™ Jaws	5-0 and Smaller	6 1/4" (16 cm)
	6006-29	Straight 1.2 mm DIAMOND DUST™ Jaws		6 1/4" (16 cm)
	6006-33			7 1/4" (18.5 cm)
	6006-37			8 3/4" (22 cm)
	6006-41			10" (25.4 cm)

Please Note...

Each Scanlan instrument is individually handcrafted to provide the surgeon with the highest quality, longest-lasting, precision instrument possible. Reflecting this unique process, all stated dimensions are approximate.

6006-32



Stainless Steel NEEDLE HOLDERS

SCANLAN®
Micro Needle Holders
 Ring Handle

Jaws
 (enlarged to show detail)

	Cat. No.	Description	Recommended Suture Size	Total Length
	6006-20	Straight DIAMOND DUST™ Jaws	5-0 and Smaller	5" (12.7 cm)
	6006-24			5 3/4" (14.5 cm)
	6006-28			6 1/4" (16 cm)
	6006-32			7 1/4" (18.5 cm)
	6006-36			8 3/4" (22 cm)
	6006-40			10" (25.4 cm)

Please check with your Scanlan Representative for Firm Sale status. Custom modifications available upon request.
 For a complete listing of models visit... www.scanlaninternational.com



6006-08

Instrument is shown approximate size



SCANLAN®
Fell Needle Holders

Ring Handle

Jaws
(enlarged to show detail)

	Cat. No.	Description	Recommended Suture Size	Total Length
	6006-08	2 mm Straight Carbon-Inlay Jaws Gold Handle	3-0 and Smaller	6" (15 cm)
	6006-10			7" (18 cm)
	6006-12			8" (20 cm)
	6006-14			8 1/2" (21.5 cm)
	6006-17			10 1/2" (27 cm)
	6006-19			11 3/4" (29.8 cm)

Please Note...

Each Scanlan instrument is individually handcrafted to provide the surgeon with the highest quality, longest-lasting, precision instrument possible. Reflecting this unique process, all stated dimensions are approximate.

6006-630



Stainless Steel NEEDLE HOLDERS

SCANLAN®
Heavy Jaw Needle Holders
 Ring Handle

Jaws
 (enlarged to show detail)

	Cat. No.	Description	Recommended Suture Size	Total Length
	6006-610			7 1/4" (18.5 cm)
	6006-620	Straight DIAMOND DUST™ Jaws	2-0 and Smaller	8 1/8" (20.1 cm)
	6006-630			9 1/8" (23.5 cm)

Please check with your Scanlan Representative for Firm Sale status. Custom modifications available upon request.
 For a complete listing of models visit... www.scanlaninternational.com



Ring Handle | 2-0 Suture

Stainless Steel NEEDLE HOLDERS

6006-16



SCANLAN®
Stratte Valve Needle Holders
 Ring Handle

Jaws <small>(enlarged to show detail)</small>	Cat. No.	Description	Recommended Suture Size	Total Length
	6006-15	Curved Carbon-Inlay Jaws Gold Handle	2-0 and Smaller	7 1/2" (19 cm)
	6006-16			10" (25.4 cm)

Ring Handle | #5 Wire

6006-05



SCANLAN®
Sternal Needle Holders
 Ring Handle

Jaws <small>(enlarged to show detail)</small>	Cat. No.	Description	Recommended Wire Size	Total Length
	6006-05	Straight Carbon-Inlay Jaws Gold Handle	#5 and Smaller	7" (18 cm)

Please Note...

Each Scanlan instrument is individually handcrafted to provide the surgeon with the highest quality, longest-lasting, precision instrument possible. Reflecting this unique process, all stated dimensions are approximate.

Please check with your Scanlan Representative for Firm Sale status. Custom modifications available upon request.

For a complete listing of models visit... www.scanlaninternational.com

Bayonet Style | Round Handle | 8-0 Suture

3789-14-3



SCANLAN®
Micro Needle Holders
 Round Handle

Jaws <small>(enlarged to show detail)</small>	Cat. No.	Description	Recommended Suture Size	Total Length
	3789-14-3	Curved Up 0.3 mm DIAMOND DUST™ Jaws Regular Box Lock Without Ratchet	8-0 and Smaller	9" (23 cm)

SCANLAN®

Bayonet Style | Round Handle | 7-0 Suture

3789-11



SCANLAN®
Micro Needle Holders
 Round Handle

Jaws <small>(enlarged to show detail)</small>	Cat. No.	Description	Recommended Suture Size	Total Length
	3789-11	Straight DIAMOND DUST™ Jaws Regular Box Lock With Ratchet	7-0 and Smaller	9" (23 cm)
	3789-13	Straight DIAMOND DUST™ Jaws Regular Box Lock Without Ratchet		
	3789-12	Curved Up DIAMOND DUST™ Jaws Regular Box Lock With Ratchet		
	3789-14	Curved Up DIAMOND DUST™ Jaws Regular Box Lock Without Ratchet		





Stainless Steel NEEDLE HOLDERS





SCANLAN®
Micro Needle Holders
 Flat Handle

Jaws
 (enlarged to show detail)

	Cat. No.	Description	Recommended Suture Size	Total Length
	3788-12	Straight DIAMOND DUST™ Jaws Regular Box Lock With Ratchet	7-0 and Smaller	9" (23 cm)
	3788-14	Straight DIAMOND DUST™ Jaws Regular Box Lock Without Ratchet		
	3788-13	Curved Up DIAMOND DUST™ Jaws Regular Box Lock With Ratchet		
	3788-15	Curved Up DIAMOND DUST™ Jaws Regular Box Lock Without Ratchet		

Please Note...

Each Scanlan instrument is individually handcrafted to provide the surgeon with the highest quality, longest-lasting, precision instrument possible. Reflecting this unique process, all stated dimensions are approximate.

Please check with your Scanlan Representative for Firm Sale status. Custom modifications available upon request.

For a complete listing of models visit... www.scanlaninternational.com

SPRING STYLE

Round Handle

Super-Micro Fine Blades	5.1
Nano Blades	5.2
Micro Fine Blades	5.3
Fine Blades	5.6

Flat Handle

Super-Micro Fine Blades	5.10
Nano Blades	5.11
Micro Fine Blades	5.13
Fine Blades	5.16

BAYONET STYLE

Round Handle

Micro Fine Blades	5.21
-------------------------	------

Flat Handle

Nano Blades	5.22
Micro Fine Blades	5.23
Fine Blades	5.24

RING HANDLE

Diethrich-Potts	5.25
Favaloro	5.27
Hegeman	5.28
DeBakey	5.29
Stevens Tenotomy	5.30
Lillehei-Potts	5.31
Meitzenbaum	5.33
Ragnell Dissecting	5.37
Mayo	5.38
Iris-Eye	5.41
Plastic-Jabaley	5.42
C.V.H. / Peck Joseph	5.43
Sternum Pediatric	5.44
Face Lift	5.44
Laine-Kindal	5.45
Dissecting	5.45
Thompson Valve	5.46
Flemma Mitral	5.46
Venous Valve (In Situ)	5.47

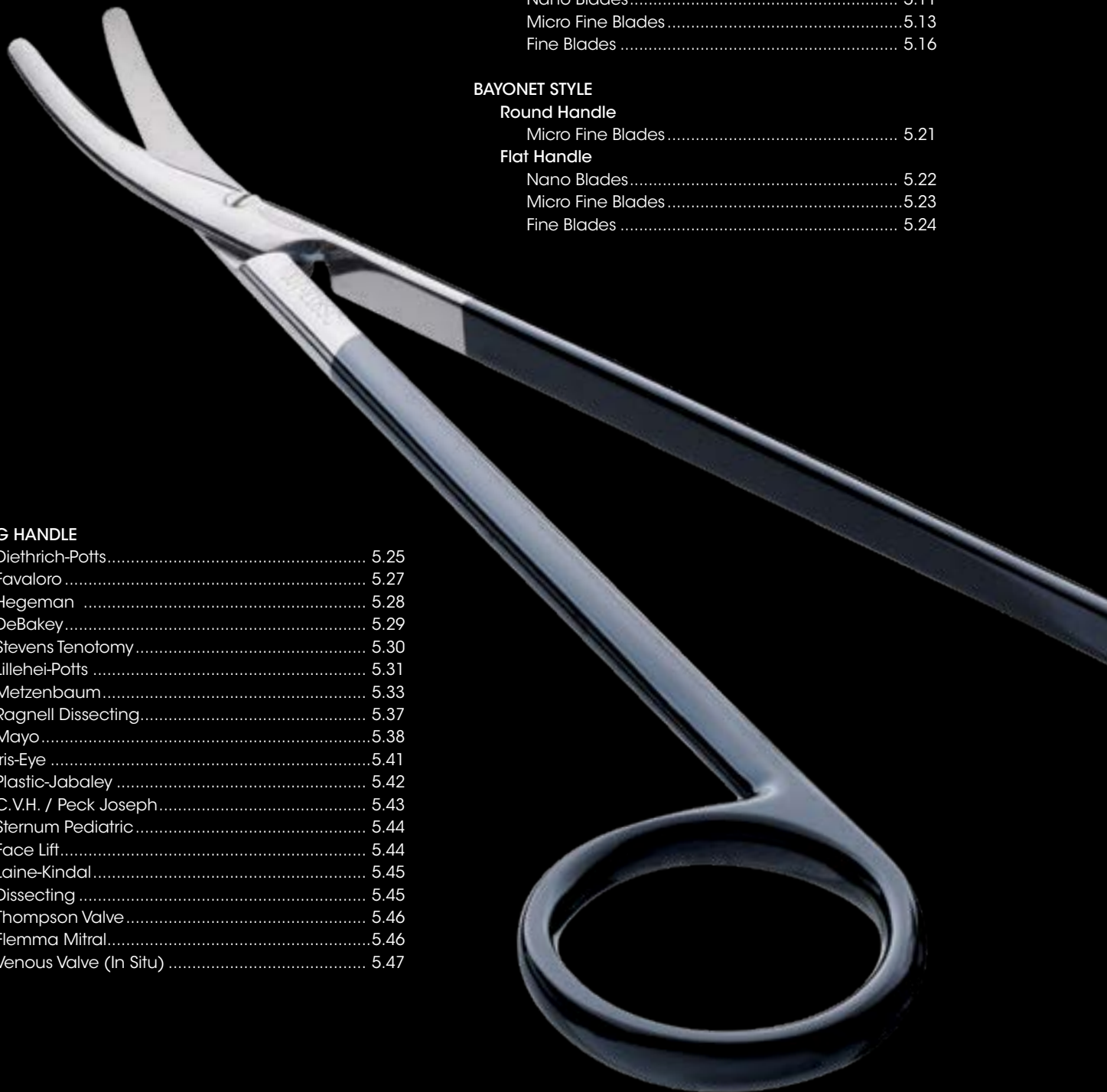

Modification	Description
905B	Cut down scissors blades
907A	Angled shanks on scissors - down
907C	Angled shanks on scissors - up
910	Tenotomy points scissors
910A	Tenotomy points ULTRA SHARP® / Super Cut™ scissors
911	Cut down shanks
912	Blunt tips of scissors
914	Serrations of blade (one)
918	Flatten tips (Ragnell style)
923	Satin finish instrument
929	Special etching

7007-446-8



7007-446-8 with modification 907A

7007-218



7007-218 with modification 910A

Spring Style Scissors with Angled Blades



Nano Blades, 7 mm
(7007-592)



Micro Fine Blades, 10 mm
(7007-492)



Fine Blades, 15 mm
(7007-462)

Ring Handle Scissors with Angled Blades



45° Angled Micro Blades, 10 mm
(7007-252-5SC)



45° Angled Fine Blades, 15 mm
(7007-252SC)

Please Note...

Each Scanlan instrument is individually handcrafted to provide the surgeon with the highest quality, longest-lasting, precision instrument possible. Reflecting this unique process, all stated dimensions are approximate.



Spring Style | Round Handle | Nano Blades

7007-768

SCISSORS



SCANLAN®

Premier™ Super-Micro Fine Jacobson Scissors

Round Handle | Straight Nano Blades

Instrument blades are shown approximate size

	Cat. No.	Description	Total Length
	7007-768	Straight Nano Blades	7 1/4" (18.5 cm)

7007-729

Instrument is shown approximate size



SCANLAN®

Premier™ Super-Micro Fine Jacobson Scissors

Round Handle | Curved Nano Blades

Instrument blades are shown approximate size

	Cat. No.	Description	Total Length
	NEW 7007-729	Curved Nano Blades	7 1/4" (18.5 cm)

Please Note... Each Scanlan instrument is individually handcrafted to provide the surgeon with the highest quality, longest-lasting, precision instrument possible. Reflecting this unique process, all stated dimensions are approximate.

Please check with your Scanlan Representative for Firm Sale status. Custom modifications available upon request. For a complete listing of models visit... www.scanlaninternational.com



7007-592

Instrument is shown approximate size



SCANLAN®

Premier™ Jacobson Micro Scissors

Round Handle | Angled Nano Blades

Instrument blades are shown approximate size

	Cat. No.	Description	Total Length
	7007-590	25° Angled Nano Blades	6 3/4" (17 cm)
	NEW 7007-590-8		8" (20 cm)
	7007-592	45° Angled Nano Blades	6 3/4" (17 cm)
	NEW 7007-592-8		8" (20 cm)
	7007-594	60° Angled Nano Blades	6 3/4" (17 cm)
	NEW 7007-594-8		8" (20 cm)
	7007-596	90° Angled Nano Blades	6 1/2" (16.5 cm)
	NEW 7007-596-8		8" (20 cm)
	7007-598	V-Neck 125° Angled Nano Blades	6 1/2" (16.5 cm)

Please Note...

Each Scanlan instrument is individually handcrafted to provide the surgeon with the highest quality, longest-lasting, precision instrument possible. Reflecting this unique process, all stated dimensions are approximate.

Spring Style | Round Handle | Micro Fine Blades

7007-421
Instrument is shown approximate size



SCISSORS

SCANLAN®

Premier™ Castroviejo Micro Scissors

Round Handle | Angled Micro Fine Blades

Instrument blades are shown approximate size

	Cat. No.	Description	Total Length
	7007-421	25° Angled Micro Fine Blades	4 1/4" (11 cm)
	7007-423	45° Angled Micro Fine Blades	
	7007-425	60° Angled Micro Fine Blades	
	7007-427	90° Angled Micro Fine Blades	4 1/8" (10.5 cm)
	7007-429	125° Angled Micro Fine Blades	

Please check with your Scanlan Representative for Firm Sale status. Custom modifications available upon request.

For a complete listing of models visit... www.scanlaninternational.com









SCANLAN®

Premier™ Jacobson Micro Scissors

Round Handle | Angled Micro Fine Blades

Instrument blades are shown approximate size

	Cat. No.	Description	Total Length
	7007-490	25° Angled Micro Fine Blades	6 3/4" (17 cm)
	7007-490-8		8" (20 cm)
	7007-492	45° Angled Micro Fine Blades	6 3/4" (17 cm)
	7007-492-8		8" (20 cm)
	7007-494	60° Angled Micro Fine Blades	6 3/4" (17 cm)
	7007-494-8		8" (20 cm)
	7007-496	90° Angled Micro Fine Blades	6 1/2" (16.5 cm)
	7007-496-8		8" (20 cm)
	7007-498	125° Angled Micro Fine Blades	6 1/2" (16.5 cm)

Please Note...

Each Scanlan instrument is individually handcrafted to provide the surgeon with the highest quality, longest-lasting, precision instrument possible. Reflecting this unique process, all stated dimensions are approximate.

Spring Style | Round Handle | Micro Fine Blades

7007-499

Instrument is shown approximate size

SCISSORS



SCANLAN®

Premier™ Jacobson Micro Scissors

Round Handle | V-Neck, 125° Angled Micro Fine Blades

Instrument blades are shown approximate size

	Cat. No.	Description	Total Length
	7007-499	V-Neck 125° Angled Micro Fine Blades	6 1/2" (16.5 cm)
	7007-499-8		8" (20 cm)

Please check with your Scanlan Representative for Firm Sale status. Custom modifications available upon request.

For a complete listing of models visit... www.scanlaninternational.com



7007-420

Instrument is shown approximate size







SCANLAN®

Premier™ Castroviejo Micro Scissors

Round Handle | Angled Fine Blades

Instrument blades are shown approximate size

	Cat. No.	Description	Total Length
	7007-420	25° Angled Fine Blades	4 1/2" (11.5 cm)
	7007-422	45° Angled Fine Blades	
	7007-424	60° Angled Fine Blades	
	7007-426	90° Angled Fine Blades	4 1/4" (11 cm)
	7007-428	125° Angled Fine Blades	

Please Note...

Each Scanlan instrument is individually handcrafted to provide the surgeon with the highest quality, longest-lasting, precision instrument possible. Reflecting this unique process, all stated dimensions are approximate.

Spring Style | Round Handle | Fine Blades

7007-106

Instrument is shown approximate size

SCISSORS



SCANLAN®

Castroviejo Micro Scissors

Round Handle | Fine Blade

Instrument blades are shown approximate size

	Cat. No.	Description	Total Length
	7007-104	Straight Fine Blades Sharp Tips	5 1/2" (14 cm)
	7007-105	Straight Fine Blades Blunt Tips	4 1/4" (11 cm)
	7007-106		5 1/2" (14 cm)
	7007-108	Curved Fine Blades Sharp Tips	5 1/2" (14 cm)
	7007-110	Curved Fine Blades Blunt Tips	

Please check with your Scanlan Representative for Firm Sale status. Custom modifications available upon request.

For a complete listing of models visit... www.scanlaninternational.com









SCANLAN®
Premier™ Jacobson Micro Scissors

Round Handle | Angled Fine Blades

Instrument blades are shown
approximate size

	Cat. No.	Description	Total Length
	7007-460	25° Angled Fine Blades	7" (18 cm)
	7007-462	45° Angled Fine Blades	
	7007-464	60° Angled Fine Blades	
	7007-466	90° Angled Fine Blades	6 1/2" (16.5 cm)
	7007-468	125° Angled Fine Blades	

Please Note...

Each Scanlan instrument is individually handcrafted to provide the surgeon with the highest quality, longest-lasting, precision instrument possible. Reflecting this unique process, all stated dimensions are approximate.

Spring Style | Round Handle | Fine Blades

7007-128

Instrument is shown approximate size

SCISSORS



SCANLAN®

Jacobson Micro Scissors

Round Handle | Fine Blade

Instrument blades are shown approximate size

	Cat. No.	Description	Total Length
	7007-128	Straight Fine Blades Sharp Tips	7" (18 cm)
	7007-132	Straight Fine Blades Blunt Tips	
	7007-130	Curved Fine Blades Sharp Tips	
	7007-134	Curved Fine Blades Blunt Tips	

Please check with your Scanlan Representative for Firm Sale status. Custom modifications available upon request.

For a complete listing of models visit... www.scanlaninternational.com



7007-712

Instrument is shown approximate size



SCANLAN®

Premier™ Super-Micro Fine Castroviejo Scissors

Flat Handle | Curved Nano Blades

Instrument blades are shown approximate size

	Cat. No.	Description	Total Length
	NEW 7007-712	Curved Nano Blades	5" (12.7 cm)

Please Note...

Each Scanlan instrument is individually handcrafted to provide the surgeon with the highest quality, longest-lasting, precision instrument possible. Reflecting this unique process, all stated dimensions are approximate.

Please check with your Scanlan Representative for Firm Sale status. Custom modifications available upon request.

For a complete listing of models visit... www.scanlaninternational.com

Spring Style | Flat Handle | Nano Blades

SCISSORS

7007-401
Instrument is shown approximate size



SCANLAN®

Premier™ Castroviejo Micro Scissors

Flat Handle | Nano Blades

Instrument blades are shown approximate size

	Cat. No.	Description	Total Length
	7007-401	Straight Sharp Nano Blades	4 1/8" (10.5 cm)
	7007-402	Curved Sharp Nano Blades	
	7007-403	25° Angled Nano Blades	
	7007-404	45° Angled Nano Blades	

7007-538
Instrument is shown approximate size



SCANLAN®

Premier™ Jacobson Micro Scissors

Flat Handle | Nano Blades

Instrument blades are shown approximate size

	Cat. No.	Description	Total Length
	7007-538	Straight Sharp Nano Blades	6" (15 cm)
	7007-539	Curved Sharp Nano Blades	





SCANLAN®

Premier™ Jacobson Micro Scissors

Flat Handle | Angled Nano Blades

Instrument blades are shown approximate size

	Cat. No.	Description	Total Length
	7007-540	25° Angled Nano Blades	6 1/4" (16 cm)
	NEW 7007-540-8		8" (20 cm)
	7007-542	45° Angled Nano Blades	6 1/4" (16 cm)
	NEW 7007-542-8		8" (20 cm)
	7007-544	60° Angled Nano Blades	6 1/4" (16 cm)
	NEW 7007-544-8		8" (20 cm)
	7007-546	90° Angled Nano Blades	6 1/8" (15.5 cm)
	NEW 7007-546-8		8" (20 cm)
	7007-548	V-Neck 125° Angled Nano Blades	6 1/8" (15.5 cm)

Please Note...

Each Scanlan instrument is individually handcrafted to provide the surgeon with the highest quality, longest-lasting, precision instrument possible. Reflecting this unique process, all stated dimensions are approximate.

Please check with your Scanlan Representative for Firm Sale status. Custom modifications available upon request.

For a complete listing of models visit... www.scanlaninternational.com

Spring Style | Flat Handle | Micro Fine Blades

7007-411

Instrument is shown approximate size





SCANLAN®

Premier™ Castroviejo Micro Scissors

Flat Handle | Angled Micro Fine Blades

Instrument blades are shown approximate size

	Cat. No.	Description	Total Length
	7007-411	25° Angled Micro Fine Blades	4 1/4" (11 cm)
	7007-413	45° Angled Micro Fine Blades	
	7007-415	60° Angled Micro Fine Blades	4 1/8" (10.5 cm)
	7007-417	90° Angled Micro Fine Blades	
	7007-419	125° Angled Micro Fine Blades	

7007-449

Instrument is shown approximate size



SCANLAN®

Premier™ Jacobson Micro Scissors

Flat Handle | V-Neck, 125° Angled Micro Fine Blades

Instrument blades are shown approximate size

	Cat. No.	Description	Total Length
	7007-449	V-Neck 125° Angled Micro Fine Blades	6 1/4" (16 cm)
	7007-449-8		8" (20 cm)



7007-442





Instrument is shown approximate size



SCANLAN®
Premier™ Jacobson Micro Scissors

Flat Handle | Angled Micro Fine Blades

Instrument blades are shown approximate size

	Cat. No.	Description	Total Length
	7007-440	25° Angled Micro Fine Blades	6 1/2" (16.5 cm)
	7007-440-8		8" (20 cm)
	7007-442	45° Angled Micro Fine Blades	6 1/2" (16.5 cm)
	7007-442-8		8" (20 cm)
	7007-444	60° Angled Micro Fine Blades	6 1/2" (16.5 cm)
	7007-444-8		8" (20 cm)
	7007-446	90° Angled Micro Fine Blades	6 1/4" (16 cm)
	7007-446-8		8" (20 cm)
	7007-448	125° Angled Micro Fine Blades	6 1/4" (16 cm)
	7007-448-8		8" (20 cm)

Please Note...

Each Scanlan instrument is individually handcrafted to provide the surgeon with the highest quality, longest-lasting, precision instrument possible. Reflecting this unique process, all stated dimensions are approximate.

Spring Style | Flat Handle | Micro Scissors

7007-140
Instrument is shown approximate size

SCISSORS

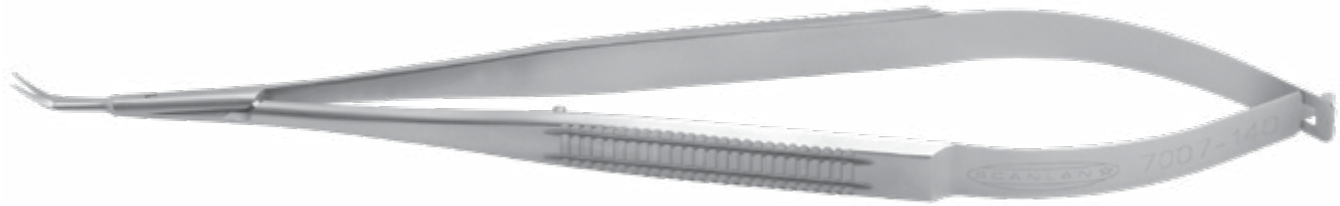

SCANLAN®

Jacobson Vannas Micro Scissors

Flat Handle | 45° Angled on Flat

Instrument blades are shown approximate size

	Cat. No.	Description	Total Length
	7007-140	45° Angled on Flat	7" (18 cm)

Please check with your Scanlan Representative for Firm Sale status. Custom modifications available upon request.
For a complete listing of models visit... www.scanlaninternational.com



SCISSORS

7007-414





Instrument is shown approximate size



SCANLAN®
Premier™ Castroviejo Micro Scissors

Flat Handle | Angled Fine Blades

Instrument blades are shown approximate size

	Cat. No.	Description	Total Length
	7007-410	25° Angled Fine Blades	4 1/2" (11.5 cm)
	7007-412	45° Angled Fine Blades	
	7007-414	60° Angled Fine Blades	
	7007-416	90° Angled Fine Blades	4 1/4" (11 cm)
	7007-418	125° Angled Fine Blades	

7007-112

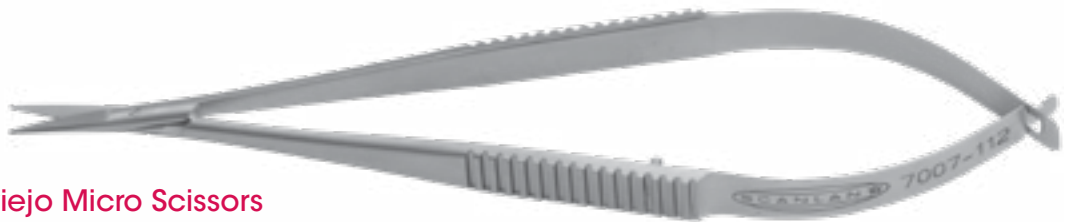

Instrument is shown approximate size



SCANLAN®
Premier™ Castroviejo Micro Scissors

Flat Handle | Fine Blades

Instrument blades are shown approximate size

	Cat. No.	Description	Total Length
	7007-112	Straight Fine Blades Sharp Tips	5 1/2" (14 cm)
	7007-116	Curved Fine Blades Sharp Tips	

Spring Style | Flat Handle | Fine Blades

7007-454

Instrument is shown approximate size

SCISSORS









SCANLAN®

Premier™ Jacobson Micro Scissors

Flat Handle | Angled Fine Blades

Instrument blades are shown approximate size

	Cat. No.	Description	Total Length
	7007-450	25° Angled Fine Blades Sharp Tips	6 1/2" (16.5 cm)
	7007-452	45° Angled Fine Blades Sharp Tips	
	7007-453	45° Angled Fine Blades Blunt Tips	
	7007-454	60° Angled Fine Blades Sharp Tips	
	7007-456	90° Angled Fine Blades Sharp Tips	6 1/4" (16 cm)
	7007-458	125° Angled Fine Blades Sharp Tips	

Please Note...
Each Scanlan instrument is individually handcrafted to provide the surgeon with the highest quality, longest-lasting, precision instrument possible. Reflecting this unique process, all stated dimensions are approximate.

Please check with your Scanlan Representative for Firm Sale status. Custom modifications available upon request.
For a complete listing of models visit... www.scanlaninternational.com









SCANLAN®

Jacobson Micro Scissors

Flat Handle | Angled Fine Blades | One Blade with Bead Tip

Instrument blades are shown approximate size

	Cat. No.	Description	Total Length
	7007-479	25° Angled Fine Blades	6 1/2" (16.5 cm)
	7007-481	45° Angled Fine Blades	
	7007-483	60° Angled Fine Blades	
	7007-485	90° Angled Fine Blades	6 1/4" (16 cm)
	7007-487	125° Angled Fine Blades	

Please Note...

Each Scanlan instrument is individually handcrafted to provide the surgeon with the highest quality, longest-lasting, precision instrument possible. Reflecting this unique process, all stated dimensions are approximate.

Spring Style | Flat Handle | Fine Blades

7007-120

Instrument is shown approximate size



SCANLAN®

Jacobson Micro Scissors

Flat Handle | Fine Blades

Instrument blades are shown approximate size

	Cat. No.	Description	Total Length
	7007-120	Straight Fine Blades Sharp Tips	7" (18 cm)
	7007-124	Curved Fine Blades Sharp Tips	
	7007-126	Curved Fine Blades Blunt Tips	

7007-470

Instrument is shown approximate size



SCANLAN®

Jacobson Micro Scissors

Flat Handle | Angled on Flat Fine Blades

Instrument blades are shown approximate size

	Cat. No.	Description	Total Length
	7007-470	25° Angled on Flat Fine Blades	7" (18 cm)

Please check with your Scanlan Representative for Firm Sale status. Custom modifications available upon request.

For a complete listing of models visit... www.scanlaninternational.com



SCISSORS

7007-506



7007-507





SCANLAN®

Puskas™ Premier™ Jacobson Micro Scissors, IMA Glide™

Flat Handle | 45° Angled Up | Fine Blades

Developed in cooperation with John D. Puskas, M.D.

Instrument blades are shown approximate size

	Cat. No.	Description	Total Length
	7007-506	LIMA, Left 90° Angled Fine Blades	8" (20 cm)
	7007-507	RIMA, Right 90° Angled Fine Blades	

Please Note...

Each Scanlan instrument is individually handcrafted to provide the surgeon with the highest quality, longest-lasting, precision instrument possible. Reflecting this unique process, all stated dimensions are approximate.

Bayonet Style | Round Handle | Micro Fine Blades

3789-01

SCISSORS



SCANLAN®

Micro Fine Scissors

Bayonet Style | Round Handle | Micro Fine Blades

Instrument blades are shown approximate size

	Cat. No.	Description	Total Length
	3789-01		8 1/4" (21 cm)
	3789-03	Straight Micro Fine Blades	9" (23 cm)
	3789-16		10" (25.4 cm)
	3789-02		8 1/4" (21 cm)
	3789-04	Curved Up Micro Fine Blades	9" (23 cm)
	3789-17		10" (25.4 cm)

Please check with your Scanlan Representative for Firm Sale status. Custom modifications available upon request.
For a complete listing of models visit... www.scanlaninternational.com











SCANLAN®

Puskas™ Premier™ Jacobson Micro Scissors

Flat Handle | Bayonet Style | Nano Blades

Developed in cooperation with John D. Puskas, M.D.

Instrument blades are shown approximate size

	Cat. No.	Description	Total Length
	7007-508	Straight Sharp Nano Blades	8" (20 cm)
	7007-509	Curved Sharp Nano Blades	
	7007-510	25° Angled Nano Blades	
	7007-511	45° Angled Nano Blades	
	7007-514	Reversed Handle 45° Angled Left Nano Blades	
	7007-521	Angled Left V-Neck 125° Angled Nano Blades	
	7007-522	Angled Right V-Neck 125° Angled Nano Blades	

Please Note...

Each Scanlan instrument is individually handcrafted to provide the surgeon with the highest quality, longest-lasting, precision instrument possible. Reflecting this unique process, all stated dimensions are approximate.

Bayonet Style | Flat Handle | Micro Fine Blades

3788-27



SCISSORS

SCANLAN®

Micro Scissors

Bayonet Style | Flat Handle | Micro Fine Blades

Instrument blades are shown approximate size

	Cat. No.	Description	Total Length
	3788-01	Straight Micro Fine Blades	8 1/4" (21 cm)
	3788-04		8 3/4" (22 cm)
	3788-06	Straight Micro Fine Blades Tenotomy Tips	9" (23 cm)
	3788-27	Curved Up Micro Fine Blades	8 3/4" (22 cm)
	3788-05		9" (23 cm)
	3788-29	Curved Down Micro Fine Blades	8 3/4" (22 cm)
	3788-02	Vannas 45° Angled on Flat Micro Fine Blades	8 3/4" (22 cm)

Please check with your Scanlan Representative for Firm Sale status. Custom modifications available upon request.
For a complete listing of models visit... www.scanlaninternational.com



SCISSORS

7007-168



SCANLAN®

Micro Circumflex Scissors

Bayonet Style | Flat Handle | Angled Fine Blades

Instrument blades are shown approximate size

	Cat. No.	Description	Total Length
	7007-167	125° Angled Fine Blades	5 1/2" (14 cm)
	7007-168		7 1/8" (18.1 cm)

Please Note...

Each Scanlan instrument is individually handcrafted to provide the surgeon with the highest quality, longest-lasting, precision instrument possible. Reflecting this unique process, all stated dimensions are approximate.

7007-252SC

SCISSORS



SCANLAN®
Diethrich-Potts Scissors

Ring Handle | Angled Blades

Instrument blades are shown approximate size

	Super Cut™ Cat. No.	Ultra Sharp® Cat. No.	Description	Total Length
	7007-250SC	7007-250	25° Angled Fine Blades	7" (18 cm)
	7007-250-5SC	7007-250-5	25° Angled Micro Fine Blades	
	7007-252SC	7007-252	45° Angled Fine Blades	
	7007-252-5SC	7007-252-5	45° Angled Micro Fine Blades	
	7007-254SC	7007-254	60° Angled Fine Blades	
	7007-254-5SC	7007-254-5	60° Angled Micro Fine Blades	
	7007-256SC	7007-256	90° Angled Fine Blades	
	7007-256-5SC	7007-256-5	90° Angled Micro Fine Blades	
	7007-258SC	7007-258	125° Angled Fine Blades	
	7007-258-5SC	7007-258-5	125° Angled Micro Fine Blades	

Please check with your Scanlan Representative for Firm Sale status. Custom modifications available upon request.
For a complete listing of models visit... www.scanlaninternational.com





SCANLAN®
Diethrich-Potts Scissors
 Ring Handle | Angled Blades

Instrument blades are shown approximate size

	Cat. No.	Description	Total Length
	7007-40	25° Angled Fine Blades	7" (18 cm)
	7007-40-5	25° Angled Micro Fine Blades	
	7007-42	45° Angled Fine Blades	
	7007-42-5	45° Angled Micro Fine Blades	
	7007-44	60° Angled Fine Blades	
	7007-44-5	60° Angled Micro Fine Blades	
	7007-46	90° Angled Fine Blades	
	7007-46-5	90° Angled Micro Fine Blades	
	7007-48	125° Angled Fine Blades	6 3/4" (17 cm)
	7007-48-5	125° Angled Micro Fine Blades	

Please Note...

Each Scanlan instrument is individually handcrafted to provide the surgeon with the highest quality, longest-lasting, precision instrument possible. Reflecting this unique process, all stated dimensions are approximate.



7007-260SC

SCISSORS



SCANLAN®
Favaloro Scissors
Ring Handle | 125° Angled Blades

Instrument blades are shown
approximate size



	Super Cut™ Cat. No.	Ultra Sharp® Cat. No.	Description	Total Length
	7007-260SC	7007-260	125° Angled Fine Blades	6 3/4" (17 cm)
	7007-260-5SC	7007-260-5	125° Angled Micro Fine Blades	

7007-50



SCANLAN®
Favaloro Scissors
Ring Handle | 125° Angled Blades

Instrument blades are shown
approximate size

	Cat. No.	Description	Total Length
	7007-50	125° Angled Fine Blades	6 3/4" (17 cm)
	7007-50-5	125° Angled Micro Fine Blades	

Please check with your Scanlan Representative for Firm Sale status. Custom modifications available upon request.
For a complete listing of models visit... www.scanlaninternational.com









SCANLAN®

Hegeman Scissors

Ring Handle | Angled Blades

Instrument blades are shown approximate size

	Cat. No.	Description	Total Length
	7007-25	25° Angled Blades	5 1/2" (14 cm)
	7007-26	45° Angled Blades	
	7007-27	60° Angled Blades	
	7007-28	90° Angled Blades	

Please Note...

Each Scanlan instrument is individually handcrafted to provide the surgeon with the highest quality, longest-lasting, precision instrument possible. Reflecting this unique process, all stated dimensions are approximate.

7007-320SC
Instrument is shown approximate size





SCISSORS



SCANLAN®
DeBakey Scissors
Ring Handle | Angled Blades

Instrument blades are shown approximate size

	Super Cut™ Cat. No.	Ultra Sharp® Cat. No.	Description	Total Length
	7007-320SC	7007-320	45° Angled Blades Blunt Tips	6 1/4" (16 cm)

Instrument blades are shown approximate size	Cat. No.	Description	Total Length
	7007-30	25° Angled Blades Blunt Tips	6 3/4" (17 cm)
	7007-33	45° Angled Blades Sharp Tips	6 1/4" (16 cm)
	7007-32	45° Angled Blades Blunt Tips	
	7007-35	60° Angled Blades Sharp Tips	
	7007-34	60° Angled Blades Blunt Tips	

Please check with your Scanlan Representative for Firm Sale status. Custom modifications available upon request.
For a complete listing of models visit... www.scanlaninternational.com





SCANLAN®

Stevens Tenotomy Scissors

Ring Handle

Instrument blades are shown approximate size

	Super Cut™ Cat. No.	Ultra Sharp® Cat. No.	Description	Total Length
	7007-208SC		Straight Blades Tenotomy Tips	4 5/8" (11.7 cm)
	7007-210SC	7007-210	Curved Blades Tenotomy Tips	4 5/8" (11.7 cm)
	7007-313SC	7007-313		6" (15 cm)
	7007-211SC	7007-211		7" (18 cm)
	7007-315SC	7007-315		8" (20 cm)

Please Note...

Each Scanlan instrument is individually handcrafted to provide the surgeon with the highest quality, longest-lasting, precision instrument possible. Reflecting this unique process, all stated dimensions are approximate.

7007-264SC

Instrument is shown approximate size

SCISSORS



SCANLAN®
Lillehei-Potts Scissors
 Ring Handle | Curved Blades

Instrument blades are shown approximate size

	Super Cut™ Cat. No.	Ultra Sharp® Cat. No.	Description	Total Length
	7007-262SC		SCANLAN® Puskas™ "Black Knight" Sharp Tips	6 1/2" (16.5 cm)
	7007-266SC		Sharp Tips	7" (18 cm)
	7007-298SC			9" (23 cm)
	7007-268SC	7007-268	Blunt Tips	7" (18 cm)
	7007-300SC	7007-300		9" (23 cm)
	7007-263SC		Tenotomy Tips	6 1/2" (16.5 cm)
	7007-264SC	7007-264		7" (18 cm)
	7007-296SC			9" (23 cm)

Please check with your Scanlan Representative for Firm Sale status. Custom modifications available upon request.
 For a complete listing of models visit... www.scanlaninternational.com





SCANLAN®

Lillehei-Potts Scissors

Ring Handle

Instrument blades are shown approximate size	Cat. No.	Description	Total Length
	7007-56	Straight Blades Sharp Tips	7" (18 cm)
	7007-58	Straight Blades Tenotomy Tips	
	7007-62	Curved Blades Sharp Tips	
	7007-60	Curved Blades Blunt Tips	
	7007-64	Curved Blades Tenotomy Tips	

Please Note...

Each Scanlan instrument is individually handcrafted to provide the surgeon with the highest quality, longest-lasting, precision instrument possible. Reflecting this unique process, all stated dimensions are approximate.

7007-218SC
Instrument is shown approximate size

SCISSORS



SCANLAN®
Metzenbaum Scissors
Ring Handle

Instrument blades are shown approximate size

	Super Cut™ Cat. No.	Ultra Sharp® Cat. No.	Description	Total Length
	7007-217SC		Straight Blades	7" (18 cm)
	7007-219SC			8" (20 cm)
	7007-221SC			9" (23 cm)
	7007-214SC	7007-214	Curved Blades	4 3/4" (12 cm)
	7007-216SC	7007-216		6" (15 cm)
	7007-218SC	7007-218		7" (18 cm)
	7007-220SC	7007-220		8" (20 cm)
	7007-222SC	7007-222		9" (23 cm)
	7007-224SC	7007-224		10 1/4" (26 cm)
	7007-226SC			12" (30.5 cm)
	7007-230SC		Curved Blades Left-Handed	7" (18 cm)



Please check with your Scanlan Representative for Firm Sale status. Custom modifications available upon request.
For a complete listing of models visit... www.scanlaninternational.com





SCANLAN®
Metzenbaum Scissors
 Ring Handle

Instrument blades are shown approximate size

	Super Cut™ Cat. No.	Ultra Sharp® Cat. No.	Description	Total Length
	7007-218-3SC		Curved Blades 2.5 mm Blunt Tips	7" (18 cm)
	7007-216-1SC	7007-216-1	Curved Blades Fine Tips	6" (15 cm)
	7007-218-1SC	7007-218-1		7" (18 cm)
	7007-220-1SC	7007-220-1		8" (20 cm)
	7007-222-1SC	7007-222-1		9" (23 cm)
	7007-224-1SC			10 1/4" (26 cm)
	7007-226-1SC			12" (30.5 cm)

Please Note...

Each Scanlan instrument is individually handcrafted to provide the surgeon with the highest quality, longest-lasting, precision instrument possible. Reflecting this unique process, all stated dimensions are approximate.

Ring Handle | Metzenbaum

7007-218-2SC
Instrument is shown approximate size

SCISSORS



SCANLAN®
Metzenbaum Scissors

Ring Handle | Tenotomy Tip

Instrument blades are shown approximate size

	Super Cut™ Cat. No.	Ultra Sharp® Cat. No.	Description	Total Length
	7007-215-2SC	7007-215-2	Straight Blades Tenotomy Tips	6" (15 cm)
	7007-223-2SC			10 1/4" (26 cm)
	7007-216-2SC	7007-216-2	Curved Blades Tenotomy Tips	6" (15 cm)
	7007-218-2SC	7007-218-2		7" (18 cm)
	7007-220-2SC			8" (20 cm)
	7007-222-2SC			9" (23 cm)
	7007-224-2SC			10 1/4" (26 cm)

Please check with your Scanlan Representative for Firm Sale status. Custom modifications available upon request.
For a complete listing of models visit... www.scanlaninternational.com



SCISSORS

7007-84

Instrument is shown approximate size



SCANLAN®

Metzenbaum Scissors

Ring Handle

Instrument blades are shown approximate size

	Cat. No.	Description	Total Length
	7007-84	Curved Blades Extra Light	7" (18 cm)

Please Note...

Each Scanlan instrument is individually handcrafted to provide the surgeon with the highest quality, longest-lasting, precision instrument possible. Reflecting this unique process, all stated dimensions are approximate.

Ring Handle | Ragnell Dissecting

7007-274SC

Instrument is shown approximate size

SCISSORS



SCANLAN®
Ragnell Dissecting Scissors
 Ring Handle

Instrument blades are shown approximate size

	Super Cut™ Cat. No.	Ultra Sharp® Cat. No.	Description	Total Length
	7007-270SC		Curved Blades Flat Tips	4 3/4" (12 cm)
	7007-272SC			6" (15 cm)
	7007-274SC	7007-274		7" (18 cm)
	7007-276SC			8" (20 cm)
	7007-278SC	7007-278		9" (23 cm)
	7007-280SC			10 1/4" (26 cm)

Please check with your Scanlan Representative for Firm Sale status. Custom modifications available upon request.
 For a complete listing of models visit... www.scanlaninternational.com





SCANLAN®
Mayo Scissors
 Ring Handle

Instrument blades are shown approximate size

	Super Cut™ Cat. No.	Ultra Sharp® Cat. No.	Description	Total Length
	7007-204SC	7007-204	Straight Round Blades	6 3/4" (17 cm)
	7007-205SC			7 1/2" (19 cm)
	7007-206SC	7007-206	Curved Round Blades	6 3/4" (17 cm)
	7007-207SC			7 1/2" (19 cm)

Please Note...

Each Scanlan instrument is individually handcrafted to provide the surgeon with the highest quality, longest-lasting, precision instrument possible. Reflecting this unique process, all stated dimensions are approximate.

Ring Handle | Mayo Harrington



7007-237SC

SCISSORS



SCANLAN®
Mayo Harrington Scissors
 Ring Handle

Instrument blades are shown approximate size

	Super Cut™ Cat. No.	Ultra Sharp® Cat. No.	Description	Total Length
	7007-232SC		Straight Blades	8" (20 cm)
	7007-236SC	7007-236	Curved Blades	8" (20 cm)
	7007-237SC	7007-237		9" (23 cm)
	7007-242SC	7007-242		12" (30.5 cm)

Please check with your Scanlan Representative for Firm Sale status. Custom modifications available upon request.
 For a complete listing of models visit... www.scanlaninternational.com



SCISSORS

7007-311SC

Instrument is shown approximate size



SCANLAN®
Mayo Scissors
 Ring Handle

Instrument blades are shown approximate size	Super Cut™ Cat. No.	Description	Total Length
	7007-311SC	Curved Blades	6" (15 cm)

1001-21



SCANLAN®
Mayo Scissors
 Ring Handle

Instrument blades are shown approximate size	Cat. No.	Description	Total Length
	1001-21	Round Blades Full Curve	7 3/4" (19.5 cm)
	1001-23		10" (25.4 cm)

Please Note...

Each Scanlan instrument is individually handcrafted to provide the surgeon with the highest quality, longest-lasting, precision instrument possible. Reflecting this unique process, all stated dimensions are approximate.





7007-286SC
Instrument is shown approximate size

SCISSORS



SCANLAN®
Iris-Eye Scissors
Ring Handle

Instrument blades are shown
approximate size

	Super Cut™ Cat. No.	Ultra Sharp® Cat. No.	Description	Total Length
	7007-282SC		Straight Blades Sharp Tips	4" (10 cm)
	7007-284SC		Straight Blades Blunt Tips	
	7007-286SC	7007-286	Curved Blades Sharp Tips	
	7007-288SC		Curved Blades Blunt Tips	

Please check with your Scanlan Representative for Firm Sale status. Custom modifications available upon request.
For a complete listing of models visit... www.scanlaninternational.com



7007-202SC

Instrument is shown approximate size



SCANLAN®
Plastic-Jabaley Scissors
 Ring Handle

Instrument blades are shown
 approximate size

	Super Cut™ Cat. No.	Ultra Sharp® Cat. No.	Description	Total Length
	7007-200SC	7007-200	Straight Blades	4 3/4" (12 cm)
	7007-202SC	7007-202	Curved Blades	

Please Note...

Each Scanlan instrument is individually handcrafted to provide the surgeon with the highest quality, longest-lasting, precision instrument possible. Reflecting this unique process, all stated dimensions are approximate.

7007-292SC

Instrument is shown approximate size



SCANLAN®
C.V.H. Scissors
Ring Handle

Instrument blades are shown approximate size	Super Cut™ Cat. No.	Ultra Sharp® Cat. No.	Description	Total Length
	7007-292SC		Straight Blades Sharp Tips	6" (15 cm)
	7007-294SC	7007-294	Curved Blades Sharp Tips	

Ring Handle | Peck Joseph

7007-295SC

Instrument is shown approximate size



SCANLAN®
Peck Joseph Scissors
Ring Handle

Instrument blades are shown approximate size	Super Cut™ Cat. No.	Ultra Sharp® Cat. No.	Description	Total Length
	7007-295SC	7007-295	Curved Blades Blunt Tips	6" (15 cm)

Please check with your Scanlan Representative for Firm Sale status. Custom modifications available upon request.
For a complete listing of models visit... www.scanlaninternational.com



Ring Handle | Sternum Pediatric

SCISSORS

7007-397SC



SCANLAN®

Sternum Pediatric Scissors

Ring Handle | Curved Blades

Instrument blades are shown approximate size	Super Cut™ Cat. No.	Description	Total Length
	7007-395SC	Side Curve	5" (12.7 cm)
	7007-397SC		8" (20 cm)

SCANLAN®

Ring Handle | Face Lift

7007-304SC



SCANLAN®

Face Lift Scissors

Ring Handle | Semi-Sharp Outer Blades

Instrument blades are shown approximate size	Super Cut™ Cat. No.	Description	Total Length
	7007-304SC	Straight Blades	7 3/4" (19.5 cm)
	7007-302SC	Curved Blades	6 1/2" (16.5 cm)
	7007-306SC		7 3/4" (19.5 cm)

Ring Handle | Laine-Kindal

7007-78

SCISSORS



SCANLAN®
Laine-Kindal Scissors

Ring Handle | Curved Blades

Instrument blades are shown approximate size

	Cat. No.	Description	Total Length
	7007-76	Sharp Tips	7 1/8" (18.1 cm)
	7007-78	Tenotomy Tips	

Ring Handle | Dissecting

7007-02

Instrument is shown approximate size



SCANLAN®
Dissecting Scissors

Ring Handle | Curved Blades

Instrument blades are shown approximate size

	Super Cut™ Cat. No.	Description	Total Length
	7007-02	Blunt Tips	5 5/8" (14.1 cm)
	7007-06	Tenotomy Tips	5 1/2" (14 cm)

Please Note...

Each Scanlan instrument is individually handcrafted to provide the surgeon with the highest quality, longest-lasting, precision instrument possible. Reflecting this unique process, all stated dimensions are approximate.

Please check with your Scanlan Representative for Firm Sale status. Custom modifications available upon request.

For a complete listing of models visit... www.scanlaninternational.com



Ring Handle | Thompson Valve

SCISSORS

8008-14



SCANLAN®

Thompson Valve Scissors

Ring Handle | Full Curved Blades

Instrument blades are shown approximate size

	Cat. No.	Description	Total Length
	8008-12	One Serrated Full Curved Blades	8 1/2" (21.5 cm)
	8008-14		10" (25.4 cm)

SCANLAN®

Ring Handle | Flemma Mitral Repair

8008-15



SCANLAN®

Flemma Mitral Repair Scissors

Ring Handle | Full Curved Blades

Instrument blades are shown approximate size

	Cat. No.	Description	Total Length
	8008-15	Round Curved Blades Flat Tips	12" (30.5 cm)

Please Note...

Each Scanlan instrument is individually handcrafted to provide the surgeon with the highest quality, longest-lasting, precision instrument possible. Reflecting this unique process, all stated dimensions are approximate.

Ring Handle | Venous Valve (In Situ)

9009-128



SCISSORS



SCANLAN®

Venous Valve Scissors (In Situ)

Ring Handle

Instrument blades are shown approximate size	Cat. No.	Description	Total Length
	9009-126	Straight Blades Blunt Tips	4" (10 cm)
	9009-128		9" (23 cm)

Please check with your Scanlan Representative for Firm Sale status. Custom modifications available upon request.
For a complete listing of models visit... www.scanlaninternational.com



SCISSORS

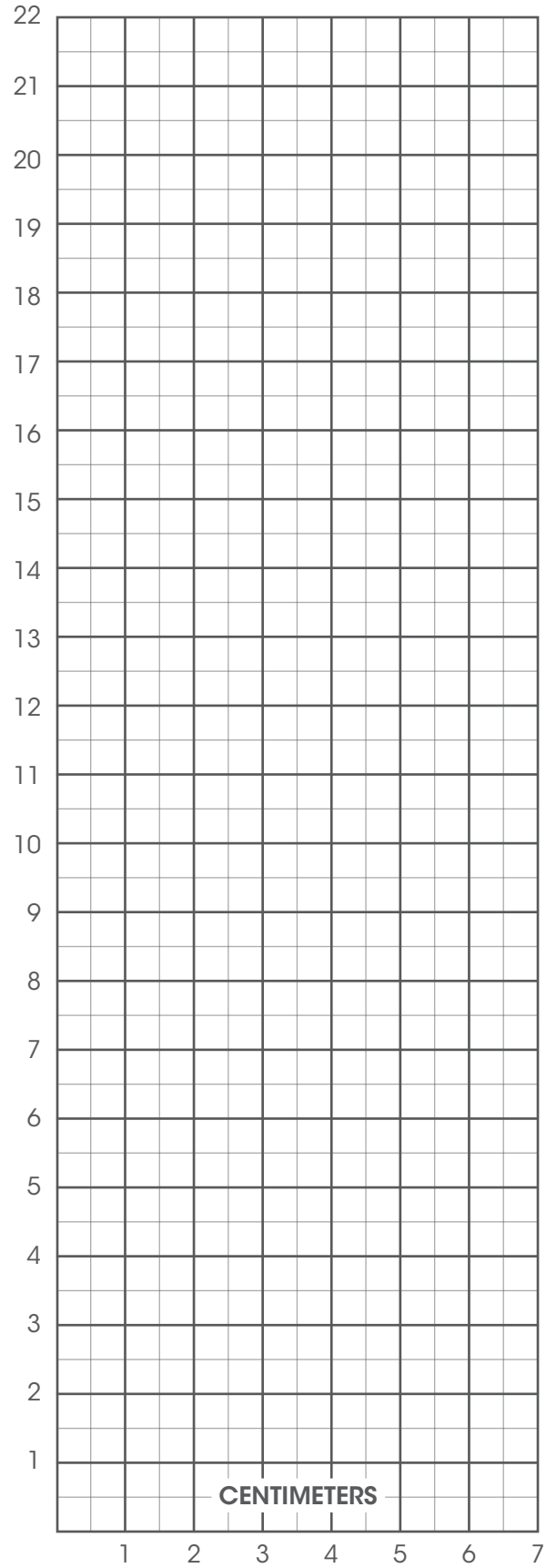
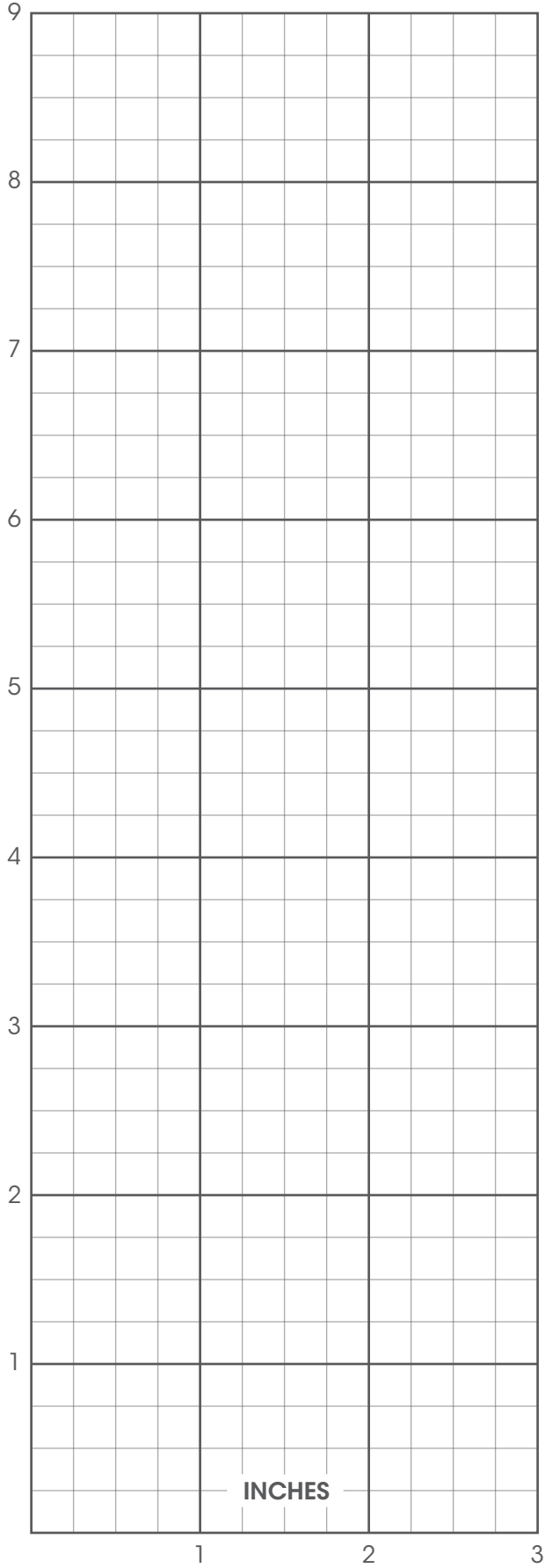

TEMPORARY OCCLUSION CLIPS / FORCEPS

- Reliance Bulldog Clamps 6.1
- Yasargil Clips 6.4
- Heifetz™ Clips 6.6

SUNDT™ GRADUATED SUCTION SYSTEM..... 6.8

SCANLAN® CALIPER / KNIFE BLADE TOOL..... 6.10

SCANLAN® MEMORY INSTRUMENTS 6.11

VASCULAR DILATORS / VESSEL PROBES

- MEMORY Vascular Dilators / Vessel Probes 6.12

STERN™ CHEST TUBE PASSER..... 6.13

Samson™ PHLEBECTOMY HOOKS 6.14

VALVULOTOMES 6.15

AORTA / VEIN PUNCHES (Re-useable) 6.16

HAND-HELD RETRACTORS

- Pediatric 6.17
- Valve 6.18
- Hooks 6.19

RETRACTORS

- M.D.® Retractor System 6.20
- Pediatric 6.24
- Loffus™ ACDF Distractor..... 6.27

DISSECTORS..... 6.28

NERVE HOOKS & PROBES..... 6.32

PLAQUE REMOVERS 6.33

INSTRUMENT SETS

- Puskas™ Coronary Instruments – Basic Set 6.34
- Puskas™ Coronary Instruments – Supplemental Set 6.36
- Puskas™ Coronary Instruments – IMA Dissection Set 6.38
- Dura Closure Set 6.40
- Loffus™ Carotid Endarterectomy Set 6.42
- Ochsner Endarterectomy Set 6.48
- EC / IC Bypass Instrument Set 6.50
- Samson™ Phlebectomy Set 6.56



SPECIALTY

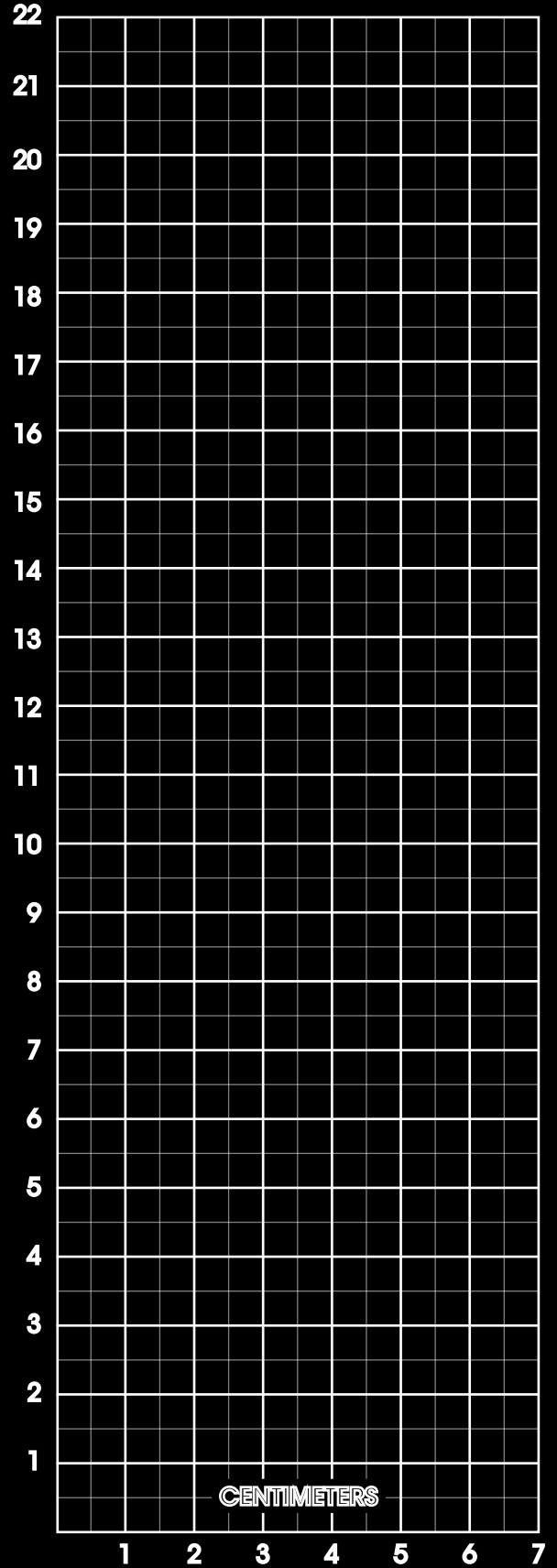
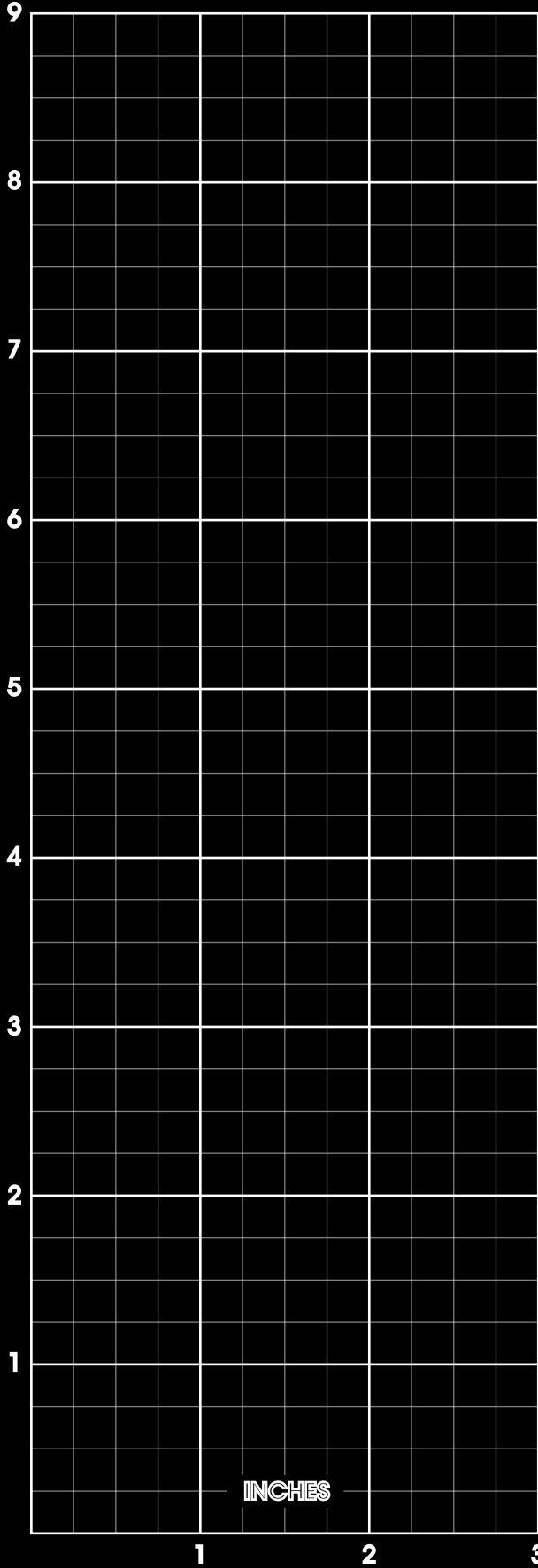







Reliance Bulldog Clamps

SPECIALTY



SCANLAN®
Reliance Bulldog Clamps
 DeBakey Jaws

		Cat. No.	Description	Total Length
Straight		3795-52	40 mm Straight DeBakey Jaws	2 3/4" (7 cm)
		3795-50	25 mm Straight DeBakey Jaws	2" (5 cm)
		3795-56	15 mm Straight DeBakey Jaws	1 5/8" (4 cm)
		3795-54	7 mm Straight DeBakey Jaws	1 1/4" (3.2 cm)
Curved		3795-51	25 mm Curved DeBakey Jaws	2" (5 cm)
		3795-57	15 mm Curved DeBakey Jaws	1 5/8" (4 cm)

For Temporary Occlusion Only. Not Intended for Implantation.
 Firm Sale – May Be Available For Evaluation

Please Note...

Each Scanlan instrument is individually handcrafted to provide the surgeon with the highest quality, longest-lasting, precision instrument possible. Reflecting this unique process, all stated dimensions are approximate.

Please check with your Scanlan Representative for Firm Sale status. Custom modifications available upon request.
 For a complete listing of models visit... www.scanlaninternational.com



Reliance Bulldog Applier / Introducer

SPECIALTY

9009-395



SCANLAN®

Reliance Bulldog Applier / Introducer

	Cat. No.	Description	Shaft	Working Length	Total Length
	9009-395	Straight Jaws With Ratchet	8 mm	13 3/4" (35 cm)	17 1/3" (44 cm)

9009-393

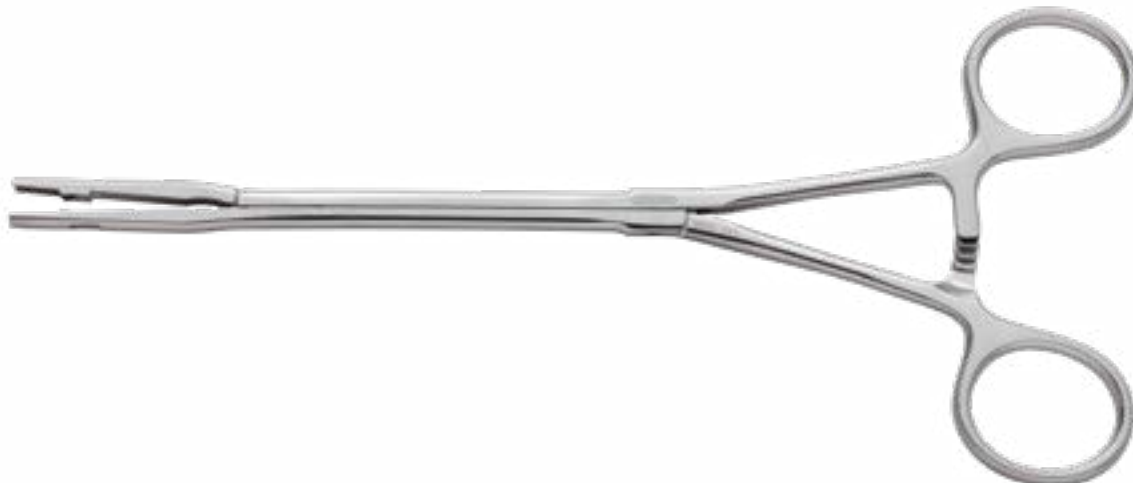

SCANLAN®

Reliance Bulldog Applier / Introducer

	Cat. No.	Description	Shaft	Working Length	Total Length
	9009-393	Straight Jaws With Ratchet	8 mm	5" (12.7 cm)	9" (23 cm)

Please Note...

Each Scanlan instrument is individually handcrafted to provide the surgeon with the highest quality, longest-lasting, precision instrument possible. Reflecting this unique process, all stated dimensions are approximate.

Reliance Bulldog Starter Pack

2135-03

SPECIALTY



2133-03



SCANLAN®

Recommended Reliance Bulldog Starter Pack

Recommended	QTY	Cat. No.	Description	Total Length
SCANLAN® V.I.P.™ Sterilization Tray	Choose 1	2133-03	SCANLAN® V.I.P.™ Micro Sterilization Tray With Scan-Guard™ Silicone Mat - Includes Hardware (Holds 3-4 Bulldogs)	1.5" x 3.5" x 1" (3.81 cm x 8.89 cm x 2.54 cm)
		2135-03	SCANLAN® V.I.P.™ Reliance Bulldog Sterilization Tray With Scan-Guard™ Silicone Mat (Holds 8-10 Bulldogs)	8 1/4" x 3 1/4" x 1 1/2" (21 cm x 8.3 cm x 3.8 cm)
Applier/Introducer	Choose 1	9009-393	Straight Jaws With Ratchet	9" (23 cm)
		9009-395		17 1/3" (44.5 cm)
SCANLAN® Reliance Bulldog Clamps	Up To 4 Of Any Combination	3795-52	40 mm Straight DeBaKey Jaws	2 3/4" (7 cm)
		3795-50	25 mm Straight DeBaKey Jaws	2" (5 cm)
		3795-56	15 mm Straight DeBaKey Jaws	1 5/8" (4 cm)
		3795-54	7 mm Straight DeBaKey Jaws	1 1/4" (3.2 cm)
		3795-51	25 mm Curved DeBaKey Jaws	2" (5 cm)
		3795-57	15 mm Curved DeBaKey Jaws	1 5/8" (4 cm)

For Temporary Occlusion Only. Not Intended for Implantation.

Please check with your Scanlan Representative for Firm Sale status. Custom modifications available upon request.

For a complete listing of models visit... www.scanlaninternational.com



Yasargil Reusable Temporary Occlusion Clips/Apppliers

SPECIALTY

3786-28



SCANLAN® Yasargil Applying Forceps – Standard

Instrument jaws are shown approximate size

	Cat. No.	Description	Total Length
	3786-28	Bayonet Style Flat Handle	7 1/8" (18.1 cm)

SCANLAN® Yasargil Clips – Light Pressure

Temporary occlusion clips are shown approximate size

	Cat. No.	Description
7 mm	3785-20	Slight Curve
	3785-21	Straight
9 mm	3785-22	Straight
	3785-24	Slight Curve
11 mm	3785-26	Straight
	3785-27	Slight Curve
15 mm	3785-41	Straight
	3785-42	Slight Curve
20 mm	3785-43	Straight

For Temporary Occlusion Only. Not Intended for Implantation.

SCANLAN® Yasargil Clips – Firm Pressure

Temporary occlusion clips are shown approximate size

	Cat. No.	Description
7 mm	3786-20	Slight Curve
	3786-21	Straight
9 mm	3786-22	Straight
	3786-23	Angled
	3786-24	Slight Curve
11 mm	3786-25	Strong Curve
	3786-26	Straight
	3786-27	Slight Curve
15 mm	3786-29	Strong Curve
	3786-41	Straight
20 mm	3786-42	Slight Curve
	3786-43	Straight

For Temporary Occlusion Only. Not Intended for Implantation.

Please Note...

Each Scanlan instrument is individually handcrafted to provide the surgeon with the highest quality, longest-lasting, precision instrument possible. Reflecting this unique process, all stated dimensions are approximate.

Yasargil Reusable Temporary Occlusion Clips/Appliers

3786-40

SPECIALTY





SCANLAN® Yasargil Applying Forceps – Mini

Instrument jaws are shown
approximate size

	Cat. No.	Description	Total Length
	3786-40	Bayonet Style Flat Handle	8 1/2" (21.5 cm)

SCANLAN® Yasargil Clips – Mini

Temporary occlusion clips are
shown approximate size

	Cat. No.	Description
4 mm 	3786-30	Straight
6 mm 	3786-31	Straight
7 mm 	3786-32	Slight Curve

For Temporary Occlusion Only. Not Intended for Implantation.

Please check with your Scanlan Representative for Firm Sale status. Custom modifications available upon request.
For a complete listing of models visit... www.scanlaninternational.com





SPECIALTY

3795-01



SCANLAN®
Heifetz™ Appliers

Instrument jaws are shown
approximate size

	Cat. No.	Description	Total Length
	3795-01	Straight	7 1/4" (18.5 cm)
	3795-01A	Angled	

Please Note...

Each Scanlan instrument is individually handcrafted to provide the surgeon with the highest quality, longest-lasting, precision instrument possible. Reflecting this unique process, all stated dimensions are approximate.





Heifetz™ Reusable Temporary Occlusion Clips/Apppliers

SPECIALTY

SCANLAN®

Heifetz™ Clips – Light Pressure Black

Temporary occlusion clips are shown approximate size





	Cat. No.	Description	
	3795-04	Straight	8 mm Jaw Length 1.75 mm Jaw Width
	3795-06	Angled On Edge	
	3795-08	Curved	
	3795-20	Straight	12 mm Jaw Length 2.25 mm Jaw Width
	3795-22	Curved	

For Temporary Occlusion Only. Not Intended for Implantation.

SCANLAN®

Heifetz™ Clips – Firm Pressure Gold

Temporary occlusion clips are shown approximate size

	Cat. No.	Description	
	3795-14	Straight	8 mm Jaw Length 1.75 mm Jaw Width
	3795-16	Angled On Edge	
	3795-18	Curved	
	3795-24	Straight	12 mm Jaw Length 2.25 mm Jaw Width
	3795-28	Curved	

For Temporary Occlusion Only. Not Intended for Implantation.

Please check with your Scanlan Representative for Firm Sale status. Custom modifications available upon request.
For a complete listing of models visit... www.scanlaninternational.com





SCANLAN®
SUNDT™ Graduated Suction System (Sets)

Each set includes seven suction tips, diameters (listed below), a universal suction handle (9009-930) and sterilization / storage case (9009-934)

Cat. No.	Description	3 Fr.	4 Fr.	5 Fr.	6 Fr.	7 Fr.	9 Fr.	11 Fr.
		•	•	•	•	•	•	•
9009-940	4 1/2" (11.5 cm) Rotatable Suction Tip Set	9009-941	9009-942	9009-943	9009-944	9009-945	9009-947	9009-949
9009-950	4 1/2" (11.5 cm) Non-Rotatable Suction Tip Set	9009-951	9009-952	9009-953	9009-954	9009-955	9009-957	9009-959
9009-960	5 1/4" (13.5 cm) Rotatable Suction Tip Set	9009-961	9009-962	9009-963	9009-964	9009-965	9009-967	9009-969
9009-970	5 1/4" (13.5 cm) Non-Rotatable Suction Tip Set	9009-971	9009-972	9009-973	9009-974	9009-975	9009-977	9009-979
9009-980	7 7/8" (19.8 cm) Rotatable Suction Tip Set	9009-981	9009-982	9009-983	9009-984	9009-985	9009-987	9009-989
9009-990	7 7/8" (19.8 cm) Non-Rotatable Suction Tip Set	9009-991	9009-992	9009-993	9009-994	9009-995	9009-997	9009-999

SCANLAN®
SUNDT™ Graduated Suction Parts and Tray

9009-930

Cat. No.	Description	Total Length
9009-928	Brush Set, Pack Of Ten (for 9009-940 9009-950, 9009-960 and 9009-970)	
9009-928-3	Brush Set, Pack Of Ten (for 9009-941 9009-951, 9009-961 and 9009-971)	
9009-929	Brush Set, Pack Of Ten (for 9009-980 and 9009-990)	
9009-929-3	Brush Set, Pack Of Ten (for 9009-981 and 9009-991)	
9009-930	Universal Suction Handle (fits all tip lengths and French sizes)	3" (7.5 cm)
9009-934	SCANLAN® V.I.P.™ Sundt Sterilization / Storage Tray, SCAN-GUARD™ Silicone Mat (fits all tips / lengths and handle)	6" x 10" x 1.5" (15.2 x 25.4 x 3.8 cm)



Silicone mat in tray is not made with natural rubber latex.

Please Note...

Each Scanlan instrument is individually handcrafted to provide the surgeon with the highest quality, longest-lasting, precision instrument possible. Reflecting this unique process, all stated dimensions are approximate.

SUNDT™ Graduated Suction Systems

SPECIALTY

SCANLAN®
4 1/2" (11.5 cm) Tips
 for SUNDT™ Graduated Suction Systems



3 Fr. 4 Fr. 5 Fr. 6 Fr. 7 Fr. 9 Fr. 11 Fr.
 • • • • • • •

Rotatable	9009-941	9009-942	9009-943	9009-944	9009-945	9009-947	9009-949
Non-Rotatable	9009-951	9009-952	9009-953	9009-954	9009-955	9009-957	9009-959

SCANLAN®
5 1/4" (13.5 cm) Tips
 for SUNDT™ Graduated Suction Systems



3 Fr. 4 Fr. 5 Fr. 6 Fr. 7 Fr. 9 Fr. 11 Fr.
 • • • • • • •

Rotatable	9009-961	9009-962	9009-963	9009-964	9009-965	9009-967	9009-969
Non-Rotatable	9009-971	9009-972	9009-973	9009-974	9009-975	9009-977	9009-979

SCANLAN®
7 7/8" (19.8 cm) Tips
 for SUNDT™ Graduated Suction Systems



3 Fr. 4 Fr. 5 Fr. 6 Fr. 7 Fr. 9 Fr. 11 Fr.
 • • • • • • •

Rotatable	9009-981	9009-982	9009-983	9009-984	9009-985	9009-987	9009-989
Non-Rotatable	9009-991	9009-992	9009-993	9009-994	9009-995	9009-997	9009-999

SUNDT™ Graduated Suction Tips do not include Universal Suction Handle (9009-930)

Please check with your Scanlan Representative for Firm Sale status. Custom modifications available upon request.
 For a complete listing of models visit... www.scanlaninternational.com



Caliper

SPECIALTY

8008-400



SCANLAN®
Caliper

Cat. No.	Description	Total Length
8008-400	Scale With Black Matte Finish, Ring Handle	11" (28 cm)

SCANLAN®

Knife Tool

8008-405

Instrument is shown approximate size

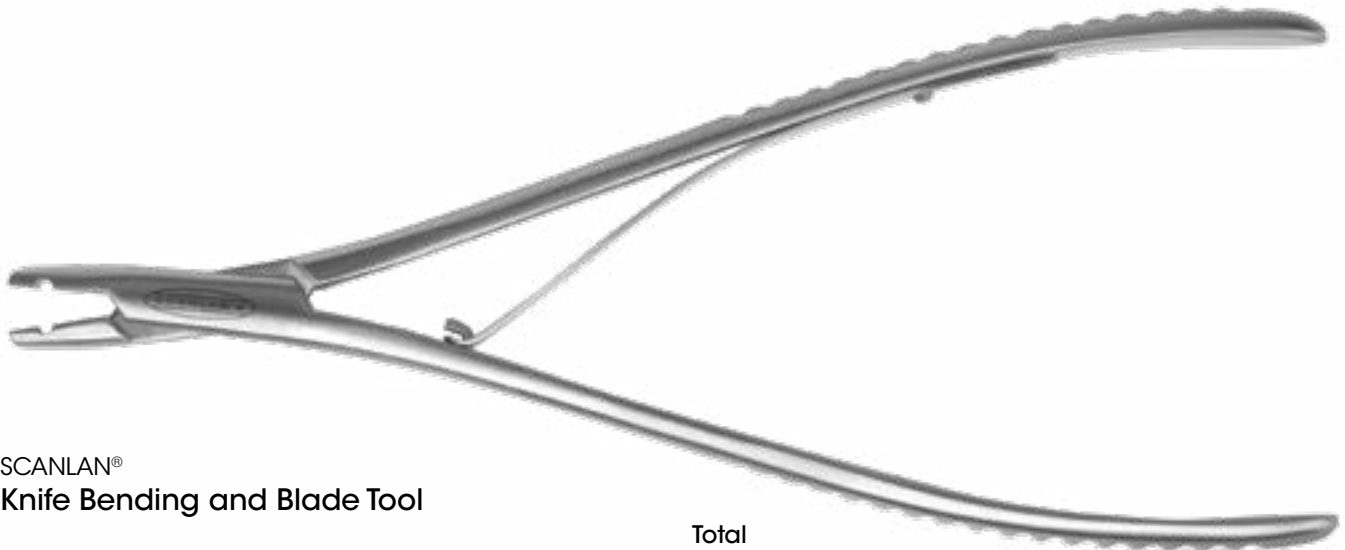

SCANLAN®

Knife Bending and Blade Tool

Cat. No.	Description	Total Length
8008-405	DIAMOND DUST™ Jaws Open Spring Handle (for use with SCANLAN® MEMORY Knife Handle 8008-410)	7" (18 cm)

Please Note...

Each Scanlan instrument is individually handcrafted to provide the surgeon with the highest quality, longest-lasting, precision instrument possible. Reflecting this unique process, all stated dimensions are approximate.

8008-430



8008-410







8008-420



SCANLAN®
MEMORY Instruments

Instrument tips are shown
approximate size

	Cat. No.	Description	Total Length
	8008-410	Knife Handle, Nitinol Shaft, Stainless Steel Flat Handle, Fits #15 And #11 Blades	9 1/2" (24 cm)
	8008-420	Mirror Instrument, Nitinol Shaft, Stainless Steel Round Handle, 1.5 X Magnification, 2 Pieces (handle, mirror)	9 7/8" (25 cm)
	8008-420-4	Replacement Mirror for MEMORY Mirror Instrument (8008-420), 1.5 X Magnification	
	8008-430	Nerve Hook, Nitinol Shaft And Angled Tapered Tip, Stainless Steel Round Handle	10" (25.4 cm)
	8008-432	Nerve Hook, Nitinol Shaft And Angled Flat Tip, Stainless Steel Round Handle	10" (25.4 cm)



Note:
The detachable mirror for the SCANLAN® MEMORY Mirror Instrument is guaranteed to be free from defects in materials and workmanship for 90-days. It is not covered under the SCANLAN® 10-Year Warranty.

Nitinol is a metal alloy which is flexible and has shape memory. This means that the nitinol portion of the instrument can be bent by the user to a desired curved shape for use. The instrument will return back to its original shape when exposed to a temperature of 60°C - 90°C (140° - 194°F). Steam autoclaving exceeds this temperature and is the recommended method to return the nitinol portion of the instrument back to the original shape.

Please check with your Scanlan Representative for Firm Sale status. Custom modifications available upon request.
For a complete listing of models visit... www.scanlaninternational.com



MEMORY Vascular Dilators & Vessel Probes





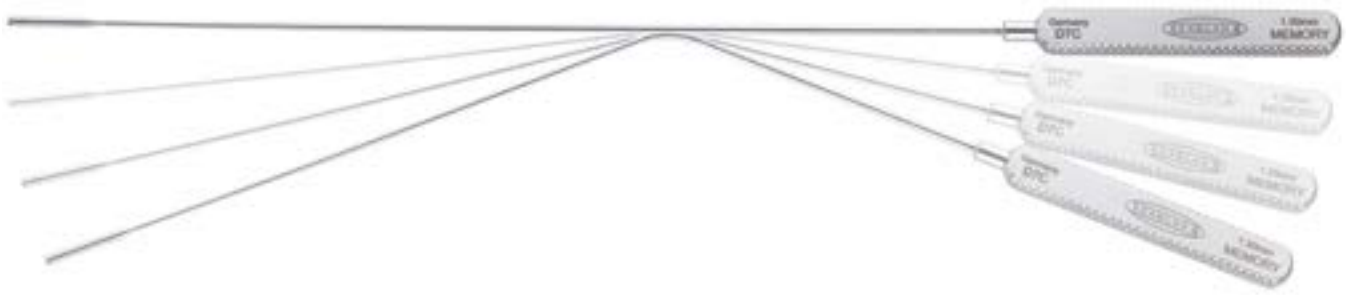





SPECIALTY



8008-474



SCANLAN®

MEMORY Garrett Vascular Dilators & Vessel Probes

Shown approximate size	5 1/2" (14 cm) Cat. No.	8 1/4" (21 cm) Cat. No.	Description
	8008-448A	8008-449A	0.5 mm
	8008-448B	8008-449B	1.25 mm
	8008-448C	8008-449C	1.75 mm
	8008-452	8008-472	1 mm
	8008-454	8008-474	1.5 mm
	8008-456	8008-476	2 mm
	8008-458	8008-478	2.5 mm
	8008-460	8008-480	3 mm
	8008-462	8008-482	3.5 mm
	8008-464	8008-484	4 mm
	8008-466	8008-486	4.5 mm
	8008-468	8008-488	5 mm

Shown approximate size	8 1/4" (21 cm) Cat. No.	Description
	8008-493	1 / 1.5 mm
	8008-494	1.5 / 2 mm
	8008-495	2 / 2.5 mm

Please Note...

Each Scanlan instrument is individually handcrafted to provide the surgeon with the highest quality, longest-lasting, precision instrument possible. Reflecting this unique process, all stated dimensions are approximate.

4004-185

SPECIALTY



SCANLAN®

Stern™ Chest Tube Passer

Cat. No.	Description	Total Length
4004-185	Without Ratchet	9 3/4" (24.8 cm)
4004-186	With Ratchet	
4004-189	Without Ratchet	14" (35.6 cm)

Please check with your Scanlan Representative for Firm Sale status. Custom modifications available upon request.

For a complete listing of models visit... www.scanlaninternational.com



Phlebectomy Hooks

SPECIALTY



SCANLAN®
Samson™ Phlebectomy Hooks, Black Platinum Handle
Designed in cooperation with Russell H. Samson, M.D.

Cat. No.	Description	Total Length
8008-230	Right Short	4 1/4" (11 cm)
8008-232	Left Short	
8008-236	Right Long	5 1/2" (14 cm)

Firm Sale - May Be Available For Evaluation

Please Note...

Each Scanlan instrument is individually handcrafted to provide the surgeon with the highest quality, longest-lasting, precision instrument possible. Reflecting this unique process, all stated dimensions are approximate.





SCANLAN®
In Situ Valvulotomes

Cat. No.	Description	Total Length
9009-121		9" (23 cm)
9009-122	0.8 mm Cutting Edge (Retrograde)	10" (25.4 cm)
9009-123		12" (30.5 cm)
9009-120	Set Of Three (one each) 9009-121, -122, -123	

Please check with your Scanlan Representative for Firm Sale status. Custom modifications available upon request.
For a complete listing of models visit... www.scanlaninternational.com



SPECIALTY

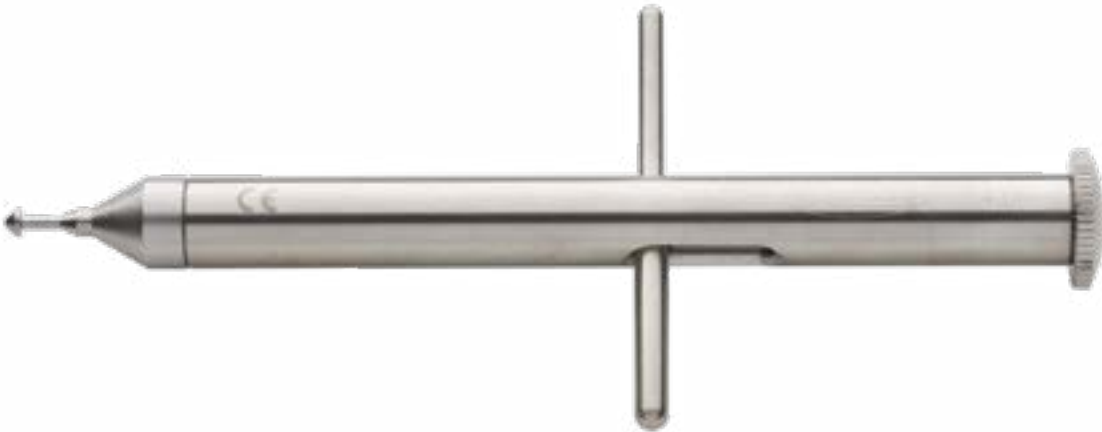

1001-04

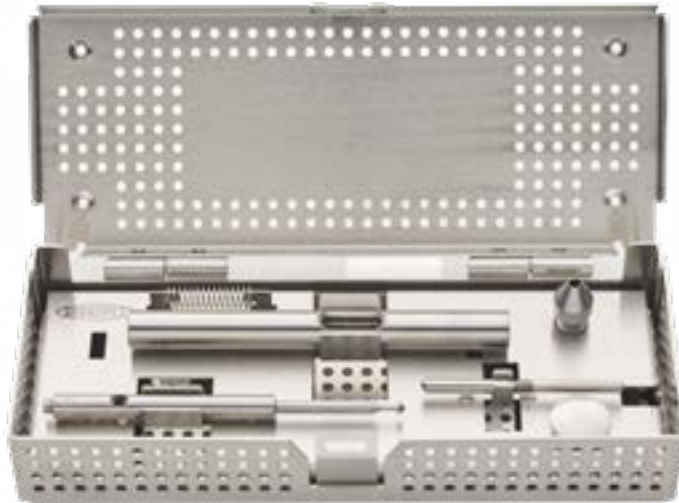

2135-04

SCANLAN®
Aorta / Vein Punch

Cat. No.	Description
1001-04	4.0 mm with Sterilizing Box & Tray
1001-05	4.5 mm with Sterilizing Box & Tray
2135-04	SCANLAN® V.I.P.™ A/V Punch Sterilization Tray, with insert 8.25" x 3.25" x 1.5" (21 x 8.3 x 3.8 cm)

Please Note...

Each Scanlan instrument is individually handcrafted to provide the surgeon with the highest quality, longest-lasting, precision instrument possible. Reflecting this unique process, all stated dimensions are approximate.

1001-10

SPECIALTY



SCANLAN®

Cochran Pediatric Retractors

Cat. No.	Description
1001-14	1/4" (6.4 mm) Wide, 6 1/2" (16.5 cm) Long
1001-13	3/8" (9.5 mm) Wide, 6 1/2" (16.5 cm) Long
1001-12	1/2" (12.7 mm) Wide, 6 1/2" (16.5 cm) Long
1001-11	5/8" (15.6 mm) Wide, 6 1/2" (16.5 cm) Long
1001-10	3/4" (19 mm) Wide, 6 1/2" (16.5 cm) long

Please check with your Scanlan Representative for Firm Sale status. Custom modifications available upon request.

For a complete listing of models visit... www.scanlaninternational.com



SPECIALTY

8008-02



SCANLAN®

Ionescu Valve Retractors

Cat. No.	Description	Total Length
8008-02	Double-Ended Leaflet Valve Retractor, Small 6.0 mm And 7.5 mm	8 1/4" (21 cm)

8008-04



SCANLAN®

Ionescu Valve Retractors

Cat. No.	Description	Total Length
8008-04	Double-Ended Valve Retractor, Medium Curved 12 mm And 17 mm	7 1/8" (18.1 cm)

8008-06



SCANLAN®

Ionescu Valve Retractors

Cat. No.	Description	Total Length
8008-06	Double-Ended Valve Retractor, Large Curved 22 mm And 25 mm	9" (23 cm)

Please Note...

Each Scanlan instrument is individually handcrafted to provide the surgeon with the highest quality, longest-lasting, precision instrument possible. Reflecting this unique process, all stated dimensions are approximate.

Hand-Held Retractors – Hooks

8008-10

SPECIALTY



SCANLAN®

Bryant Mitral Hooks

Cat. No.	Description	Total Length
8008-10	Two Semi-Sharp Points	10 3/4" (27.3 cm)
8008-11	One Semi-Sharp Point	

Please check with your Scanlan Representative for Firm Sale status. Custom modifications available upon request.

For a complete listing of models visit... www.scanlaninternational.com



SPECIALTY

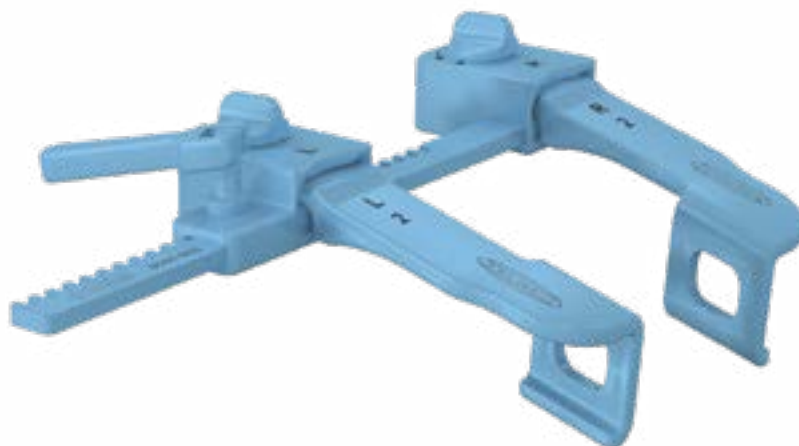

Two Rack Sizes

To allow proper patient fit.

Unique Patented Locking System

for a secure, reliable hold of interchangeable arms.

Interchangeable Retractor Arms

Five unique sizes to ensure proper patient fit.



Scan-Vu®

Radiolucent Arms (Single-Use)



M.D.® Titanium Retractor Arms (Reusable)

Designed for light weight, reliable retraction for open surgical procedures.

Durability

Designed with the highest quality materials for reliability & longevity.

SCANLAN® M.D.® RETRACTOR SYSTEM was developed in cooperation with Francis X. Moga, MD and Ginny Dixon, BSN, RN, CNOR, RNFA

Patent No. 10383613

Please Note...

Each Scanlan instrument is individually handcrafted to provide the surgeon with the highest quality, longest-lasting, precision instrument possible. Reflecting this unique process, all stated dimensions are approximate.



**NEW**

SCANLAN®

M.D.® Retractor System – Size 1Set
8888-901

Cat. No.	Description	Arm Length	Blade Depth	Blade Width
8008-903	M.D.® Titanium Rack, 3" (76 mm) Spread			
8008-911	SCANLAN® Scan-Vu® Radiolucent Single-use Retractor Arms Size 1 Left and Right (1 pair per sterile package)*	1.8" (46 mm)	0.37" (9.5 mm)	0.5" (13 mm)
8008-931R	SCANLAN® M.D.® Titanium Retractor Arm Size 1 Right Arm			
8008-931L	SCANLAN® M.D.® Titanium Retractor Arm Size 1 Left Arm			

**NEW**

SCANLAN®

M.D.® Retractor System – Size 2Set
8888-902

Cat. No.	Description	Length	Blade Depth	Blade Width
8008-903	M.D.® Titanium Rack, 3" (76 mm) Spread			
8008-912	SCANLAN® Scan-Vu® Radiolucent Single-use Retractor Arms Size 2 Left and Right (1 pair per sterile package)*	2.3" (58 mm)	0.63" (16 mm)	0.9" (23 mm)
8008-932R	SCANLAN® M.D.® Titanium Retractor Arm, Size 2 Right Arm			
8008-932L	SCANLAN® M.D.® Titanium Retractor Arm, Size 2 Left Arm			

Please check with your Scanlan Representative for Firm Sale status. Custom modifications available upon request.

For a complete listing of models visit... www.scanlaninternational.com

M.D.® Retractor System

SPECIALTY



NEW

SCANLAN®

M.D.® Retractor System – Size 3

Set
8888-903

Cat. No.	Description	Length	Blade Depth	Blade Width
8008-905	M.D.® Titanium Rack, 5" (127 mm) Spread			
8008-913	SCANLAN® Scan-Vu® Radiolucent Single-use Retractor Arms Size 3 Left and Right (1 pair per sterile package)*	3.0" (76 mm)	0.87" (22 mm)	1.4" (36 mm)
8008-933R	SCANLAN® M.D.® Titanium Retractor Arm, Size 3 Right Arm			
8008-933L	SCANLAN® M.D.® Titanium Retractor Arm, Size 3 Left Arm			



NEW

SCANLAN®

M.D.® Retractor System – Size 4

Set
8888-904

Cat. No.	Description	Length	Blade Depth	Blade Width
8008-905	M.D.® Titanium Rack, 5" (127 mm) Spread			
8008-914	SCANLAN® Scan-Vu® Radiolucent Single-use Retractor Arms, Size 4 Left and Right (1 pair per sterile package)*	3.5" (89 mm)	1.14" (29 mm)	1.8" (45 mm)
8008-934R	SCANLAN® M.D.® Titanium Retractor Arm, Size 4 Right Arm			
8008-934L	SCANLAN® M.D.® Titanium Retractor Arm, Size 4 Left Arm			

Please Note...

Each Scanlan instrument is individually handcrafted to provide the surgeon with the highest quality, longest-lasting, precision instrument possible. Reflecting this unique process, all stated dimensions are approximate.

M.D.® Retractor System

SPECIALTY



NEW

SCANLAN®

M.D.® Retractor System – Size 5

Set
8888-905

Cat. No.	Description	Length	Blade Depth	Blade Width
8008-905	M.D.® Titanium Rack, 5" (127 mm) Spread			
8008-915	SCANLAN® Scan-Vu® Radiolucent Single-use Retractor Arms, Size 5 Left and Right (1 pair per sterile package)*	4.3" (109 mm)	1.38" (35 mm)	2.6" (67 mm)
8008-935R	SCANLAN® M.D.® Titanium Retractor Arm, Size 5 Right Arm			
8008-935L	SCANLAN® M.D.® Titanium Retractor Arm, Size 5 Left Arm			



NEW

SCANLAN®

V.I.P.™ Sterilization Tray

Cat. No.	Description	Dimension
2151-03	Aluminum with Scan-Guard™	17"x 10.5"x 1.88" (43.2 cm x 26.7 cm x 4.8 cm)

New tray designed to accommodate all size variations for quick selection based on patient size.

Please check with your Scanlan Representative for Firm Sale status. Custom modifications available upon request.
For a complete listing of models visit... www.scanlaninternational.com





SCANLAN®
Pediatric Retractor

Cat. No.	Description	Spread	Arms	Blades
8008-43	Retractor With Interchangeable Blades Titanium	52 mm	40 mm	1 Pair: 10 mm Long x 15 mm Deep 1 Pair: 20 mm Long x 15 mm Deep

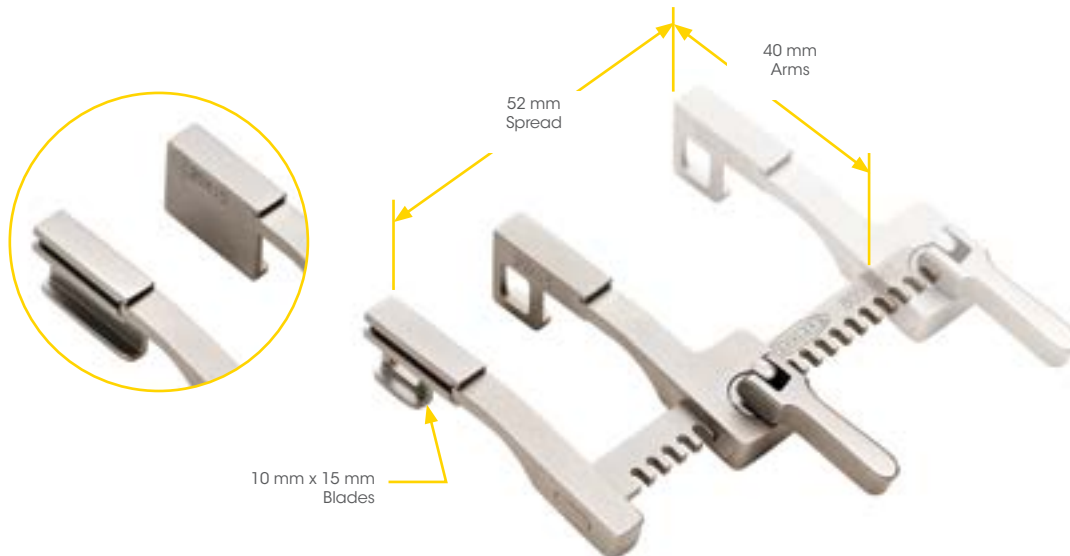

Please Note...

Each Scanlan instrument is individually handcrafted to provide the surgeon with the highest quality, longest-lasting, precision instrument possible. Reflecting this unique process, all stated dimensions are approximate.

Self-Retaining Retractors – Pediatric

8008-41

Instrument is shown approximate size



SCANLAN®

Pediatric Finochietto Neonate Retractor

Cat. No.	Description	Spread	Arms	Blades
8008-41	Finochietto Neonate Sternal Retractor Stainless Steel	36 mm	25 mm	7 mm Long x 7 mm Deep

8008-42

Instrument is shown approximate size



SCANLAN®

Pediatric Finochietto Neonate Retractor

Cat. No.	Description	Spread	Arms	Blades
8008-42	Finochietto Neonate Sternal Retractor Titanium	36 mm	25 mm	7 mm Long x 7 mm Deep

Please check with your Scanlan Representative for Firm Sale status. Custom modifications available upon request.

For a complete listing of models visit... www.scanlaninternational.com



8008-45



SCANLAN®

Bailey Finochietto Sternal Retractors

Cat. No.	Description	Spread	Arms	Blades
8008-45	Bailey Finochietto Sternal Retractor Titanium	80 mm	57 mm	20 mm Long x 20 mm Deep

8008-47



SCANLAN®

Bailey Finochietto Sternal Retractors

Cat. No.	Description	Spread	Arms	Blades
8008-47	Bailey Finochietto Sternal Retractor Aluminum	80 mm	56 mm	15 mm Long x 15 mm Deep

Please Note...

Each Scanlan instrument is individually handcrafted to provide the surgeon with the highest quality, longest-lasting, precision instrument possible. Reflecting this unique process, all stated dimensions are approximate.

LOFTUS™ ACDF Distractor

8008-81

Instrument is shown approximate size

SPECIALTY



SCANLAN®
LOFTUS™ ACDF Distractor

Cat. No.	Description
8008-81	Loftus™ Two Level ACDF Distractor

Please check with your Scanlan Representative for Firm Sale status. Custom modifications available upon request.
 For a complete listing of models visit... www.scanlaninternational.com



9009-106



SCANLAN®
Olivecrona Double-Ended Dissectors

Cat. No.	Description	Total Length
9009-100		7" (18 cm)
9009-104	With Ligature Guide	7 3/4" (19.7 cm)
9009-106		9 1/2" (24 cm)
9009-110	Without Ligature Guide	9 1/2" (24 cm)

9009-146



SCANLAN®
Ochsner Double-Ended Dissectors

Cat. No.	Description	Total Length
9009-144	1 mm & 2 mm	7 1/8" (18.1 cm)
9009-146	3 mm & 4 mm	

Please Note...

Each Scanlan instrument is individually handcrafted to provide the surgeon with the highest quality, longest-lasting, precision instrument possible. Reflecting this unique process, all stated dimensions are approximate.

3784-451



SCANLAN®
Jacobson Retrograde Knives / Dissectors with Ball Tip

Cat. No.	Description	Total Length
3784-451	Ball Tip Bayonet Handle	7 1/2" (19 cm)

3784-45



SCANLAN®
Yasargil Micro Arachnoidal Knives

Cat. No.	Description	Total Length
3784-44	Curved Upwards Bayonet Handle	7 1/4" (18.5 cm)
3784-45	Curved Downward Bayonet Handle	

3784-80



Firm Sale - May be available for evaluation

SCANLAN®
Dissector Instrument Tray

Cat. No.	Description	Total Length
3784-80	SCANLAN® V.I.P.™ Metal Sterilization Trays (instruments not included)	9" x 5" x 2" (23 cm x 12.7 cm x 5 cm)

Please check with your Scanlan Representative for Firm Sale status. Custom modifications available upon request.
For a complete listing of models visit... www.scanlaninternational.com



SPECIALTY

3784-12



SCANLAN®
Yasargil Angled Micro Raspatories

Cat. No.	Description	Total Length
3784-12	Small	7 1/4" (18.5 cm)
3784-11	Large	
3784-09	Angled	

SCANLAN®
Pennfield Dissector

Cat. No.	Description	Total Length
3781-16	Blunt 3 mm Curved Tip	8 3/4" (22 cm)
3781-10	Blunt 6 mm Tip	7 1/4" (18.5 cm)

3784-40



SCANLAN®
Yasargil Micro Raspatories

Cat. No.	Description	Total Length
3784-40	Curved Downward Bayonet Handle	7 1/4" (18.5 cm)
3784-41	Curved Upwards Bayonet Handle	
3784-42	Slightly Curved Bayonet Handle	
3784-13	Strongly Curved Bayonet Handle	
3784-10	Round Handle Painted	

Please Note...

Each Scanlan instrument is individually handcrafted to provide the surgeon with the highest quality, longest-lasting, precision instrument possible. Reflecting this unique process, all stated dimensions are approximate.

3784-43



SCANLAN®
Yasargil Micro Curette

Cat. No.	Description	Total Length
3784-43	Micro Curette Bayonet Style	7 1/4" (18.5 cm)

9009-142



SCANLAN®
Ochsner Angled Delicate Plane Finder Dissector

Cat. No.	Description	Total Length
9009-142	Angled With Ball	7 1/2" (19 cm)

3003-800



SCANLAN®
Titanium Probe

Cat. No.	Description	Total Length
3003-800	Probe	10" (25.4 cm)

Please check with your Scanlan Representative for Firm Sale status. Custom modifications available upon request.
For a complete listing of models visit... www.scanlaninternational.com



Micro Nerve Hooks & Probes

SPECIALTY

3784-32



SCANLAN®
Krayenbuhl Micro Nerve and Vessel Hooks

Cat. No.	Description	Total Length
3784-32	Small	7 1/4" (18.5 cm)
3784-33	Large	

3784-31



SCANLAN®
Krayenbuhl Micro Nerve and Vessel Hooks

Cat. No.	Description	Total Length
3784-30	Pointed Small	7 1/4" (18.5 cm)
3784-31	Pointed Large	

3784-14



SCANLAN®
Jacobson Micro Probes

Cat. No.	Description	Total Length
3784-14	Angled	7 1/4" (18.5 cm)
3784-15	Straight 2-Probes	

Please Note...

Each Scanlan instrument is individually handcrafted to provide the surgeon with the highest quality, longest-lasting, precision instrument possible. Reflecting this unique process, all stated dimensions are approximate.

9009-150
Instrument is shown approximate size

SPECIALTY



SCANLAN®
Ochsner Plaque Remover

Cat. No.	Description	Total Length
9009-150	Curved Fine Tips	6 1/8" (15.5 cm)
9009-152	Straight Fine Tips	

Please check with your Scanlan Representative for Firm Sale status. Custom modifications available upon request.
For a complete listing of models visit... www.scanlaninternational.com



Puskas™ Coronary Instruments – Basic Set

SPECIALTY

SCANLAN®

Puskas™ Coronary Instruments – Basic Set

Basic Set

9999-100

Set Includes Items Listed on Pages 6.34 – 6.35

SCANLAN®

LEGACY Micro Forceps, Titanium

Never Shear™ Dual Guide™ | Round Handle | 10 mm Diameter Knurling

Qty.	Cat. No. 0.5 mm Tips	Cat. No. 1.0 mm Tips	Description	Total Length
1	3003-770		Puskas™ Straight DIAMOND DUST™ Platform Tips 1 x 2 Micro Teeth	7 1/8" (18.1 cm)
1		3003-778		8 1/4" (21 cm)
2	3003-810		Puskas™ Bayonet Style Straight 0.5 mm Straight DIAMOND DUST™ 1 x 2 Micro Teeth	8 3/4" (22 cm)

The Never Shear™ Dual Guide™ design was developed in cooperation with John D. Puskas, MD
DUAL GUIDE™ Patent No. 8,147,512

3003-770



3003-778



3003-810



3003-390



3003-381



SCANLAN®

LEGACY Puskas™ Jacobson Micro Needle Holders, Titanium

8 mm Diameter Extended Knurling | Round Handle

Qty.	Cat. No.	Description	Recommended Suture Size	Total Length
1	3003-390	Straight DIAMOND DUST™ Jaws Streamline Box Lock With Ratchet	5-0 and Smaller	9" (23 cm)
1	3003-381	Straight DIAMOND DUST™ Jaws Regular Box Lock With Ratchet	7-0 and Smaller	8 1/4" (21 cm)

Please Note...

Each Scanlan instrument is individually handcrafted to provide the surgeon with the highest quality, longest-lasting, precision instrument possible. Reflecting this unique process, all stated dimensions are approximate.

Puskas™ Coronary Instruments – Basic Set

Set Includes Items Listed on Pages 6.34 – 6.35

7007-262SC



SPECIALTY

SCANLAN®

Lillehei-Potts Scissors

Ring Handle | Curved Blades

Qty.	Super Cut™ Cat. No.	Description	Total Length
1	7007-262SC	SCANLAN® Puskas™ "Black Knight" Sharp Tips	6 1/2" (16.5 cm)

7007-511



7007-521



SCANLAN®

Puskas™ Premier™ Jacobson Micro Scissors

Bayonet Handle | Nano Blades

Developed in cooperation with John D. Puskas, M.D.

Qty.	Super Cut™ Cat. No.	Description	Total Length
1	7007-511	45° Angled Nano Blades	8" (20 cm)
1	7007-521	Angled Left, V-Neck 125° Angled Nano Blades	

2140-03



SCANLAN®

V.I.P.™ Metal Sterilization Tray

Qty.	Cat. No.	Description	Dimensions	Capacity
1	2140-03	Silver-Gray Color Aluminum	10" x 15" x 1.5" (25.4 x 38 x 3.8 cm)	10-12

Please check with your Scanlan Representative for Firm Sale status. Custom modifications available upon request.
For a complete listing of models visit... www.scanlaninternational.com



Puskas™ Coronary Instruments – Supplemental Set

SPECIALTY

SCANLAN®

Puskas™ Coronary Instruments – Supplemental Set

Designed in cooperation with John D. Puskas, M.D.

Supplemental Set

9999-101

Set Includes Items Listed on Pages 6.36 – 6.37

3003-774



3003-775



3003-776



SCANLAN®

LEGACY Micro Forceps, Titanium

Never Shear™ Dual Guide™ | Round Handle | 10 mm Diameter Knurling

Qty.	Cat. No. 0.5 mm Tips	Description	Total Length
1	3003-774	Puskas™ Straight DIAMOND DUST™ Platform Tips 1 x 2 Micro Teeth	8 1/4" (21 cm)
1	3003-775	Puskas™ Curved DIAMOND DUST™ Platform Tips 1 x 2 Micro Teeth	8 1/4" (21 cm)
1	3003-776	Puskas™ Angled DIAMOND DUST™ Platform Tips 1 x 2 Micro Teeth	8 1/4" (21 cm)

The Never Shear™ Dual Guide™ design was developed in cooperation with John D. Puskas, MD
DUAL GUIDE™ Patent No. 8,147,512

3003-391



SCANLAN®

LEGACY Puskas™ Jacobson Micro Needle Holders, Titanium

8 mm Diameter Extended Knurling | Round Handle

Qty.	Cat. No.	Description	Recommended Suture Size	Total Length
1	3003-391	Straight DIAMOND DUST™ Jaws Regular Box Lock With Ratchet	7-0 and Smaller	9 1/2" (24 cm)

Please Note...

Each Scanlan instrument is individually handcrafted to provide the surgeon with the highest quality, longest-lasting, precision instrument possible. Reflecting this unique process, all stated dimensions are approximate.

Puskas™ Coronary Instruments – Supplemental Set

Set Includes Items Listed on Pages 6.36 – 6.37

SPECIALTY



SCANLAN®
Puskas™ Premier™ Jacobson Micro Scissors
 Flat Handle | Bayonet Style | Nano Blades
 Developed in cooperation with John D. Puskas, M.D.

Qty.	Cat. No.	Description	Total Length
1	7007-514	Reversed Handle 45° Angled Left Nano Blades	8" (20 cm)
1	7007-522	Angled Right, V-Neck 125° Angled Nano Blades	

2138-03



SCANLAN®
V.I.P.™ Metal Sterilization Tray

Qty.	Cat. No.	Description	Dimensions	Capacity
1	2138-03	Silver-Gray Color Aluminum	10" x 10" x 1.5" (25.4 x 25.4 x 3.8 cm)	10-12

Please check with your Scanlan Representative for Firm Sale status. Custom modifications available upon request.
 For a complete listing of models visit... www.scanlaninternational.com



Puskas™ Coronary Instruments – IMA Dissection Set

SPECIALTY

SCANLAN®

Puskas™ Coronary Instruments – IMA Dissection Set

IMA Dissection Set
9999-102

Set Includes Items Listed on Pages 6.38 – 6.39

3003-779



SCANLAN®

LEGACY Micro Forceps, Titanium

Never Shear™ Dual Guide™ | Round Handle | 10 mm Diameter Knurling

Qty.	Cat. No.	Description	Total Length
1	3003-779	Puskas™ Angled DIAMOND DUST™ Platform Tips 1 x 2 Micro Teeth	8 1/4" (21 cm)

The Never Shear™ Dual Guide™ design was developed in cooperation with John D. Puskas, MD
DUAL GUIDE™ Patent No. 8,147,512

7007-506



7007-507



SCANLAN®

Puskas™ Premier™ Jacobson Micro Scissors

Flat Handle | 45° Up Angled | IMA Glide™
Developed in cooperation with John D. Puskas, M.D.

Qty.	Cat. No.	Description	Total Length
1	7007-506	LIMA, Left 90° Angled Fine Blades	8" (20 cm)
1	7007-507	RIMA, Right 90° Angled Fine Blades	

Please Note...

Each Scanlan instrument is individually handcrafted to provide the surgeon with the highest quality, longest-lasting, precision instrument possible. Reflecting this unique process, all stated dimensions are approximate.

Puskas™ Coronary Instruments – IMA Dissection Set

Set Includes Items Listed on Pages 6.38 – 6.39

7007-262SC



SPECIALTY

SCANLAN®

Lillehei-Potts Scissors

Ring Handle | Curved Blades

Qty.	Super Cut™ Cat. No.	Description	Total Length
1	7007-262SC	SCANLAN® Puskas™ "Black Knight" Sharp Tips	6 1/2" (16.5 cm)

2138-03



SCANLAN®

V.I.P.™ Metal Sterilization Tray

Qty.	Cat. No.	Description	Dimensions	Capacity
1	2138-03	Silver-Gray Color Aluminum	10" x 10" x 1.5" (25.4 x 25.4 x 3.8 cm)	10-12

Please check with your Scanlan Representative for Firm Sale status. Custom modifications available upon request.
For a complete listing of models visit... www.scanlaninternational.com



Dura Closure Set

SPECIALTY

SCANLAN®

Dura Closure Set Designed in cooperation with John D. Puskas, M.D.

Dura Closure Set
9999-109

Set Includes Items Listed on Pages 6.40 – 6.41

9009-360



SCANLAN®

Minimally Invasive Fine Needle Holder – Ring Handle

Qty.	Cat. No.	Description	Total Length
1	9009-360	DIAMOND DUST™ Jaws Curved Sideways (5 mm) With Ratchet	11 1/2" (29 cm)

9009-364



SCANLAN®

Minimally Invasive Jacobson Needle Holder – Spring Style

Qty.	Cat. No.	Description	Total Length
1	9009-364	Round Handle 30° Angled Down DIAMOND DUST™ Curved Jaws	12 1/2" (32 cm)

9009-380



SCANLAN®

Minimally Invasive Chitwood Knot Tier / Pusher – Spring Style

Qty.	Cat. No.	Description	Total Length
1	9009-380	30° Angled Down Fine End For 5.0 Suture or Smaller	11 3/4" (30 cm)

Please Note...

Each Scanlan instrument is individually handcrafted to provide the surgeon with the highest quality, longest-lasting, precision instrument possible. Reflecting this unique process, all stated dimensions are approximate.

Set Includes Items Listed on Pages 6.40 – 6.41

2145-02



SCANLAN®

V.I.P.™ Dura Closure Set Metal Sterilization Tray

Qty.	Cat. No.	Description	Dimensions	Capacity
1	2145-02	SCANLAN® Metal Sterilization Tray, Aluminum, Scan-Guard™ Silicone Inserts, Detachable Lid	10" x 16" x 2.5" (25.4 cm x 40.6 cm x 6.4 cm)	4-5

SCANLAN®

Dura Closure Set (Optional Instruments)

SCANLAN®

SUPER CUT™ Scissors

Developed in cooperation with W. Randolph Chitwood Jr., MD

Cat. No.	Description	Shaft	Working Length	Total Length
9009-716SC	Straight Fine Blades 1 cm Blade Length Blunt Micro Tips Black Platinum Ring Handle	5 mm	6 1/2" (16.5 cm)	10 1/2" (27 cm)
9009-718SC	Curved Fine Blades 1 cm Blade Length Blunt Micro Tips Black Platinum Ring Handle			

SCANLAN®

Micro Forceps

Bayonet Style | Round Handle

Cat. No.	Description	Total Length
3789-20	0.8 mm Straight Tips	10" (25.4 cm)

Please check with your Scanlan Representative for Firm Sale status. Custom modifications available upon request.

For a complete listing of models visit... www.scanlaninternational.com

Loftus™ Carotid Endarterectomy Set

SPECIALTY

SCANLAN®

Loftus™ Carotid Endarterectomy Set Developed in cooperation with Christopher M. Loftus, M.D.

Loftus Carotid Endarterectomy Set

9999-181

Set Includes Items Listed on Pages 6.42 – 6.47

2002-235



3003-614



4377-08



9009-148



SCANLAN®

Clamps

Qty.	Cat. No.	Description	Total Length
1	2002-235	SCANLAN® Baby Vascular Clamp Cooley Jaws 45° Angled Jaws	5 3/4" (14.6 cm)
1	3003-614	SCANLAN® Micro Clamp, Titanium 60° Angled Jaws 23 mm Jaw Length	4 1/8" (10.5 cm)
1	4377-08	SCANLAN® DeBakey Cooley Forceps Carmalt Jaws with Cross Hatch Tips Right Angled Jaws	7 1/2" (19 cm)
1	9009-148	SCANLAN® Ochsner Forceps 90° Angled Very Fine Serrated Jaws	4 1/2" (11.5 cm)

Please Note...

Each Scanlan instrument is individually handcrafted to provide the surgeon with the highest quality, longest-lasting, precision instrument possible. Reflecting this unique process, all stated dimensions are approximate.

Loftus™ Carotid Endarterectomy Set

Set Includes Items Listed on Pages 6.42 – 6.47

SPECIALTY



SCANLAN® Forceps

Qty.	Cat. No.	Description	Total Length
1	3003-04	Scanlan® DeBakey Dissecting Forceps Straight DeBakey 2 mm Tips Flat Handle	7 3/4" (19.5 cm)
1	3003-05	Scanlan® DeBakey Dissecting Forceps Straight DeBakey 1 mm Tips Flat Handle	7 3/4" (19.5 cm)
1	3003-158-8	Scanlan® Micro Forceps Straight DIAMOND DUST™ Platform Tips Round Handle	8 1/4" (21 cm)
1	3003-720	Scanlan® Dennis Micro Forceps 1 mm Straight DIAMOND DUST™ Ring Tips Round Handle	7" (18 cm)

3003-234-1



SCANLAN® Needle Holders

Qty.	Cat. No.	Description	Recommended Suture Size	Total Length
1	3003-234-1	SCANLAN® Jacobson Micro Needle Holder Straight Fine DIAMOND DUST™ Jaws Streamline Box Lock With Ratchet	5-0 and Smaller	8 1/2" (21.5 cm)

Please check with your Scanlan Representative for Firm Sale status. Custom modifications available upon request.
For a complete listing of models visit... www.scanlaninternational.com



Loftus™ Carotid Endarterectomy Set

SPECIALTY

Set Includes Items Listed on Pages 6.42 – 6.47



SCANLAN®
Super Cut™ Scissors

Qty.	Cat. No.	Description	Total Length
1	7007-211SC	Stevens Tenotomy Scissors Curved Blades Tenotomy Tips Ring Handle	7" (18 cm)
1	7007-218-3SC	Metzenbaum Scissors Curved Blades 2.5 mm Blunt Tips Ring Handle	7" (18 cm)
1	7007-254SC	Diethrich-Potts Scissors 60° Angled Micro Blades Ring Handle	7" (18 cm)
1	7007-320SC	DeBakey Scissors 45° Angled Blades Blunt Tips Ring Handle	6 1/4" (16 cm)

Please Note...

Each Scanlan instrument is individually handcrafted to provide the surgeon with the highest quality, longest-lasting, precision instrument possible. Reflecting this unique process, all stated dimensions are approximate.

Loftus™ Carotid Endarterectomy Set

Set Includes Items Listed on Pages 6.42 – 6.47

4385-42

SPECIALTY



SCANLAN®

Loftus™ Titanium Bulldog Shunt Clamps

Qty: One of the Following

Cat. No.	Description		Total Length
4385-40	10° Angled	10 Fr. ●	3 3/4" (9.5 cm)
4385-42	25° Angled		
4385-44	45° Angled		
4385-46	60° Angled		
4384-40	10° Angled	12 Fr. ●	
4384-42	25° Angled		
4384-44	45° Angled		
4384-46	60° Angled		
4383-40	10° Angled	14 Fr. ●	
4383-42	25° Angled		
4383-44	45° Angled		
4383-46	60° Angled		

(Set includes one of the following shunt clamps. Please indicate choice when placing order.)

9009-144



9009-146



SCANLAN®

Ochsner Double-Ended Dissectors

Qty.	Cat. No.	Description	Total Length
1	9009-144	1 mm & 2 mm	7 1/8" (18.1 cm)
1	9009-146	3 mm & 4 mm	

Please check with your Scanlan Representative for Firm Sale status. Custom modifications available upon request.
For a complete listing of models visit... www.scanlaninternational.com



Loftus™ Carotid Endarterectomy Set

SPECIALTY

Set Includes Items Listed on Pages 6.42 – 6.47

1001-506



SCANLAN®
VASCU-STATT® Applier

Qty.	Cat. No.	Description	Total Length
1	1001-506	VASCU-STATT® Applier Straight	8 1/2" (21.5 cm)

1001-550



SCANLAN®
VASCU-STATT® Plus

Qty.	Cat. No.	Description
1	1001-550	VASCU-STATT® Plus Midi Straight

1001-76



SCANLAN®
SURG-I-LOOP®

Qty.	Cat. No.	Description	Total Length
1	1001-76	SURG-I-LOOP® Red, Maxi	16 1/2" (42 cm)

Please Note...

Each Scanlan instrument is individually handcrafted to provide the surgeon with the highest quality, longest-lasting, precision instrument possible. Reflecting this unique process, all stated dimensions are approximate.

Loftus™ Carotid Endarterectomy Set

Set Includes Items Listed on Pages 6.42 – 6.47

2081-23



SPECIALTY

SCANLAN®

V.I.P.™ Sterilization Tray, Plastic

Cat. No.	Description	Dimensions	Capacity
2081-23	Plastic Clasps Additional 1/2 Tray Insert Scan-Guard™ Silicone Mats	15" x 10" x 1.5" (38 x 25.4 cm x 3.8 cm)	15+

2142-03



SCANLAN®

V.I.P.™ Metal Sterilization Tray

Cat. No.	Description	Dimensions	Capacity
2142-03	Silver-gray color, Scan-Guard™ silicone insert across full width of base, additional tray insert	10" x 15" x 2.6" (25.4 cm x 38 cm x 6.6 cm)	18+

Please indicate choice of sterilization tray at time of order.

Please check with your Scanlan Representative for Firm Sale status. Custom modifications available upon request.

For a complete listing of models visit... www.scanlaninternational.com

Ochsner Endarterectomy Set

SPECIALTY

SCANLAN®

Ochsner Endarterectomy Set Developed in cooperation with John L. Ochsner, M.D.

Ochsner Endarterectomy Set

9999-192

Set Includes Items Listed on Pages 6.48 – 6.49

SCANLAN® Clamps

Qty.	Cat. No.	Description	Total Length
1	9009-148	SCANLAN® Ochsner Forceps 90° Angled Very Fine Serrated Jaws	4 1/2" (11.5 cm)



SCANLAN® Forceps

Qty.	Cat. No.	Description	Total Length
1	4004-37	SCANLAN® DeBaKey Needle Pulling Tissue Forceps 2 mm Straight Carbon-inlay Tips Flat Handle (Gold Handle)	7 1/2" (19 cm)
1	4004-224	SCANLAN® Dennis Micro Forceps 1 mm Straight DIAMOND DUST™ Ring Tips Counterbalanced	8 1/4" (21 cm)



SCANLAN® Ochsner Dissectors

Qty.	Cat. No.	Description	Total Length
1	9009-142	Angled Delicate Plane Finder Dissector, Angled With Ball	7 1/2" (19 cm)
1	9009-144	Double-Ended Dissectors 1 mm & 2 mm	7 1/8" (18.1 cm)
1	9009-146	Double-Ended Dissectors 3 mm & 4 mm	



Please Note...

Each Scanlan instrument is individually handcrafted to provide the surgeon with the highest quality, longest-lasting, precision instrument possible. Reflecting this unique process, all stated dimensions are approximate.

Ochsner Endarterectomy Set

Set Includes Items Listed on Pages 6.48 – 6.49

SPECIALTY

9009-150



9009-152



SCANLAN®
Ochsner Plaque Remover

Qty.	Cat. No.	Description	Total Length
1	9009-150	Curved Fine Tips Ring Handle	6 1/8" 15.5 cm)
1	9009-152	Straight Fine Tips Ring Handle	

2138-03



SCANLAN®
V.I.P.™ Metal Sterilization Tray

Qty.	Cat. No.	Description	Dimensions	Capacity
1	2138-03	Silver-Gray Color Aluminum Scan-Guard™ Silicone Inserts	10" x 10" x 1.5" (25.4 x 25.4 x 3.8 cm)	10-12

Please check with your Scanlan Representative for Firm Sale status. Custom modifications available upon request.
For a complete listing of models visit... www.scanlaninternational.com



EC / IC Bypass Instrument Set

SPECIALTY

SCANLAN®

EC / IC Bypass Instrument Total Set

Total Set

9999-166

Total set includes three subsets (9999-162, 9999-163, 9999-164) and are listed on pages 6.50 – 6.55
EC / IC Bypass Instrument Set may be purchased as a set or as individual components.

SCANLAN®

EC / IC Bypass Instrument Subset #1

Total Set

9999-162

3003-154-3



3003-156-3



3003-164



4004-03-3A



SCANLAN®

Forceps

Round Handle

Qty.	Cat. No.	Description	Total Length
1	3003-154-3	SCANLAN® Micro Suture Tying Forceps, Titanium 0.3 mm Straight Platform Gerald Type Taper DIAMOND DUST™ Tips	6" (15 cm)
1	3003-156-3	SCANLAN® Micro Suture Tying Forceps, Titanium 0.3 mm Curved Platform Gerald Type Taper DIAMOND DUST™ Tips	
1	3003-164	SCANLAN® Micro Forceps, Titanium 1 mm Straight DIAMOND DUST™ Ring Tips	
1	4004-03-3A	SCANLAN® Micro Suture Tying Forceps, Stainless Steel 0.3 mm Angled 45° Angled DIAMOND DUST™	5 1/2" (14 cm)

Please Note...

Each Scanlan instrument is individually handcrafted to provide the surgeon with the highest quality, longest-lasting, precision instrument possible. Reflecting this unique process, all stated dimensions are approximate.

EC / IC Bypass Instrument Set

Total set includes three subsets (9999-162, 9999-163, 9999-164) and are listed on pages 6.50 – 6.55
EC / IC Bypass Instrument Set may be purchased as a set or as individual components.

6006-56-3



SPECIALTY

SCANLAN®
Needle Holders
Round Handle

Qty.	Cat. No.	Description	Recommended Suture Size	Total Length
1	6006-56-3	SCANLAN® Castroviejo Micro Needle Holder, Stainless Steel 0.3 mm Tapered Curved DIAMOND DUST™ Jaws Regular Box Lock Without Ratchet	8-0 and Smaller	5 3/4" (14.5 cm)

7007-140



SCANLAN®
Jacobson Vannas Micro Scissors
Flat Handle

Qty.	Cat. No.	Description	Total Length
1	7007-140	SCANLAN® Jacobson Vannas Micro Scissors 45° Angled Micro Fine Blades Stainless Steel	7" (18 cm)

Optional SCANLAN® V.I.P.™ Sterilization Trays

Cat. No.	Description	Dimensions	Capacity
2138-03	Silver-gray color Scan-Guard™ Silicone Inserts	10" x 10" x 1.5" (25.4 x 25.4 x 3.8 cm)	8-10
2140-03	Silver-gray color Scan-Guard™ Silicone Inserts	10" x 15" x 1.5" (25.4 x 38 x 3.8 cm)	10-12
2141-03	Silver-gray color, base with accessory compartment Scan-Guard™ Silicone Inserts	10" x 15" x 2.6" (25.4 x 38 x 6.6 cm)	15+

Please check with your Scanlan Representative for Firm Sale status. Custom modifications available upon request.
For a complete listing of models visit... www.scanlaninternational.com



EC / IC Bypass Instrument Set

SPECIALTY

SCANLAN®

EC / IC Bypass Instrument Total Set

Total Set

9999-166

Total set includes three subsets (9999-162, 9999-163, 9999-164) and are listed on pages 6.50 – 6.55
EC / IC Bypass Instrument Set may be purchased as a set or as individual components.

SCANLAN®

EC / IC Bypass Instrument Subset #2

Total Set

9999-163

Set Includes The Items Listed On Pages 6.52 – 6.53

3003-158-3



3003-159-3



3003-164



4004-97-3A



SCANLAN®

Forceps

Round Handle

Qty.	Cat. No.	Description	Total Length
1	3003-158-3	SCANLAN® Micro Forceps, Titanium Gerald Type Taper 0.3 mm Straight DIAMOND DUST™ Platform Tips	7 1/4" (18.5 cm)
1	3003-159-3	SCANLAN® Micro Forceps, Titanium Gerald Type Taper 0.3 mm Curved DIAMOND DUST™ Platform Tips	7 1/4" (18.5 cm)
1	3003-164	SCANLAN® Micro Forceps, Titanium 1 mm Straight DIAMOND DUST™ Ring Tips	6" (15 cm)
1	4004-97-3A	SCANLAN® Micro Forceps, Stainless Steel 0.3 mm Angled DIAMOND DUST™ 45° Angled	5 1/2" (14 cm)

Please Note...

Each Scanlan instrument is individually handcrafted to provide the surgeon with the highest quality, longest-lasting, precision instrument possible. Reflecting this unique process, all stated dimensions are approximate.

EC / IC Bypass Instrument Set

Total set includes three subsets (9999-162, 9999-163, 9999-164) and are listed on pages 6.50 – 6.55
EC / IC Bypass Instrument Set may be purchased as a set or as individual components.

3003-177-3



SPECIALTY

SCANLAN®

Jacobson Micro Needle Holders

Round Handle

Qty.	Cat. No.	Description	Recommended Suture Size	Total Length
1	3003-177-3	SCANLAN® Jacobson Micro Needle Holder, Titanium 0.3 mm Tapered Curved DIAMOND DUST™ Jaws Regular Box Lock Without Ratchet	8-0 and Smaller	7 1/4" (18.5 cm)

7007-140



SCANLAN®

Scissors

Flat Handle

Qty.	Cat. No.	Description	Total Length
1	7007-140	SCANLAN® Jacobson Vannas Micro Scissors 45° Angled Micro Fine Blades Spring Style Flat Handle	7" (18 cm)

Please check with your Scanlan Representative for Firm Sale status. Custom modifications available upon request.

For a complete listing of models visit... www.scanlaninternational.com



EC / IC Bypass Instrument Set

SPECIALTY

SCANLAN®

EC / IC Bypass Instrument Total Set

Total Set
9999-166

Total set includes three subsets (9999-162, 9999-163, 9999-164) and are listed on pages 6.50 – 6.55
EC / IC Bypass Instrument Set may be purchased as a set or as individual components.

SCANLAN®

EC / IC Bypass Instrument Subset #3

Total Set
9999-164

Set Includes The Items Listed On Pages 6.54 – 6.55



SCANLAN®

Forceps

Bayonet Style | Flat Handle

Qty.	Cat. No.	Description	Total Length
1	3003-842	SCANLAN® Micro Forceps, Titanium 0.3 mm Straight DIAMOND DUST™ Tips	8 3/4" (22 cm)
1	3003-841	SCANLAN® Micro Forceps, Titanium 0.3 mm 45° Angle DIAMOND DUST™ Tips	
1	3003-840	SCANLAN® Micro Forceps, Titanium 0.3 mm Curved Up DIAMOND DUST™ Tips	
1	3003-851	SCANLAN® Micro Forceps, Titanium 1 mm DIAMOND DUST™ Ring Tips	

Please Note...

Each Scanlan instrument is individually handcrafted to provide the surgeon with the highest quality, longest-lasting, precision instrument possible. Reflecting this unique process, all stated dimensions are approximate.

EC / IC Bypass Instrument Set

Total set includes three subsets (9999-162, 9999-163, 9999-164) and are listed on pages 6.50 – 6.55
EC / IC Bypass Instrument Set may be purchased as a set or as individual components.

3789-14-3



SPECIALTY

SCANLAN®

Micro Needle Holders

Bayonet Style | Round Handle

Qty.	Cat. No.	Description	Recommended Suture Size	Total Length
1	3789-14-3	SCANLAN® Micro Needle Holder, Stainless Steel 0.3 mm Curved Up DIAMOND DUST™ Jaws Regular Box Lock Without Ratchet	8-0 and Smaller	9" (23 cm)

3788-02



SCANLAN®

Micro Scissors

Bayonet Style | Flat Handle

Qty.	Cat. No.	Description	Total Length
1	3788-02	SCANLAN® Micro Scissors Vannas 45° Angled Up On Flat Micro Fine Blades	8 3/4" (22 cm)

Optional SCANLAN® V.I.P.™ Sterilization Trays

Cat. No.	Description	Dimensions	Capacity
2138-03	Silver-gray color Scan-Guard™ Silicone Inserts	10" x 10" x 1.5" (25.4 x 25.4 x 3.8 cm)	8-10
2140-03	Silver-gray color Scan-Guard™ Silicone Inserts	10" x 15" x 1.5" (25.4 x 38 x 3.8 cm)	10-12
2141-03	Silver-gray color, base with accessory compartment, Scan-Guard™ Silicone Inserts	10" x 15" x 2.6" (25.4 x 38 x 6.6 cm)	15+

Please check with your Scanlan Representative for Firm Sale status. Custom modifications available upon request.

For a complete listing of models visit... www.scanlaninternational.com



Samson™ Phlebectomy Set – Plastic V.I.P.™ Sterilization Tray

SPECIALTY

SCANLAN®
Samson™ Phlebectomy Set
 Set
 9999-150

Set Includes Items Listed on Pages 6.56 – 6.57

8008-230



8008-236



SCANLAN®
Samson™ Phlebectomy Hooks, Black Platinum Handle

Designed in cooperation with Russell H. Samson, M.D.

Qty.	Cat. No.	Description	Total Length
1	8008-230	Right Short	4 1/4" (11 cm)
1	8008-236	Right Long	5 1/2" (14 cm)

5005-86



5005-88



SCANLAN®
Delicate Mosquito Forceps

Qty.	Cat. No.	Description	Total Length
1	5005-86	Very Fine Curved Jaws	5" (12.7 cm)
1	5005-88	Curved Jaws 1 x 2 Teeth	

5005-82



SCANLAN®
Vascular Mosquito Forceps

Qty.	Cat. No.	Description	Total Length
1	5005-82	Curved Jaws Sharp Grasping Serrations	5" (12.7 cm)

Please Note...

Each Scanlan instrument is individually handcrafted to provide the surgeon with the highest quality, longest-lasting, precision instrument possible. Reflecting this unique process, all stated dimensions are approximate.

Samson™ Phlebectomy Set – Plastic V.I.P.™ Sterilization Tray

Set Includes Items Listed on Pages 6.56 – 6.57

7007-210SC



SPECIALTY

SCANLAN®

Stevens Tenotomy Scissors

Ring Handle

Qty.	Super Cut™ Cat. No.	Description	Total Length
1	7007-210SC	Curved Blades Tenotomy Tips	4 5/8" (11.7 cm)

2081-11

SCANLAN®

V.I.P.™ Plastic Sterilization Tray

Qty.	Cat. No.	Description	Dimensions	Capacity
1	2081-11	Scan-Guard™ Silicone Mats	10" x 6" x 0.7" (25.4 cm x 15 cm x 1.8 cm)	6-10



Samson™ Phlebectomy Set – Optional Products

SCANLAN®

Samson™ Phlebectomy Hooks, Black Platinum Handle

Designed in cooperation with Russell H. Samson, M.D.

Qty.	Cat. No.	Description	Total Length
1	8008-232	Left Short	4 1/4" (11 cm)

SCANLAN®

Phlebectomy Haemostat

Qty.	Cat. No.	Description	Total Length
1	5005-80	90° Angled Very Fine Jaws Sharp Grasping Serrations	4 1/2" (11.5 cm)

SCANLAN®

Surgical Skin Markers

Cat. No.	Description
1001-710	Gentian Violet Regular Tip

Please check with your Scanlan Representative for Firm Sale status. Custom modifications available upon request.

For a complete listing of models visit... www.scanlaninternational.com

SCANLAN®
Samson™ Phlebectomy Set
 Set
 9999-151

Set Includes Items Listed on Pages 6.58 – 6.59

8008-230



8008-236



SCANLAN®
Samson™ Phlebectomy Hooks, Black Platinum Handle

Designed in cooperation with Russell H. Samson, M.D.

Qty.	Cat. No.	Description	Total Length
1	8008-230	Right Short	4 1/4" (11 cm)
1	8008-236	Right Long	5 1/2" (14 cm)

5005-86



5005-88



SCANLAN®
Delicate Mosquito Forceps

Qty.	Cat. No.	Description	Total Length
1	5005-86	Very Fine Curved Jaws	5" (12.7 cm)
1	5005-88	Curved Jaws 1 x 2 Teeth	

5005-82



SCANLAN®
Vascular Mosquito Forceps

Qty.	Cat. No.	Description	Total Length
1	5005-82	Curved Jaws Sharp Grasping Serrations	5" (12.7 cm)

Please Note...

Each Scanlan instrument is individually handcrafted to provide the surgeon with the highest quality, longest-lasting, precision instrument possible. Reflecting this unique process, all stated dimensions are approximate.

Samson™ Phlebectomy Set – Metal V.I.P.™ Sterilization Tray

Set Includes Items Listed on Pages 6.58 – 6.59

7007-210SC



SPECIALTY

2138-03

SCANLAN®

Stevens Tenotomy Scissors

Ring Handle

Qty.	Super Cut™ Cat. No.	Description	Total Length
1	7007-210SC	Curved Blades Tenotomy Tips	4 5/8" (11.7 cm)

SCANLAN®

V.I.P.™ Metal Sterilization Tray

Qty.	Cat. No.	Description	Dimensions	Capacity
1	2138-03	Silver-Gray Color Aluminum Scan-Guard™ Silicone Inserts	10" x 10" x 1.5" (25.4 x 25.4 x 3.8 cm)	10-12



Samson™ Phlebectomy Set – Optional Products

SCANLAN®

Samson™ Phlebectomy Hooks, Black Platinum Handle

Designed in cooperation with Russell H. Samson, M.D.

Qty.	Cat. No.	Description	Total Length
1	8008-232	Left Short	4 1/4" (11 cm)

SCANLAN®

Phlebectomy Haemostat

Qty.	Cat. No.	Description	Total Length
1	5005-80	90° Angled Very Fine Jaws Sharp Grasping Serrations	4 1/2" (11.5 cm)

SCANLAN®

Surgical Skin Markers

Cat. No.	Description
1001-710	Gentian Violet Regular Tip

Please check with your Scanlan Representative for Firm Sale status. Custom modifications available upon request.

For a complete listing of models visit... www.scanlaninternational.com

SPECIALTY

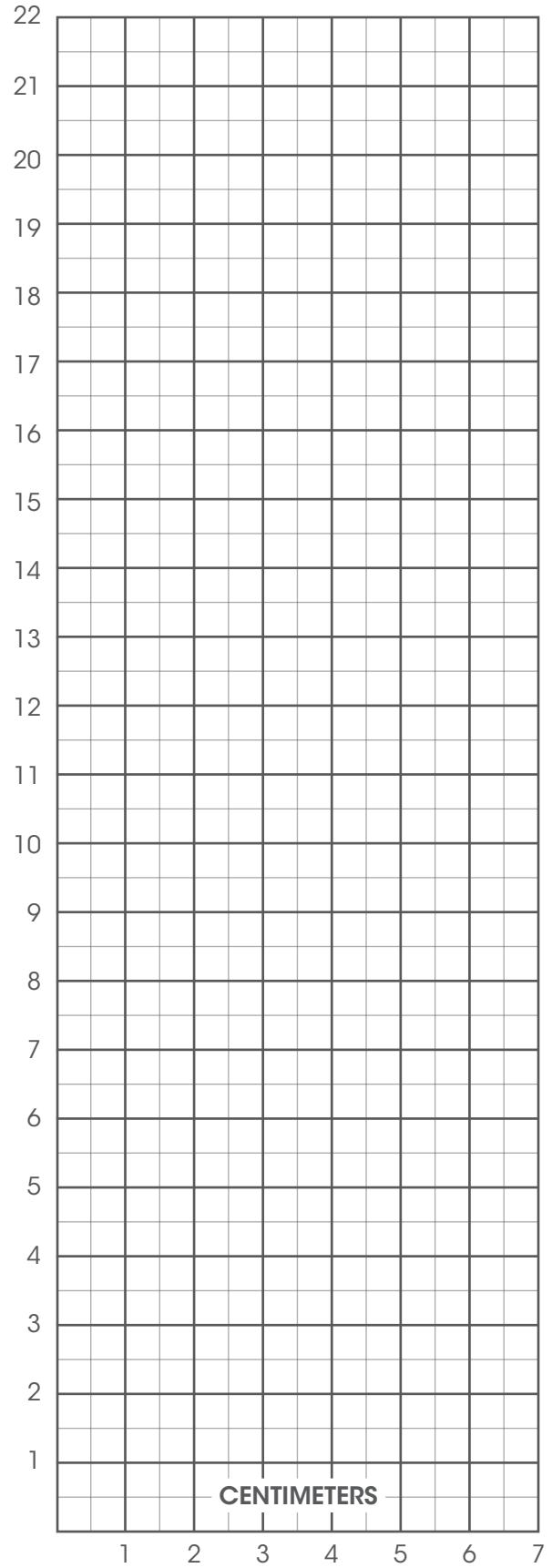
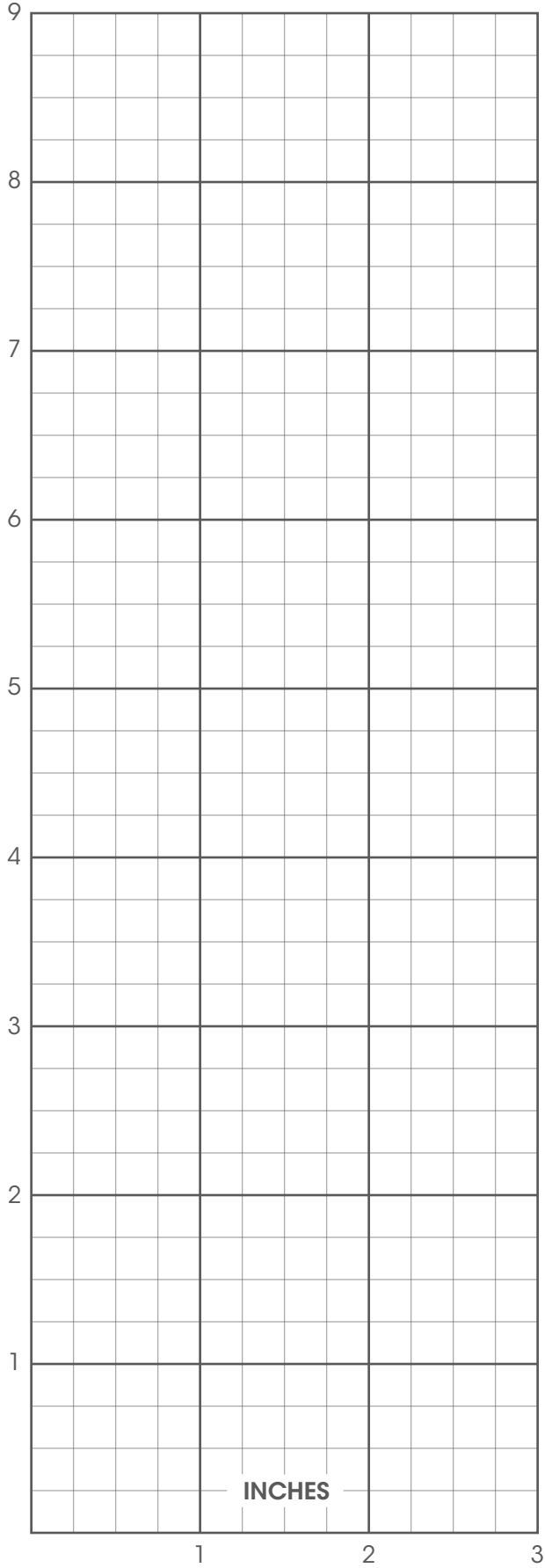



BIOPSY FORCEPS
 D'Amico Biopsy Forceps..... 7.2
 D'Amico Mediastinoscopy Biopsy Forceps..... 7.3

CLAMPS
 Rocco Nodule Clamp 7.4
 Gonzalez-Rivas Lung Grasping Clamp..... 7.5
 Foerster 7.6
 Duval 7.11
 Node Grasper 7.12
 Kahn Decortication Grasper..... 7.13
 Gonzalez-Rivas Dissector..... 7.14
 Gening J SPH Snake™ Dissector 7.15
 Dennis Dissector..... 7.16
 DeBakey Cooley Clamps 7.17
 Harken 7.18
 Allis Forceps..... 7.19
 D'Amico DeBakey Clamps..... 7.20
 Chitwood DeBakey Clamps 7.21

SCISSORS
 Super Cut™ Chitwood Handle..... 7.25

FORCEPS
 Axial Handle..... 7.27
 Rocco Adventitia Elevator 7.29
 Spring Style..... 7.29

NEEDLE HOLDERS
 Spring Style..... 7.30
 Ring Handle 7.31
 Axial Handle..... 7.35

SPECIALTY
 Gonzalez-Rivas Knot Pusher7.37
 Chitwood Knot Tier / Pusher..... 7.38
 Chitwood Suture Cutter..... 7.39
Suction Instruments
 Wolf 7.40
 Dennis..... 7.41
 D'Amico..... 7.42
 Suction Accessories7.43
 Dennis Rib Cutter7.44
 Periosteal Elevator.....7.45
 Stern™ Chest Tube Passer7.46
 Chitwood Suture Puller7.47



SCANLAN®
VATS/MIS Modifications

Modification	Description
904	Angle jaws/tips
904A	Angle and cut down jaws/tips
905	Cut down jaws/tips
905B	Cut down scissors blades
905TC	Cut down carbon inlay jaws/tips
907	Angled shanks - down
907B	Angled shanks - up
912	Blunt tips of scissors
912A	Sharpen tips of scissors
915	Gold plating
924	Tension modification
928	Modify to left-handed instrument (ring style)
928A	Modify to left-handed instrument (spring style)
929	Special etching
965	Remove ratchets on ring handle instruments
979	Add ratchet to instrument (spring style)



Example 1
 9909-926
 Modified to have Ratchets Removed



Example 2
 9909-912-13
 Modified to have Jaws Angled and
 Shanks Angled Down

Please Note...

Each Scanlan instrument is individually handcrafted to provide the surgeon with the highest quality, longest-lasting, precision instrument possible. Reflecting this unique process, all stated dimensions are approximate.



VATS/MIS Length Selections

Shorter Length

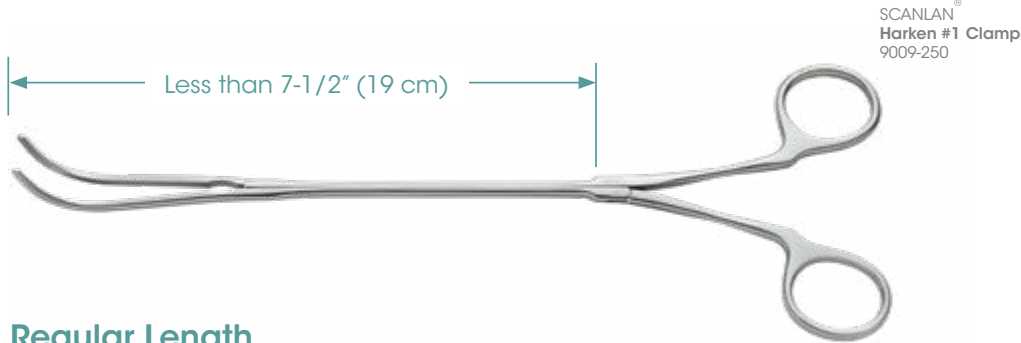

Regular Length

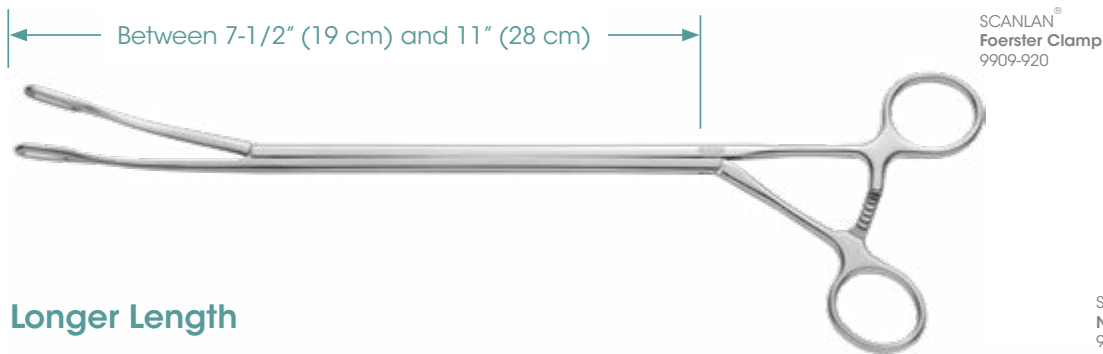

Longer Length

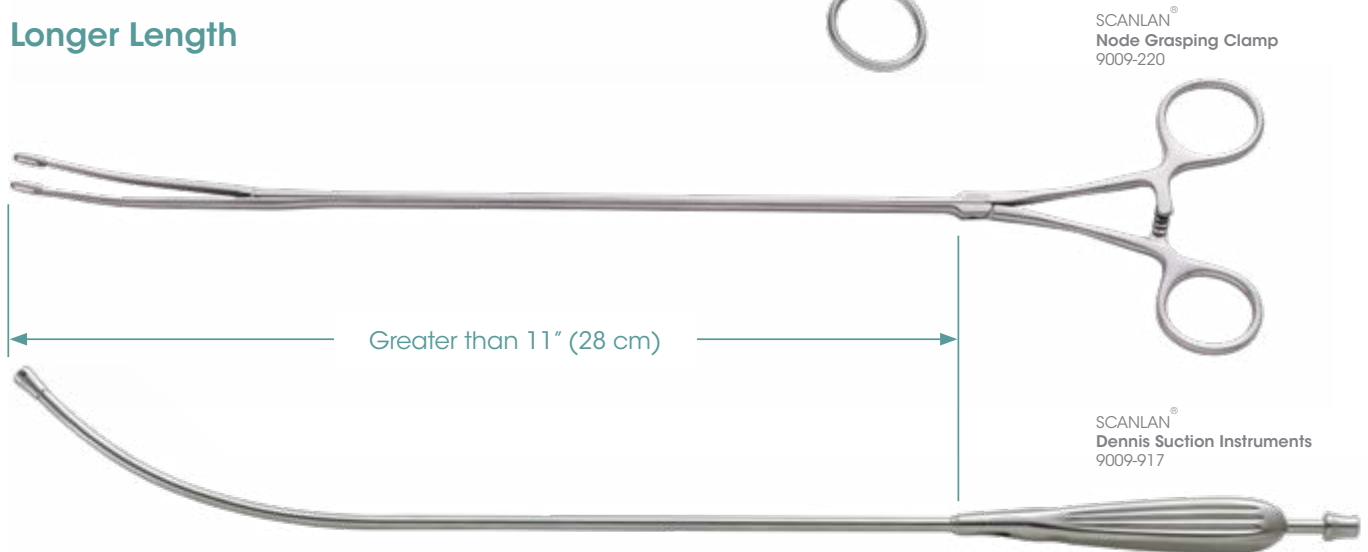

Please Note...
Each Scanlan instrument is individually handcrafted to provide the surgeon with the highest quality, longest-lasting, precision instrument possible.
Reflecting this unique process, all stated dimensions are approximate.

Please check with your Scanlan Representative for Firm Sale status. Custom modifications available upon request.
For a complete listing of models visit... www.scanlaninternational.com



VATS / MIS

9009-302

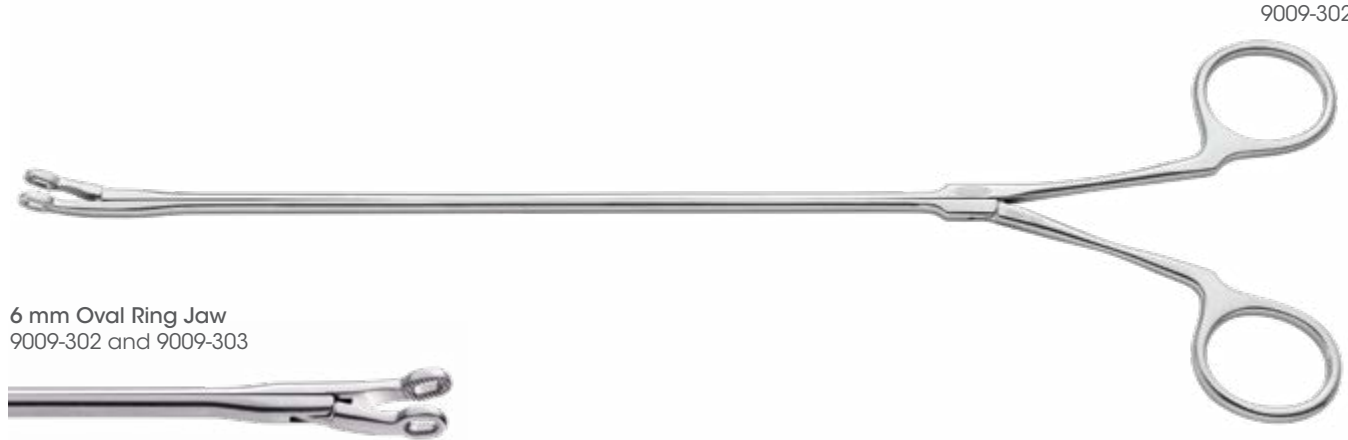

6 mm Oval Ring Jaw
9009-302 and 9009-303



7 mm Oval Cupped Jaws
9009-312 and 9009-313



VATS SCANLAN®
D'Amico Biopsy Forceps, Ring Handle, Shorter Length
Developed in cooperation with Thomas A. D'Amico, MD

Cat. No.	Description	Shaft	Working Length	Total Length
9009-302	6 mm Width Oval Ring Jaws Curved With Ratchet	5 mm Tapered to 7 mm	9" (23 cm)	13" (33 cm)
9009-303	6 mm Width Oval Ring Jaws Curved Without Ratchet			
9009-312	7 mm Width Oval Cupped Jaws Curved With Ratchet			
9009-313	7 mm Width Oval Cupped Jaws Curved Without Ratchet			

Please Note...

Each Scanlan instrument is individually handcrafted to provide the surgeon with the highest quality, longest-lasting, precision instrument possible. Reflecting this unique process, all stated dimensions are approximate.

Mediastinoscopy Forceps

9009-301

VATS / MIS



6 mm Oval Ring Jaws
9009-300 and 9009-301

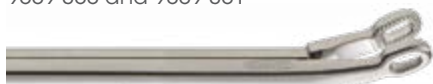

7 mm Oval Cupped Jaws
9009-310 and 9009-311

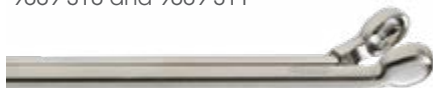

SCANLAN®
VATS **D'Amico Mediastinoscopy Forceps**
Developed in cooperation with Thomas A. D'Amico, MD

Cat. No.	Description	Shaft	Working Length	Total Length
9009-300	6 mm Width Oval Ring Jaws Curved With Ratchet	7 mm	11" (28 cm)	15" (38 cm)
9009-301	6 mm Width Oval Ring Jaws Curved Without Ratchet			
9009-310	7 mm Width Oval Cupped Jaws Curved With Ratchet			
9009-311	7 mm Width Oval Cupped Jaws Curved Without Ratchet			

Please check with your Scanlan Representative for Firm Sale status. Custom modifications available upon request.
For a complete listing of models visit... www.scanlaninternational.com



Rocco Nodule Clamp

VATS / MIS



9909-946

3.0 cm inner diameter and 3.7 cm outer diameter
9909-946



4.5 cm inner diameter and 5.2 cm outer diameter
9909-947

SCANLAN®
VATS Rocco Nodule Clamps
 Developed in cooperation with Gaetano Rocco, MD, FRCSEd, FEBTS, FCCP

Cat. No.	Description	Suggested Nodule Size*	Shaft	Working Length	Total Length
9909-946	Curved left ring jaws 3.0 cm inner diameter and 3.7 cm outer diameter with ratchet	Up to 1 cm	10 mm	9 1/2" (24 cm)	13 1/4" (33.5 cm)
9909-947	Curved left ring jaws 4.5 cm inner diameter and 5.2 cm outer diameter with ratchet	Between 1 and 1.5 cm			

*Suggested Nodule Size per Gaetano Rocco, MD, FRCSEd, FEBTS, FCCP

Please Note...

Each Scanlan instrument is individually handcrafted to provide the surgeon with the highest quality, longest-lasting, precision instrument possible. Reflecting this unique process, all stated dimensions are approximate.



Gonzalez-Rivas Lung Grasping Clamp

9009-230

VATS / MIS



9009-230

SCANLAN®
VATS Gonzalez-Rivas Lung Grasping Clamp
 Developed in cooperation with Diego Gonzalez-Rivas, MD, FECTS

Cat. No.	Description	Shaft	Working Length	Total Length
9009-230	High tension Curved left 20 mm oval ring jaws With ratchet	7 mm Tapered to 10 mm	5 3/4" (14.5 cm)	9 3/4" (24.5 cm)

Please check with your Scanlan Representative for Firm Sale status. Custom modifications available upon request.
 For a complete listing of models visit... www.scanlaninternational.com



Foerster Lung Grasping Clamp

VATS / MIS

9009-229



9009-229



9009-237

SCANLAN®
VATS Foerster Lung Grasping Clamp

Cat. No.	Description	Shaft	Working Length	Total Length
9009-229	Curved left 20 mm oval ring jaws with ratchet	5 mm Tapered to 7 mm	9 1/4" (23.5 cm)	13 1/4" (33.5 cm)
9009-237			12 1/2" (32 cm)	16 1/2" (41.9 cm)

Please Note...

Each Scanlan instrument is individually handcrafted to provide the surgeon with the highest quality, longest-lasting, precision instrument possible. Reflecting this unique process, all stated dimensions are approximate.

Please check with your Scanlan Representative for Firm Sale status. Custom modifications available upon request.

For a complete listing of models visit... www.scanlaninternational.com



Foerster Lung Grasping Clamp

9009-227

VATS / MIS



Curved Left
12 mm Oval Ring Jaws
9009-228



Curved Right
(Left-Hand Style)
12 mm Oval Ring Jaws
9009-227



Curved Left
20 mm Oval Ring Jaws
9909-922



Curved Right
20 mm Oval Ring Jaws
9909-921



SCANLAN®
VATS Foerster Lung Grasping Clamp

Cat. No.	Description	Shaft	Working Length	Total Length
9009-227	Curved Right Jaws (Left-Hand Style) 12 mm Oval Ring Jaws With Ratchet	7 mm	7 1/2" (19 cm)	11 1/2" (29 cm)
9009-228	Curved Left Jaws 12 mm Oval Ring Jaws With ratchet			
9909-921	Curved Right (Left-Hand Style) 20 mm Oval Ring Jaws With Ratchet	10 mm		
9909-922	Curved Left 20 mm Oval Ring Jaws With Ratchet			



Foerster Lung Grasping Clamp

VATS / MIS

9009-226



SCANLAN®
VATS Foerster Lung Grasping Clamp

Cat. No.	Description	Shaft	Working Length	Total Length
9009-226	Curved left jaws 12 mm oval ring jaws With ratchet	7 mm	9 1/4" (23.5 cm)	13 1/4" (33.5 cm)

Please Note...

Each Scanlan instrument is individually handcrafted to provide the surgeon with the highest quality, longest-lasting, precision instrument possible. Reflecting this unique process, all stated dimensions are approximate.

Foerster Lung Grasping Clamp

9909-923

VATS / MIS



9909-923



9909-919



VATS SCANLAN®
Foerster Lung Grasping Clamp

Cat. No.	Description	Shaft	Working Length	Total Length
9909-923	Deep curved left jaws 20 mm oval ring jaws With ratchet	10 mm	9 1/2" (24 cm)	13" (33 cm)
9909-919	Deep curved left jaws 20 mm oval ring jaws With ratchet		12 1/2" (32 cm)	16 3/4" (42.4 cm)

Please check with your Scanlan Representative for Firm Sale status. Custom modifications available upon request.
For a complete listing of models visit... www.scanlaninternational.com



Foerster Lung Grasping Clamp

VATS / MIS

9909-920



9909-920
9909-920-1



9909-925



9909-924

VATS SCANLAN®
Foerster Lung Grasping Clamp

Cat. No.	Description	Shaft	Working Length	Total Length
9909-920	Curved left jaws 20 mm oval ring jaws With ratchet	10 mm	9 1/2" (24 cm)	13 1/4" (33.5 cm)
NEW 9909-920-1	Curved left jaws 20 mm oval ring jaws Without ratchet			
9909-925	Curved left jaws 20 mm oval ring jaws With ratchet		12 1/2" (32 cm)	16 3/4" (42.4 cm)
9909-924	Curved left jaws 25 x 35 mm oval ring jaws With ratchet		9 1/2" (24 cm)	13 1/4" (33.5 cm)

Duval Lung Grasping Clamp

9909-926

VATS / MIS



9909-926
9909-928



9909-927

VATS SCANLAN®
Duval Lung Grasping Clamp

Cat. No.	Description	Shaft	Working Length	Total Length
9909-926	Curved left jaws 1.0 cm width triangular ring jaws With ratchet	10 mm	9 1/4" (23.5 cm)	13 1/2" (34 cm)
9909-928			12 1/2" (32 cm)	16 3/4" (42.4 cm)
9909-927	Curved left jaws 2.5 cm width triangular ring jaws With ratchet		9 1/4" (23.5 cm)	13 1/2" (34 cm)

Please Note...
Each Scanlan instrument is individually handcrafted to provide the surgeon with the highest quality, longest-lasting, precision instrument possible.
Reflecting this unique process, all stated dimensions are approximate.

Please check with your Scanlan Representative for Firm Sale status. Custom modifications available upon request.
For a complete listing of models visit... www.scanlaninternational.com



SCANLAN®
Node Grasping Clamp

VATS / MIS

9009-223

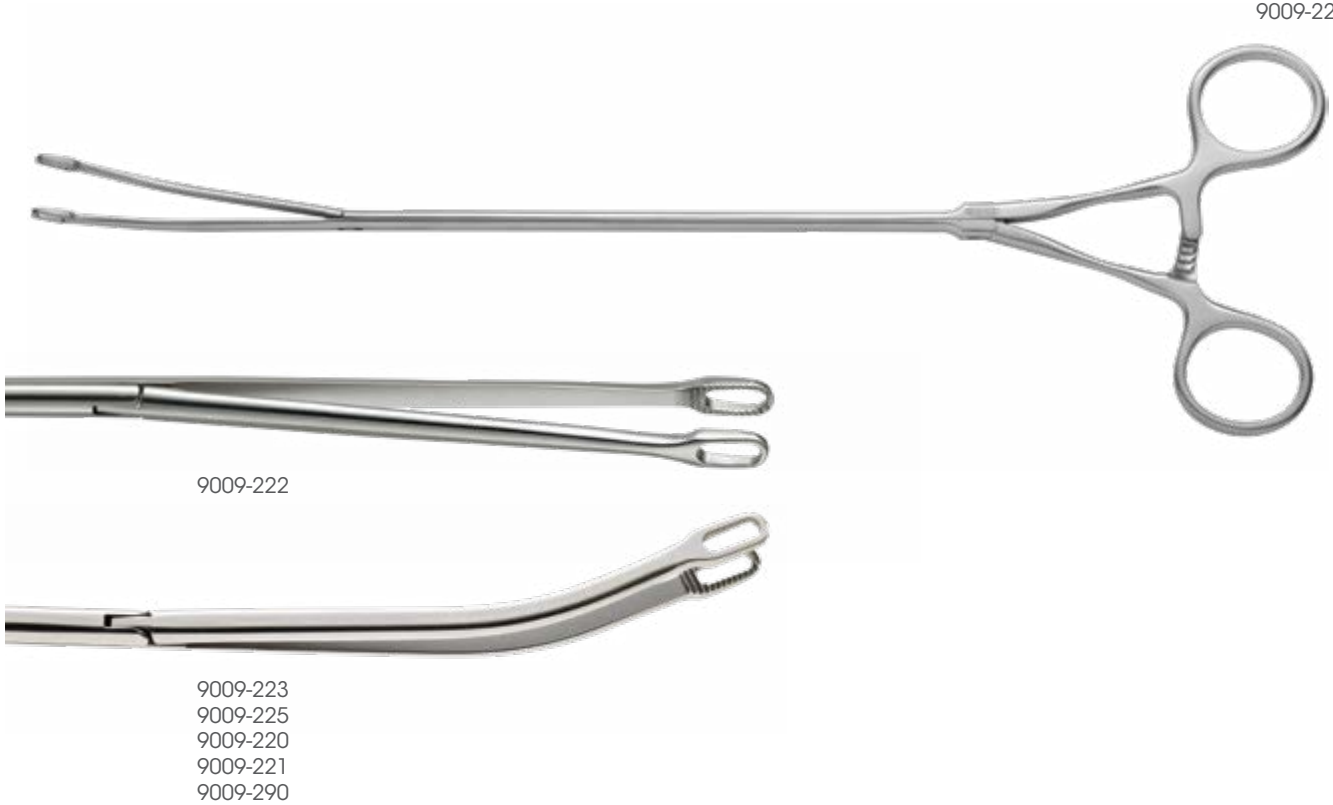

SCANLAN®
VATS Node Grasping Clamp

Cat. No.	Description	Shaft	Working Length	Total Length
9009-222	Straight jaws 11 mm oblong ring jaws With ratchet	5 mm	9" (23 cm)	13" (33 cm)
9009-223	Curved jaws 11 mm oblong ring jaws With ratchet			
9009-225	Curved jaws 11 mm oblong ring jaws Without ratchet			
NEW 9009-290	Thoroscopic Grasping Dissector Curved jaws 11 mm oblong ring jaws With ratchet <i>NOTE: Ratchets are tuned to engage after jaws meet.</i>			
9009-220	Curved jaws 11 mm oblong ring jaws With ratchet	5 mm Tapered to 7 mm	12 1/2" (32 cm)	16 3/4" (42.4 cm)
9009-221	Curved jaws 11 mm oblong ring jaws Without ratchet			

Khan Decortication Grasper

9909-940

VATS / MIS



9909-940



SCANLAN®

Khan Decortication Grasper Clamp

Developed in cooperation with Prof. Ali Zamir Khan, MS, FRCS(Glasg), FRCS(CTh), FEBTS, MBA

Cat. No.	Description	Shaft	Working Length	Total Length
9909-940	Enhanced serrations Curved left jaws With ratchet	10 mm	9 1/2" (24 cm)	13 1/4" (33.5 cm)

Kahn Decortication Grasper Jaws Compared to Foerster Clamp Jaws

9909-940
Khan Decortication Grasper



9909-920
Foerster Lung Clamp



Please Note...
Each Scanlan instrument is individually handcrafted to provide the surgeon with the highest quality, longest-lasting, precision instrument possible.
Reflecting this unique process, all stated dimensions are approximate.

Please check with your Scanlan Representative for Firm Sale status. Custom modifications available upon request.
For a complete listing of models visit... www.scanlaninternational.com



Gonzalez-Rivas Dissector

VATS / MIS

9009-211



1 x 2 DeBakey Jaws
9009-210, 9009-211, 9009-214, 9009-215, 9009-216, 9009-217



1 x 2 DeBakey Jaws Fine Tips
9009-212 and 9009-213



SCANLAN®
VATS Gonzalez-Rivas Dissector
Developed in cooperation with Diego Gonzalez-Rivas, MD, FECTS

Cat. No.	Description	Shaft	Working Length	Total Length
9009-210	Mixer-style 1 x 2 DeBakey jaws With ratchet	5 mm	7 1/2" (19 cm)	11 1/2" (29 cm)
9009-211	Mixer-style 1 x 2 DeBakey jaws Without ratchet			
9009-212	Mixer-style 1 x 2 DeBakey jaws fine tips With ratchet			
9009-213	Mixer-style 1 x 2 DeBakey jaws fine tips Without ratchet			
9009-214	Mixer-style 1 x 2 DeBakey jaws With ratchet	5 mm to 7 mm Tapered	9 1/2" (24 cm)	13 1/2" (34 cm)
9009-215	Mixer-style 1 x 2 DeBakey jaws Without ratchet			
9009-216	Mixer-style 1 x 2 DeBakey jaws With ratchet	5 mm to 7 mm Tapered	12 1/2" (32 cm)	16 1/2" (41.9 cm)
9009-217	Mixer-style 1 x 2 DeBakey jaws Without ratchet			

Gening J SPH Snake™ Dissector

9009-284

VATS / MIS



VATS SCANLAN®
Gening J SPH Snake™ Dissector
 Developed in cooperation with Gening Jiang, MD

Cat. No.	Description	Shaft	Working Length	Total Length
NEW 9009-284	Curved dissector jaws With ratchet	5 mm Tapered To 7 mm	9 1/4" (23.5 cm)	13 1/2" (34 cm)
NEW 9009-285	Curved dissector jaws Without ratchet			
NEW 9009-286	Curved dissector jaws With ratchet		12 1/2" (32 cm)	16 3/4" (42.4 cm)
NEW 9009-287	Curved dissector jaws Without ratchet			

Please Note...
 Each Scanlan instrument is individually handcrafted to provide the surgeon with the highest quality, longest-lasting, precision instrument possible.
 Reflecting this unique process, all stated dimensions are approximate.

Please check with your Scanlan Representative for Firm Sale status. Custom modifications available upon request.
 For a complete listing of models visit... www.scanlaninternational.com



Dennis Dissector

VATS / MIS

9009-280

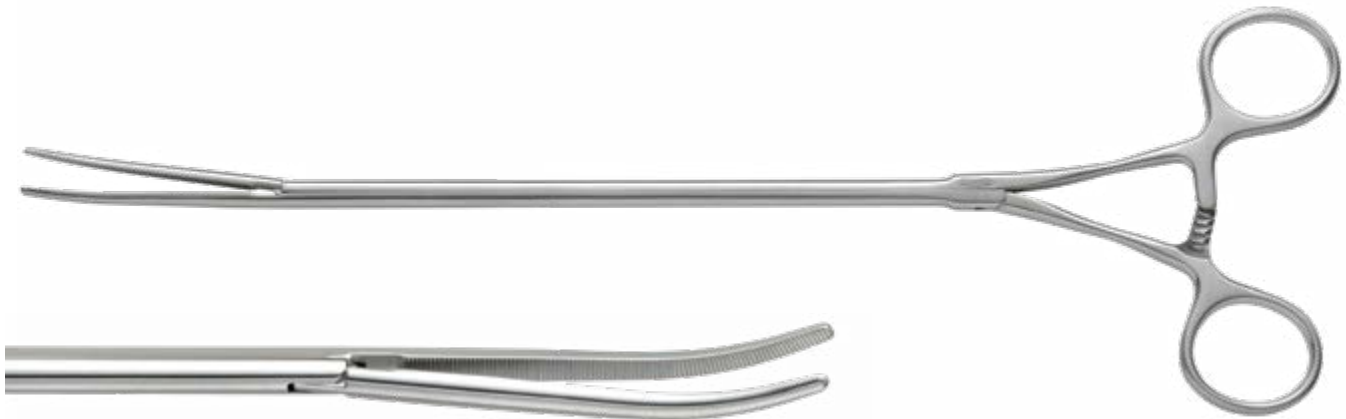

Curved Jaws
9009-280 and 9009-281



Cat. No.	Description	Shaft	Working Length	Total Length
9009-280	Curved left jaws Serrated jaws With ratchet	7 mm	9" (23 cm)	13 1/4" (33.5 cm)
9009-281	Curved left jaws Serrated jaws Without ratchet			
9009-282	Curved left jaws Serrated jaws With ratchet	5 mm Tapered To 7 mm	12.50" (32 cm)	16 3/4" (42.4 cm)
9009-283	Curved left jaws Serrated jaws Without ratchet			

Please Note...

Each Scanlan instrument is individually handcrafted to provide the surgeon with the highest quality, longest-lasting, precision instrument possible. Reflecting this unique process, all stated dimensions are approximate.

DeBakey Cooley Clamps

9909-203

VATS / MIS



90° Angled Jaws
9909-202 and 9909-203

VATS MIS SCANLAN®
DeBakey Cooley Clamps

Cat. No.	Description	Shaft	Working Length	Total Length
9909-202	DeBakey Cooley Jaws With Ratchet	10 mm	9 1/2" (24 cm)	13 1/2" (34 cm)
9909-203	DeBakey Cooley Jaws Without Ratchet			

Please check with your Scanlan Representative for Firm Sale status. Custom modifications available upon request.
For a complete listing of models visit... www.scanlaninternational.com



Harken Clamps

VATS / MIS

9909-224

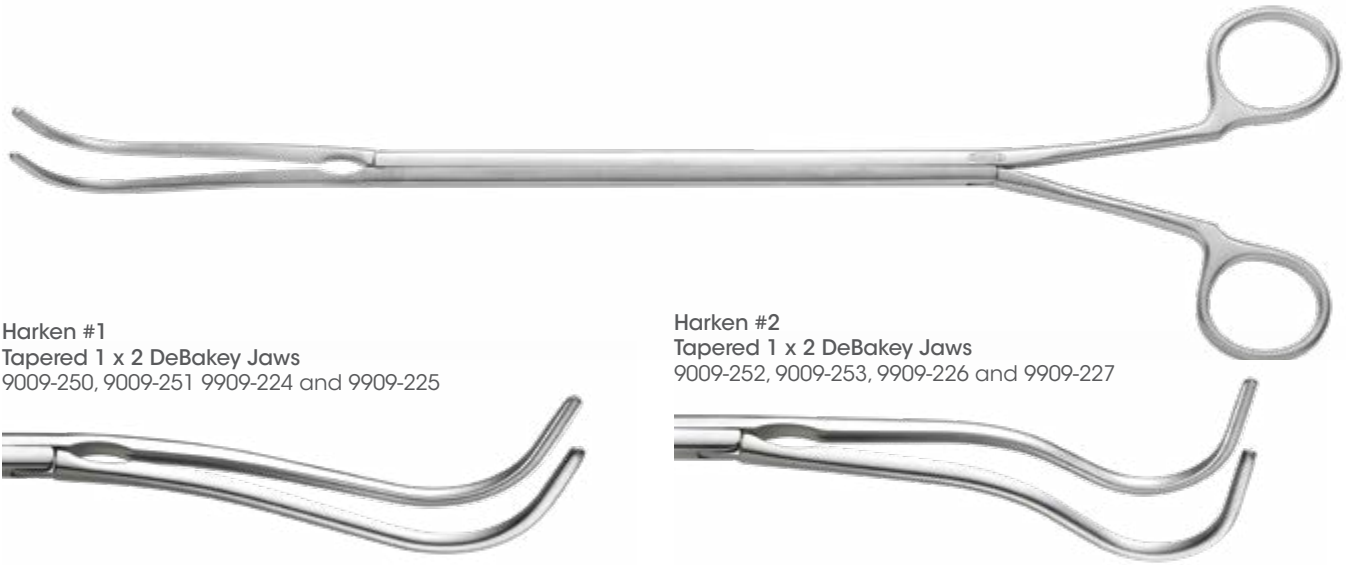

Harken #1
Tapered 1 x 2 DeBakey Jaws
9009-250, 9009-251 9909-224 and 9909-225

Harken #2
Tapered 1 x 2 DeBakey Jaws
9009-252, 9009-253, 9909-226 and 9909-227



Cat. No.	Description	Shaft	Working Length	Total Length
9009-250	7.5 cm jaws Tapered 1x2 DeBakey jaws Without ratchet	5 mm to 7 mm tapered	7 1/2" (19 cm)	11 1/2" (29 cm)
9009-251	7.5 cm jaws Tapered 1x2 DeBakey jaws With ratchet			
9009-252	7.5 cm jaws Tapered 1x2 DeBakey jaws Without ratchet			
9009-253	7.5 cm jaws Tapered 1x2 DeBakey jaws With ratchet			
9909-224	9.5 cm jaws Tapered 1x2 DeBakey jaws Without ratchet	10 mm	9 7/8" (25 cm)	14" (35.6 cm)
9909-225	9.5 cm jaws Tapered 1x2 DeBakey jaws With ratchet			
9909-226	9.5 cm jaws Tapered 1x2 DeBakey jaws Without ratchet			
9909-227	9.5 cm jaws Tapered 1x2 DeBakey jaws With ratchet			

Allis Forceps (Clamp)

9009-270

VATS / MIS



9009-270

9009-274
9009-275



SCANLAN®
Allis Forceps

Cat. No.	Description	Shaft	Working Length	Total Length
9009-270	Curved left jaws 6 mm width jaws With ratchet	7 mm	9" (23 cm)	13 1/4" (33.5 cm)
9009-274	Straight jaws 4 mm width jaws With ratchet	5 mm Tapered to 7 mm	7 1/2" (19 cm)	11 1/2" (29 cm)
9009-275	Curved left jaws 4 mm width jaws With ratchet			

Please Note...
Each Scanlan instrument is individually handcrafted to provide the surgeon with the highest quality, longest-lasting, precision instrument possible.
Reflecting this unique process, all stated dimensions are approximate.

Please check with your Scanlan Representative for Firm Sale status. Custom modifications available upon request.
For a complete listing of models visit... www.scanlaninternational.com



D'Amico DeBakey Clamps

VATS / MIS

9909-221



Curved 1 x 2 Tapered DeBakey Jaws
9909-219 and 9909-221



D'Amico Tapered Jaw Tip
Compared to
Chitwood DeBakey Jaw Tip

9909-219 and 9909-221
D'Amico curved tapered
1 x 2 DeBakey jaws



Straight 1 x 2 Tapered DeBakey Jaws
9909-222



9909-912-13
Chitwood curved
1 x 2 DeBakey jaws



SCANLAN®
VATS **D'Amico DeBakey Clamps**
Developed in cooperation with Thomas A. D'Amico, MD

Cat. No.	Description	Shaft	Working Length	Total Length
9909-219	Curved left jaws Tapered 1x2 DeBakey jaws 11cm jaw length Without ratchet	10 mm	10" (25.4 cm)	14 1/2" (37 cm)
9909-221	Curved left jaws Tapered 1x2 DeBakey jaws 11cm jaw length With ratchet			
9909-222	Straight jaws Tapered 1x2 DeBakey jaws 11.5 cm jaw length With ratchet		10 1/2" (27 cm)	14 3/4" (37.5 cm)

Please Note...

Each Scanlan instrument is individually handcrafted to provide the surgeon with the highest quality, longest-lasting, precision instrument possible. Reflecting this unique process, all stated dimensions are approximate.



Chitwood DeBakey Clamps

9009-240

VATS / MIS



1 x 2 DeBakey Jaws
9009-240 and 9009-241

VATS **MIS** **SCANLAN®**
Chitwood DeBakey Clamps
 Developed in cooperation with W. Randolph Chitwood Jr., MD

Cat. No.	Description	Shaft	Working Length	Total Length
9009-240	6 cm jaw length Curved left jaws 1 x 2 DeBakey jaws With ratchet	5 mm	8 1/4" (21 cm)	12 1/4" (31 cm)
9009-241	6 cm jaw length Curved left jaws 1 x 2 DeBakey jaws Without ratchet			

Please check with your Scanlan Representative for Firm Sale status. Custom modifications available upon request.
 For a complete listing of models visit... www.scanlaninternational.com



Chitwood DeBakey Clamps

VATS / MIS

9909-912-13



1 x 2 DeBakey Jaws
9909-912



1 x 2 DeBakey Jaws
9909-912-13



2 x 3 DeBakey Jaws
9909-232



VATS
MIS
SCANLAN®
Chitwood DeBakey Clamps
 Developed in cooperation with W. Randolph Chitwood Jr., MD

Cat. No.	Description	Shaft	Working Length	Total Length
9909-912	6.5 cm jaw length 1x2 DeBakey jaws Curved left jaws With ratchet	10 mm	9" (23 cm)	12 3/4" (32.5 cm)
9909-912-13	10 cm jaw length 1x2 DeBakey jaws Curved left jaws With ratchet		10" (25.4 cm)	14 1/4" (36 cm)
9909-232	10 cm jaw length 2x3 DeBakey jaws Curved left jaws With ratchet			

Please Note...

Each Scanlan instrument is individually handcrafted to provide the surgeon with the highest quality, longest-lasting, precision instrument possible. Reflecting this unique process, all stated dimensions are approximate.



Chitwood DeBakey Clamps

9909-914

VATS / MIS



1 x 2 DeBakey Jaws
9909-915



1 x 2 DeBakey Jaws
9909-914



VATS
MIS
SCANLAN®
Chitwood DeBakey Clamps
 Developed in cooperation with W. Randolph Chitwood Jr., MD

Cat. No.	Description	Shaft	Working Length	Total Length
9909-914	7 cm jaw length Curved left jaw 1x2 DeBakey jaws With ratchet	10 mm	6 3/4" (17 cm)	10 3/8" (26.4 cm)
9909-915	7 cm jaw length Curved right jaw 1x2 DeBakey jaws With ratchet			

Please check with your Scanlan Representative for Firm Sale status. Custom modifications available upon request.
For a complete listing of models visit... www.scanlaninternational.com



Chitwood DeBakey Clamps

VATS / MIS

9909-234



2 x 3 DeBakey Jaws
9909-234

MIS SCANLAN®
Chitwood DeBakey Clamps
Developed in cooperation with W. Randolph Chitwood Jr., MD

Cat. No.	Description	Shaft	Working Length	Total Length
9909-234	8 cm jaw length Curved left jaws 2 x 3 DeBakey jaws Angled shanks	10 mm	5 1/8" (13 cm)	8" (20.5 cm)

9909-913



MIS SCANLAN®
Chitwood DeBakey Clamps
Developed in cooperation with W. Randolph Chitwood Jr., MD

Cat. No.	Description	Shaft	Working Length	Total Length
9909-913	7 cm jaw length Curved left jaws 1 x 2 DeBakey jaws Angled shanks	10 mm	6 3/4" (17 cm)	9 3/4" (24.8 cm)

9009-738SC

VATS / MIS

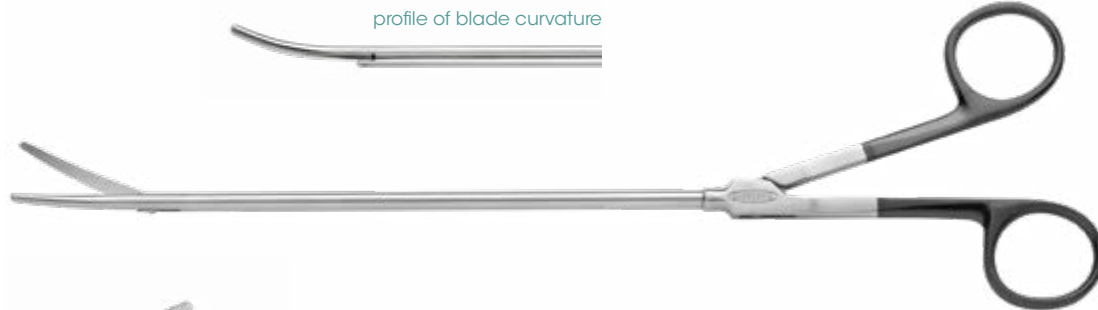

Straight Fine Blades
9009-716SC



Curved Blades
9009-718SC



Curved Blades
9009-738SC



VATS
MIS
SCANLAN®
Chitwood Dissecting Scissors
 Developed in cooperation with W. Randolph Chitwood Jr., MD

Cat. No.	Description	Shaft	Working Length	Total Length
9009-716SC	Straight fine blades 1 cm blade length Blunt micro tips	5 mm	6 1/2" (16.5 cm)	10 1/2" (27 cm)
9009-718SC	Curved Fine Blades 1 cm Blade Length Blunt Micro Tips		6 1/2" (16.5 cm)	10 1/2" (27 cm)
9009-738SC	Chitwood dissecting scissors Curved blades 3 cm blade length Blunt tips		7 1/4" (18.5 cm)	11 1/2" (29 cm)

Please Note...
 Each Scanlan instrument is individually handcrafted to provide the surgeon with the highest quality, longest-lasting, precision instrument possible.
 Reflecting this unique process, all stated dimensions are approximate.

Please check with your Scanlan Representative for Firm Sale status. Custom modifications available upon request.
 For a complete listing of models visit... www.scanlaninternational.com



Super Cut™ Scissors

VATS / MIS

9009-710SC



VATS **MIS** SCANLAN®
Metzenbaum Scissors

Cat. No.	Description	Shaft	Working Length	Total Length
9009-710SC	Curved blades 3.1 cm blade length Blunt tips	8 mm	12 1/2" (32 cm)	16 1/2" (42.1 cm)

9909-911SC

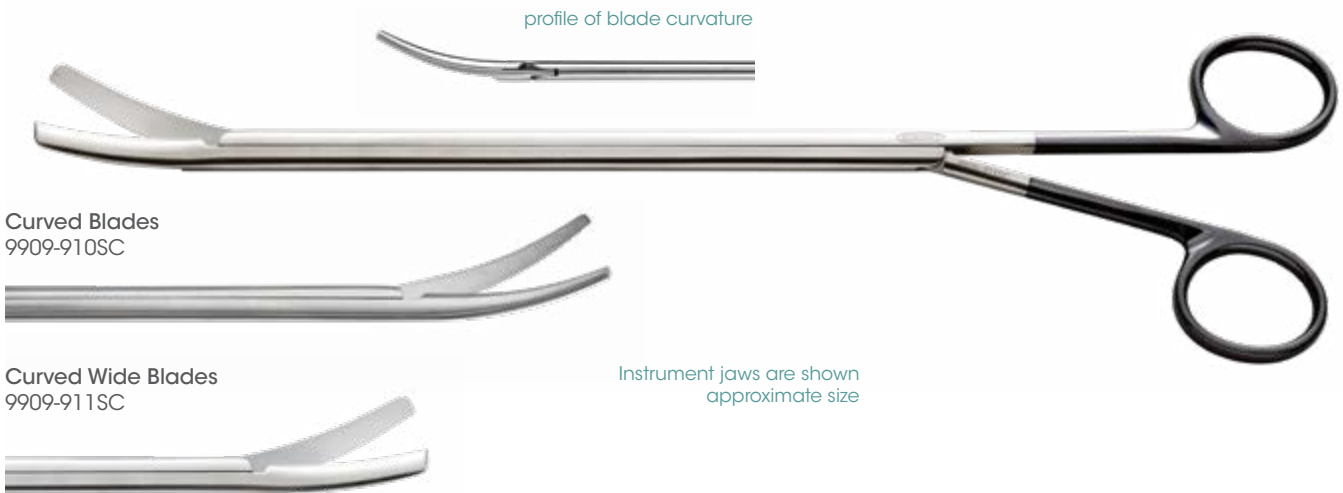

Curved Blades
9909-910SC

Curved Wide Blades
9909-911SC

Instrument jaws are shown
approximate size

VATS SCANLAN®
Metzenbaum Scissors

Cat. No.	Description	Shaft	Working Length	Total Length
9909-910SC	Curved blades 3.5 cm blade length Blunt tips	10 mm	7 3/4" (19.5 cm)	11 1/2" (29 cm)
9909-911SC	Curved wide blades 3.5 cm blade length Blunt tips			

Please Note...

Each Scanlan instrument is individually handcrafted to provide the surgeon with the highest quality, longest-lasting, precision instrument possible. Reflecting this unique process, all stated dimensions are approximate.

Gonzalez-Rivas Forceps

9009-530

VATS / MIS



Curved DeBakey Jaws, 2.5 mm Width
9009-530

VATS SCANLAN®
Gonzalez-Rivas Forceps
Developed in cooperation with Diego Gonzalez-Rivas, MD, FECTS

Cat. No.	Description	Shaft	Working Length	Total Length
9009-530	8 mm diamond knurling 2.5 mm width curved DeBakey jaws without ratchet	5 mm	6 3/8" (16.2 cm)	12 3/4" (32.5 cm)
9009-532			8" (20 cm)	14-3/8" (36.5 cm)

Axial Handle Forceps

9009-528

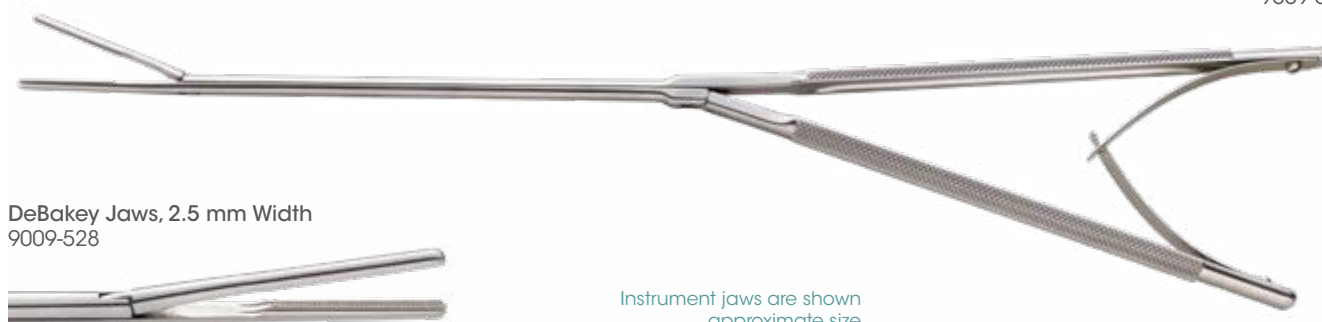

DeBakey Jaws, 2.5 mm Width
9009-528

Instrument jaws are shown
approximate size

VATS **MIS** SCANLAN®
Axial Handle Forceps
Round Handle | 8 mm Diameter Knurling

Cat. No.	Description	Shaft	Working Length	Total Length
9009-528	2.5 mm width DeBakey jaws Without ratchet	5 mm	6 1/4" (16 cm)	12 1/2" (32 cm)

Please check with your Scanlan Representative for Firm Sale status. Custom modifications available upon request.
For a complete listing of models visit... www.scanlaninternational.com



Axial Handle Forceps

VATS / MIS

9009-524



Resano Jaws, 2.5 mm Width
9009-510 and 9009-511



Russian Jaws, 6 mm Width
9009-512 and 9009-513



Platform DIAMOND DUST™, 2 mm Width
9009-516 and 9009-517



DeBakey Jaws, 1.5 mm Width
9009-520 and 9009-521



DeBakey Jaws, 2.5 mm Width
9009-522 and 9009-523



DeBakey Jaws, 3.5 mm Width
9009-524 and 9009-525



VATS
MIS
SCANLAN®
Axial Handle Forceps
 Round Handle | 10 mm Diameter Knurling

Cat. No.	Description	Shaft	Working Length	Total Length
9009-510	2.5 mm width Resano jaws Without ratchet	5 mm	8" (20 cm)	14 1/4" (36 cm)
9009-511	2.5 mm width Resano jaws With ratchet			
9009-512	6 mm width Russian jaws Without ratchet			
9009-513	6 mm width Russian jaws With ratchet			
9009-516	2 mm width Platform DIAMOND DUST™ jaws Without ratchet			
9009-517	2 mm width Platform DIAMOND DUST™ jaws With ratchet			
9009-520	1.5 mm width DeBakey jaws Without ratchet			
9009-521	1.5 mm width DeBakey jaws With ratchet			
9009-522	2.5 mm width DeBakey jaws Without ratchet			
9009-523	2.5 mm width DeBakey jaws With ratchet			
9009-524	3.5 mm width DeBakey jaws Without ratchet			
9009-525	3.5 mm width DeBakey jaws With ratchet			

Please Note...

Each Scanlan instrument is individually handcrafted to provide the surgeon with the highest quality, longest-lasting, precision instrument possible. Reflecting this unique process, all stated dimensions are approximate.



Rocco Adventitia Elevator (Forceps)

9009-500

VATS / MIS



9009-500



SCANLAN®
VATS **Rocco Adventitia Elevator (Forceps)**
 Developed in cooperation with Gaetano Rocco, MD, FRCsed, FETCS, FCCP

Cat. No.	Description	Shaft	Working Length	Total Length
9009-500	DIAMOND DUST™ Jaws Curved Down Without Ratchet Ring Handle Curved Down	5 mm	8" (20 cm)	12 3/4" (32.5 cm)

SCANLAN®

Spring Style Forceps

9009-422



DeBakey Jaws, 1 mm Width
9009-420

DeBakey Jaws, 2 mm Width
9009-422



SCANLAN®
VATS **MIS** **Jacobson Spring Style Forceps**
 Round Handle | 8 mm Diameter Knurling

Cat. No.	Description	Shaft	Working Length	Total Length
9009-420	1 mm width straight DeBakey jaws Without ratchet	5 mm	7 3/4" (19.5 cm)	16" (41 cm)
9009-422	2 mm width straight DeBakey jaws Without ratchet			

Please check with your Scanlan Representative for Firm Sale status. Custom modifications available upon request.
 For a complete listing of models visit... www.scanlaninternational.com



Spring Style Needle Holders

VATS / MIS

9009-648



Straight DIAMOND DUST™ Jaws,
for 5-0 Suture
9009-648

Curved DIAMOND DUST™ Jaws,
for 5-0 Suture
9009-650



Instrument jaws are shown
approximate size



SCANLAN®

Jacobson Spring Style Needle Holders

Round Handle | 8 mm Diameter Knurling

Cat. No.	Description	Suture Size	Shaft	Working Length	Total Length
9009-648	Straight DIAMOND DUST™ Jaws With Ratchet	5-0 and Smaller	5 mm	6 1/2" (16.5 cm)	15 3/8" (38.5 cm)
9009-650	Curved DIAMOND DUST™ Jaws With Ratchet				

Please Note...

Each Scanlan instrument is individually handcrafted to provide the surgeon with the highest quality, longest-lasting, precision instrument possible. Reflecting this unique process, all stated dimensions are approximate.



Ring Handle Needle Holders

9009-618

VATS / MIS

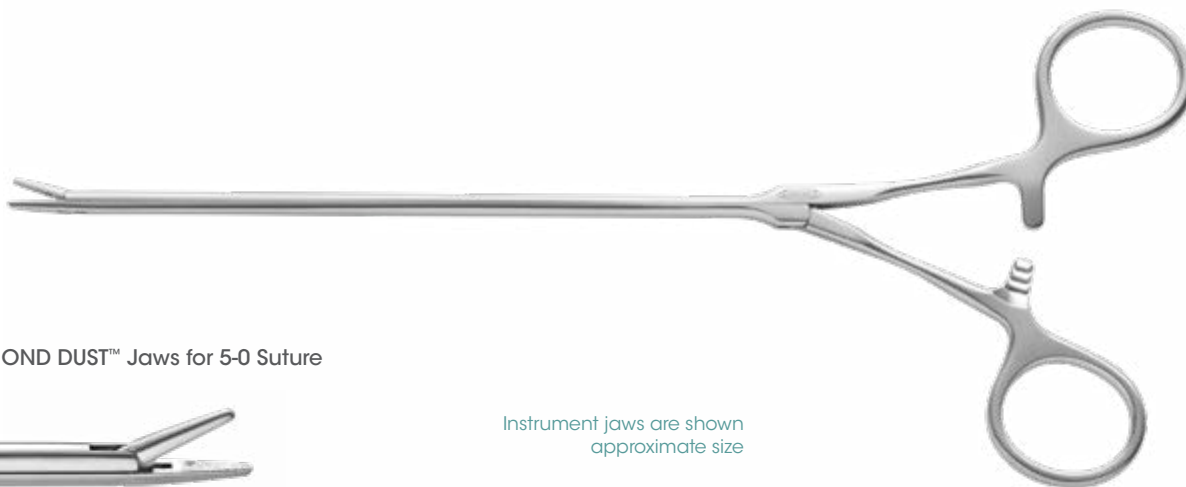

Straight DIAMOND DUST™ Jaws for 5-0 Suture
9009-618



Instrument jaws are shown
approximate size

VATS MIS SCANLAN®
Ring Handle Needle Holders

Cat. No.	Description	Suture Size	Shaft	Working Length	Total Length
9009-618	Straight jaws Fine DIAMOND DUST™ jaws With ratchet	5-0 and Smaller	5 mm	6 1/2" (16.5 cm)	10 1/2" (27 cm)

Please check with your Scanlan Representative for Firm Sale status. Custom modifications available upon request.
For a complete listing of models visit... www.scanlaninternational.com



Ring Handle Needle Holders

VATS / MIS

9009-638



Straight Carbon-Inlay Jaws for 4-0 Suture
9009-636



Curved Carbon-Inlay Jaws for 4-0 Suture
9009-637



Straight Carbon-Inlay Jaws for 2-0 Suture
9009-638



Curved Carbon-Inlay Jaws for 2-0 Suture
9009-639



Instrument jaws are shown approximate size



SCANLAN®
Ring Handle Needle Holders

Cat. No.	Description	Suture Size	Shaft	Working Length	Total Length
9009-636	Straight jaws Carbon-inlay jaws Gold ring handle With ratchet	4-0 and Smaller	7 mm	6 1/4" (16 cm)	11 1/4" (28.5 cm)
9009-637	Curved jaws Carbon-inlay jaws Gold ring handle With ratchet				
9009-638	Straight jaws Carbon-inlay jaws Gold ring handle With ratchet	2-0 and Smaller	7 mm	6 1/4" (16 cm)	11 1/4" (28.5 cm)
9009-639	Curved jaws Carbon-inlay jaws Gold ring handle With ratchet				

Please Note...

Each Scanlan instrument is individually handcrafted to provide the surgeon with the highest quality, longest-lasting, precision instrument possible. Reflecting this unique process, all stated dimensions are approximate.

Please check with your Scanlan Representative for Firm Sale status. Custom modifications available upon request.

For a complete listing of models visit... www.scanlaninternational.com



Ring Handle Needle Holders



Straight Carbon-Inlay Jaws for 2-0 Suture
9009-644

Curved Carbon-Inlay Jaws for 2-0 Suture
9009-645

VATS MIS SCANLAN®
Ring Handle Needle Holders

Cat. No.	Description	Suture Size	Shaft	Working Length	Total Length
9009-644	Straight jaws Carbon-inlay jaws Gold ring handle With ratchet	2-0 and Smaller	7 mm	12 1/2" (32 cm)	17 1/2" (44.5 cm)
9009-645	Curved jaws Carbon-inlay jaws Gold ring handle With ratchet				



Straight Carbon-Inlay Jaws for 4-0 Suture
9009-640

Curved Carbon-Inlay Jaws for 4-0 Suture
9009-642

VATS MIS SCANLAN®
Ring Handle Needle Holders

Cat. No.	Description	Suture Size	Shaft	Working Length	Total Length
9009-640	Straight jaws Carbon-inlay jaws Gold ring handle With ratchet	4-0 and Smaller	7 mm	8 1/2" (21.5 cm)	13 1/2" (34 cm)
9009-642	Curved jaws Carbon-inlay jaws Gold ring handle With ratchet				



Ring Handle Needle Holders

VATS / MIS

9909-610

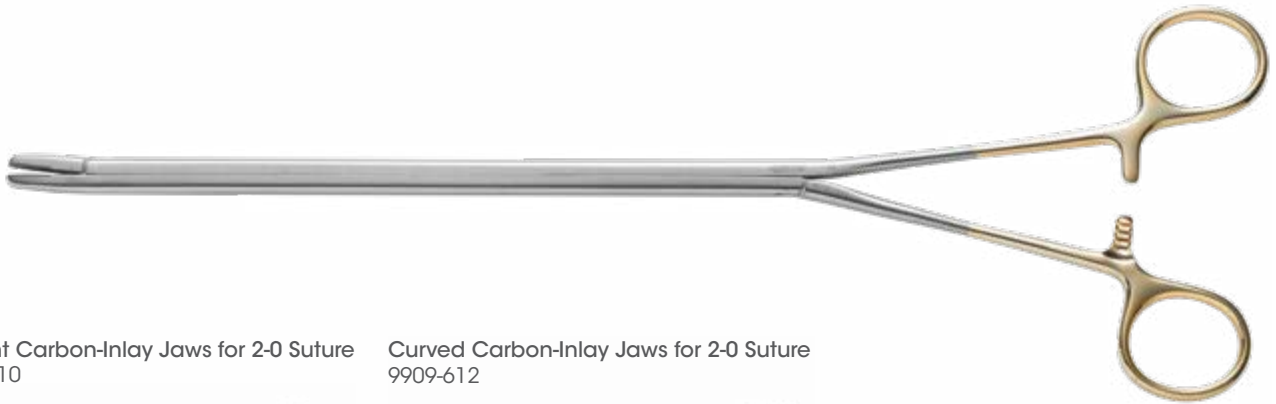

Straight Carbon-Inlay Jaws for 2-0 Suture
9909-610

Curved Carbon-Inlay Jaws for 2-0 Suture
9909-612



VATS **MIS** SCANLAN®
Ring Handle Needle Holders

Cat. No.	Description	Suture Size	Shaft	Working Length	Total Length
9909-610	Straight jaws Carbon-inlay jaws Gold ring handle With ratchet	2-0 and Smaller	10 mm	8 1/4" (21 cm)	13 1/2" (34 cm)
9909-612	Curved jaws Carbon-inlay jaws Gold ring handle With ratchet				

Please Note...

Each Scanlan instrument is individually handcrafted to provide the surgeon with the highest quality, longest-lasting, precision instrument possible. Reflecting this unique process, all stated dimensions are approximate.

Axial Handle Needle Holders

9009-541

VATS / MIS



Straight DIAMOND DUST™
Jaws, for 7-0 Suture
9009-540 and 9009-541

Curved DIAMOND DUST™
Jaws, for 7-0 Suture
9009-542 and 9009-543

Straight DIAMOND DUST™
Jaws, for 5-0 Suture
9009-550 and 9009-551

Curved DIAMOND DUST™
Jaws, for 5-0 Suture
9009-552 and 9009-553



SCANLAN®
Axial Handle Needle Holders

Cat. No.	Description	Suture Size	Shaft	Working Length	Total Length
9009-540	Straight DIAMOND DUST™ Jaws Without ratchet	7-0 and Smaller	5 mm	8" (20 cm)	14 3/8" (36.5 cm)
9009-541	Straight DIAMOND DUST™ Jaws With ratchet				
9009-542	Curved DIAMOND DUST™ Jaws Without ratchet				
9009-543	Curved DIAMOND DUST™ Jaws With ratchet				
9009-550	Straight DIAMOND DUST™ Jaws Without ratchet	5-0 and Smaller	6 mm	8" (20 cm)	14 3/8" (36.5 cm)
9009-551	Straight DIAMOND DUST™ Jaws With ratchet				
9009-552	Curved DIAMOND DUST™ Jaws Without ratchet				
9009-553	Curved DIAMOND DUST™ Jaws With ratchet				

Please check with your Scanlan Representative for Firm Sale status. Custom modifications available upon request.
For a complete listing of models visit... www.scanlaninternational.com



Axial Handle Needle Holders

VATS / MIS

9009-571



Straight Carbon-Inlay Jaws,
for 2-0 Suture
9009-570 and 9009-571

Curved Carbon-Inlay Jaws,
for 2-0 Suture
9009-572 and 9009-573

Straight Carbon-Inlay Jaws,
for 4-0 Suture
9009-560 and 9009-561

Curved Carbon-Inlay Jaws,
for 4-0 Suture
9009-562 and 9009-563



SCANLAN®

Axial Handle Needle Holders

Cat. No.	Description	Suture Size	Shaft	Working Length	Total Length
9009-570	Straight Carbon-inlay jaws Gold tipped handle Without ratchet	2-0 and Smaller	7 mm	8" (20 cm)	14 3/8" (36.5 cm)
9009-571	Straight Carbon-inlay jaws Gold tipped handle With ratchet				
9009-572	Curved Carbon-inlay jaws Gold tipped handle Without ratchet				
9009-573	Curved Carbon-inlay jaws Gold tipped handle With ratchet				
9009-560	Straight Carbon-inlay jaws Gold tipped handle Without ratchet	4-0 and Smaller	7 mm	8" (20 cm)	14 3/8" (36.5 cm)
9009-561	Straight Carbon-inlay jaws Gold tipped handle With ratchet				
9009-562	Curved Carbon-inlay jaws Gold tipped handle Without ratchet				
9009-563	Curved Carbon-inlay jaws Gold tipped handle With ratchet				



VATS SCANLAN®
Gonzalez-Rivas Knot Pusher
 Developed in cooperation with Diego Gonzalez-Rivas, MD, FECTS

Cat. No.	Description	Shaft	Working Length	Total Length
NEW 9009-826-14	Curved U-tip	5 mm	10 1/2" (27 cm)	14 3/4" (37.5 cm)
NEW 9009-826-17			12 1/2" (32 cm)	16 3/4" (42.4 cm)

Please Note...
 Each Scanlan instrument is individually handcrafted to provide the surgeon with the highest quality, longest-lasting, precision instrument possible.
 Reflecting this unique process, all stated dimensions are approximate.

Please check with your Scanlan Representative for Firm Sale status. Custom modifications available upon request.
 For a complete listing of models visit... www.scanlaninternational.com



Knot Pushers

VATS / MIS

9009-827-11



MIS SCANLAN®
Chitwood Knot Pusher Mini "Trap Model"
 Developed in cooperation with W. Randolph Chitwood Jr. MDS

Cat. No.	Description	Suture Size	Shaft	Working Length	Total Length
9009-827-11	"Trap Model"	2-0 and Smaller	5 mm	5 1/8" (13 cm)	11" (28 cm)
9009-827-12				5 1/2" (14 cm)	12" (30.5 cm)
9009-827-13				6 3/4" (17 cm)	13 5/8" (34.6 cm)
9009-827-15				8 1/2" (21.5 cm)	15 3/8" (39.1 cm)

9009-828



VATS **MIS** SCANLAN®
Chitwood Knot Pusher Original "Trap Model"
 Developed in cooperation with W. Randolph Chitwood Jr. MD

Cat. No.	Description	Suture Size	Shaft	Working Length	Total Length
9009-828	Original "Trap Model"	2-0 and Smaller	5 mm	6 1/8" (15.5 cm)	12 1/2" (32 cm)
9009-828-15	Original "Trap Model"			8 1/2" (21.5 cm)	15 3/8" (39.1 cm)
9009-828-16	Original "Trap Model" Long Handle			7 1/4" (18.5 cm)	15 3/4" (40 cm)

9009-838SC

VATS / MIS



VATS **MIS** SCANLAN®
Chitwood Super Cut™ Suture Cutter
Developed in cooperation with W. Randolph Chitwood Jr. MD

Cat. No.	Description	Suture Size	Shaft	Working Length	Total Length
9009-838SC				7" (18 cm)	11" (28 cm)
9009-840SC	"Trap Model"	2-0 and Smaller	5 mm	9" (23 cm)	13" (33 cm)
9009-842SC				11" (28 cm)	15" (38 cm)

Please Note...
Each Scanlan instrument is individually handcrafted to provide the surgeon with the highest quality, longest-lasting, precision instrument possible.
Reflecting this unique process, all stated dimensions are approximate.

Please check with your Scanlan Representative for Firm Sale status. Custom modifications available upon request.
For a complete listing of models visit... www.scanlaninternational.com





Variable Suction Regulator
9009-909 and 9009-911



6 mm Tip Diameter
All Models



Suction tips are shown
approximate size



SCANLAN®

Wolf Suction Instrument

Developed in cooperation with Randall K. Wolf, MD

Cat. No.	Description	Shaft	Working Length	Total Length
9009-908	Curved blunt tip 6 mm width tip	3.2 mm	6 3/4" (17 cm)	12 1/4" (31 cm)
9009-909	Variable suction Curved blunt tip 6 mm width tip			
9009-910	Curved blunt tip 6 mm width tip		8 3/4" (22 cm)	14 1/4" (36 cm)
9009-911	Variable suction Curved blunt tip 6 mm width tip			
9009-912	Curved blunt tip 6 mm width tip	3.2 mm to 5 mm	8 3/4" (22 cm)	14 1/4" (36 cm)
9009-913	Variable suction Curved blunt tip 6 mm width tip			

Please Note...

Each Scanlan instrument is individually handcrafted to provide the surgeon with the highest quality, longest-lasting, precision instrument possible. Reflecting this unique process, all stated dimensions are approximate.

Suction Instruments

9009-916

VATS / MIS

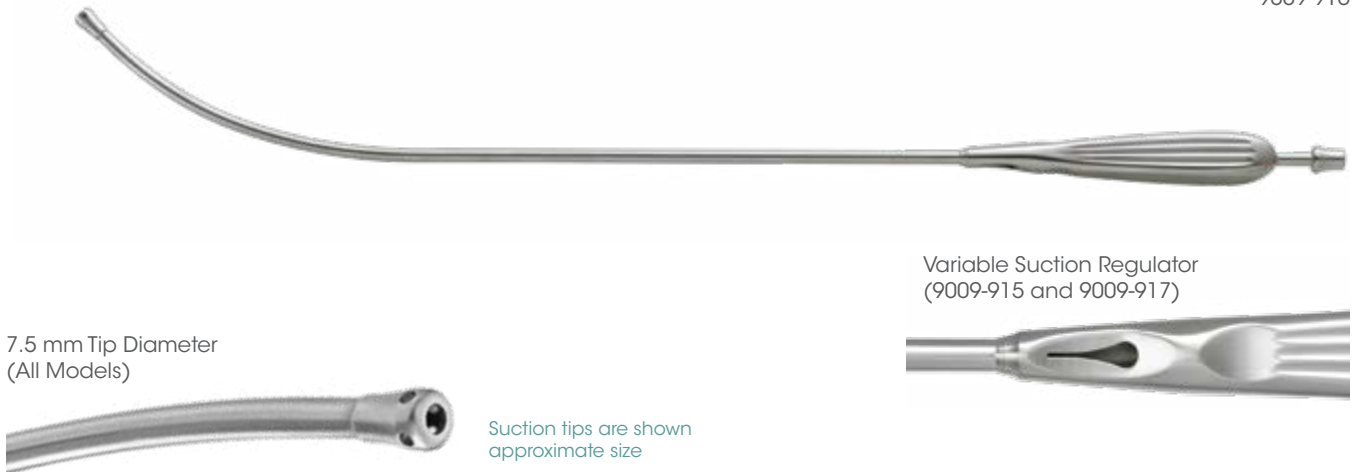

7.5 mm Tip Diameter
(All Models)

Variable Suction Regulator
(9009-915 and 9009-917)

Suction tips are shown
approximate size

VATS MIS SCANLAN®
Dennis Suction Instrument

Cat. No.	Description	Shaft	Working Length	Total Length
9009-914	Curved blunt tip 7.5 mm width tip	5 mm	8 3/4" (22 cm)	14 1/4" (36 cm)
9009-915	Variable suction Curved blunt tip 7.5 mm width tip			
9009-916	Curved blunt tip 7.5 mm width tip		12 1/2" (32 cm)	17 3/4" (45.5 cm)
9009-917	Variable suction Curved blunt tip 7.5 mm width tip			

Please check with your Scanlan Representative for Firm Sale status. Custom modifications available upon request.
For a complete listing of models visit... www.scanlaninternational.com





5 mm Tip Diameter
(9009-900 and 9009-901)

Variable Suction Regulator
(9009-901)

Suction tips are shown
approximate size



SCANLAN®

D'Amico Suction Instrument

Developed in cooperation with Thomas A. D'Amico, MD

Cat. No.	Description	Shaft	Working Length	Total Length
9009-900	Straight blunt tip 5 mm width tip	5 mm	12 1/2" (32 cm)	17 3/4" (45.5 cm)
9009-901	Variable suction Straight blunt tip 5 mm width tip			

Please Note...

Each Scanlan instrument is individually handcrafted to provide the surgeon with the highest quality, longest-lasting, precision instrument possible. Reflecting this unique process, all stated dimensions are approximate.

Please check with your Scanlan Representative for Firm Sale status. Custom modifications available upon request.

For a complete listing of models visit... www.scanlaninternational.com

Suction Instruments

9009-920

VATS / MIS



10 mm Tip Diameter
(9009-920 and 9009-921)



Suction tips are shown
approximate size

Variable Suction Regulator
(9009-921)



VATS **MIS** SCANLAN®
D'Amico Suction Instrument
Developed in cooperation with Thomas A. D'Amico, MD

Cat. No.	Description	Shaft	Working Length	Total Length
9009-920	Straight blunt tip 10 mm width tip	10 mm	12 1/2" (32 cm)	17 3/4" (45.5 cm)
9009-921	Variable suction Straight blunt tip 10 mm width tip			
9009-924	Curved blunt tip 10 mm width tip			
9009-925	Variable suction Curved blunt tip 10 mm width tip			

SCANLAN®

Suction Accessories

9009-905



VATS **MIS** SCANLAN®
Suction Accessories

Cat. No.	Description	Total Length
9009-905	Brush set, pack of 10, for 5 mm D'Amico and 3.2 mm Wolf and Dennis suction instruments	19" (48.3 cm)
9009-922	Brush set, pack of 10, for 10 mm D'Amico suction instruments	



Dennis Rib Cutter

VATS / MIS

9909-900



9909-900



9909-902



9909-904

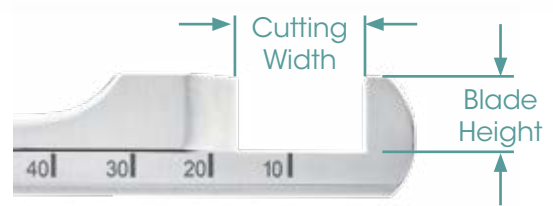

Cat. No.	Description	Cutting Width	Blade Height	Shaft	Working Length	Total Length
9909-900	Straight shaft	16 mm	10 mm	10 mm	11 1/2" (29 cm)	13 1/2" (34 cm)
9909-902	Straight shaft	25 mm	15 mm			
9909-904	Straight shaft	25 mm	20 mm			

Please Note...

Each Scanlan instrument is individually handcrafted to provide the surgeon with the highest quality, longest-lasting, precision instrument possible. Reflecting this unique process, all stated dimensions are approximate.



Periosteal Elevator

9009-823-14

VATS / MIS



VATS SCANLAN®
Periosteal Elevator

Cat. No.	Description	Working Length	Total Length
NEW 9009-823-14	Periosteal Elevator	10 3/4" (27.3 cm)	14 3/4" (37.5 cm)
NEW 9009-823-17		12 3/4" (32.5 cm)	16 3/4" (43.4 cm)

Please check with your Scanlan Representative for Firm Sale status. Custom modifications available upon request.
For a complete listing of models visit... www.scanlaninternational.com



VATS / MIS

4004-185



VATS **MIS** SCANLAN®
Stern™ Chest Tube Passer

Cat. No.	Description	Shaft	Working Length	Total Length
4004-185	Without ratchet	10 mm	6 7/8" (17.5 cm)	9 3/4" (24.8 cm)
4004-186	With ratchet			
4004-189	Without ratchet		11" (28 cm)	14" (35.6 cm)

Please Note...

Each Scanlan instrument is individually handcrafted to provide the surgeon with the highest quality, longest-lasting, precision instrument possible. Reflecting this unique process, all stated dimensions are approximate.

Suture Puller

9009-816

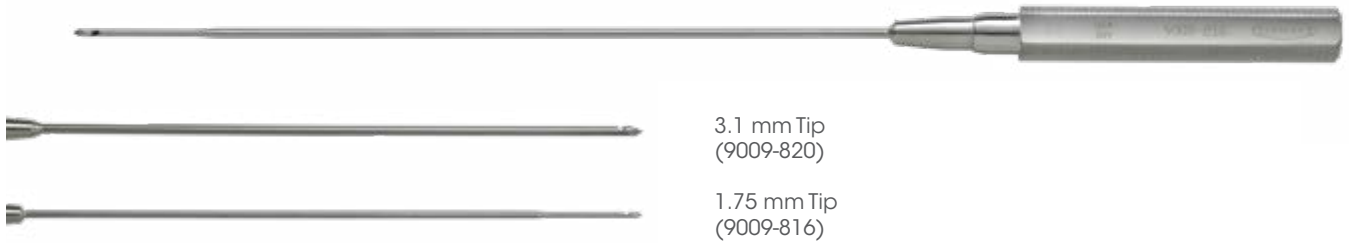

VATS / MIS

MIS SCANLAN®
Chitwood Suture Puller
 Developed in cooperation with W. Randolph Chitwood Jr., MD

Cat. No.	Description	Shaft	Working Length	Total Length
9009-816	Straight 1.75 mm Tip	3.1 mm	7 1/2" (19 cm)	11 1/2" (29 cm)
9009-820	Straight 3.1 mm Tip			

Please check with your Scanlan Representative for Firm Sale status. Custom modifications available upon request.
 For a complete listing of models visit... www.scanlaninternational.com



VATS / MIS

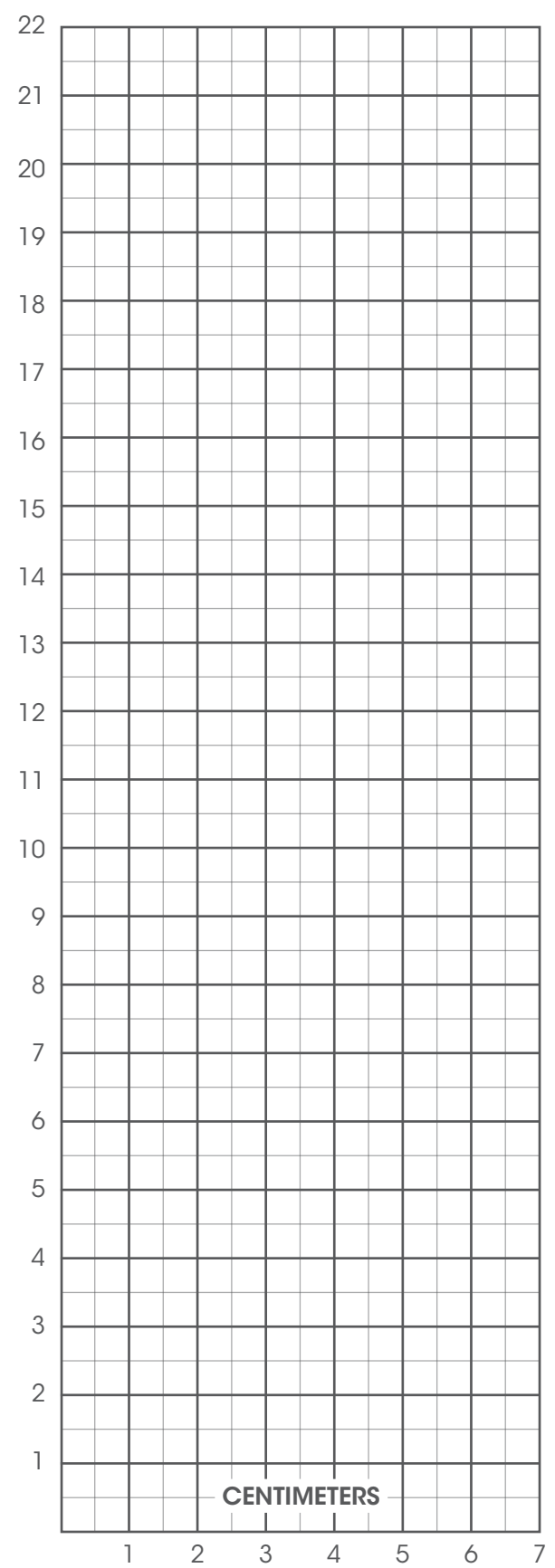
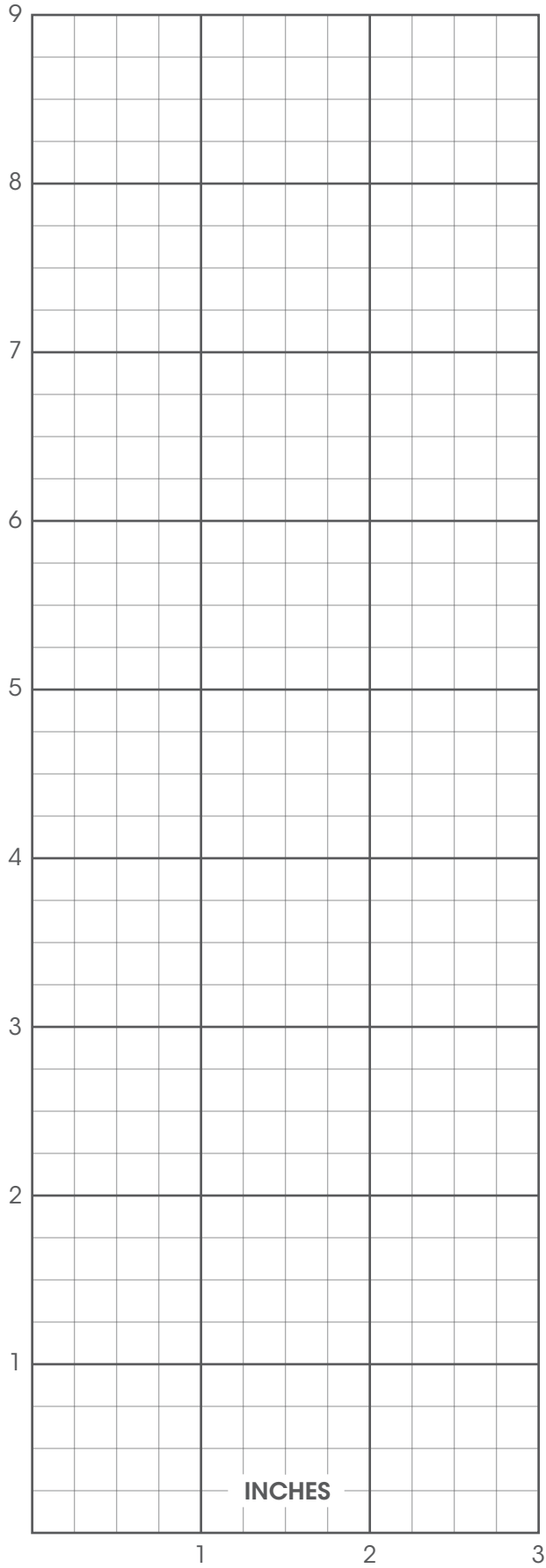



Scanturian® MIS Forceps 8.1

Scanturian® MIS Needle Holders..... 8.2

Scanturian® MIS Scissors 8.4

Scanturian® V.I.P.™ Sterilization Trays 8.6

V.I.P.™ Cleaning Tray 8.8



Scanturian® Minimally Invasive Surgical Instruments

MIS



ScanShield® Shaft Feature

The ScanShield® shaft feature surrounds the hinge mechanisms to avoid suture entrapment and intraoperative trauma to valve tissue and chordae tendineae (patent pending)



Tapered Shaft

The tapered shaft design allows for more robust moving mechanisms and efficient cleaning due to the increased shaft diameter at the distal tip



Scanturian® MIS Scissors with SUPER CUT™ Blades

A unique blade design - combining a razor edge with a scissors edge, these scissors produce a clean, forward cut, eliminating pinching or slipping of tissue

Instrument Identification

Color-coded and etching for easy intraoperative instrument identification

FORCEPS



NEEDLE HOLDERS



NEEDLE HOLDERS



SCISSORS



Titanium Handle

Well balanced, durable and handcrafted MIS Instrument design

Handle Knurling

Proven handle knurling design provides comfortable, secure grip and ergonomic handle design

Proximal End Cleaning Port

Luer lock flush port system allows for reliable automated and intraoperative instrument flushing

Please Note...

Each Scanlan instrument is individually handcrafted to provide the surgeon with the highest quality, longest-lasting, precision instrument possible. Reflecting this unique process, all stated dimensions are approximate.



Scanturian® MIS Forceps

MIS

9019-420-17



9019-420-25



MIS SCANLAN®
Scanturian® MIS Forceps

Cat. No.	Description	Distal Tip	Working Length	Total Length	Handle Color
9019-420-17	SCANLAN® Scanturian® MIS DeBakey Forceps 1.5 mm Straight Jaws Without Ratchets		6 3/4" (17 cm)	12 1/4" (31 cm)	
9019-420-25			9 7/8" (25 cm)	15 1/3" (39 cm)	
9019-430-17	SCANLAN® Scanturian® MIS DeBakey Forceps 2.5 mm Straight Jaws Without Ratchets		6 3/4" (17 cm)	12 1/4" (31 cm)	
9019-430-25			9 7/8" (25 cm)	15 1/3" (39 cm)	
9019-440-17	SCANLAN® Scanturian® MIS Resano Forceps 2.5 mm Straight Jaws Without Ratchets		6 3/4" (17 cm)	12- 1/4" (31 cm)	
9019-440-25			9 7/8" (25 cm)	15 1/3" (39 cm)	

Please Note...
Each Scanlan instrument is individually handcrafted to provide the surgeon with the highest quality, longest-lasting, precision instrument possible.
Reflecting this unique process, all stated dimensions are approximate.

Please check with your Scanlan Representative for Firm Sale status. Custom modifications available upon request.
For a complete listing of models visit... www.scanlaninternational.com



Scanturian® MIS Needle Holders

MIS

9019-610-17



9019-610-25



SCANLAN®
MIS Scanturian® MIS Needle Holders

Cat. No.	Description	Distal Tip	Suture Size	Working Length	Total Length	Handle Color
9019-610-17	SCANLAN® Scanturian® MIS Needle Holder Curved Carbon-Inlay Jaws with Ratchet		2-0 and Smaller	6 3/4" (17 cm)	12 1/4" (31 cm)	
9019-610-25				9 7/8" (25 cm)	15 1/3" (39 cm)	
9019-614-17	SCANLAN® Scanturian® MIS Needle Holder Straight Carbon-Inlay Jaws with Ratchet			6 3/4" (17 cm)	12 1/4" (31 cm)	
9019-614-25				9 7/8" (25 cm)	15 1/3" (39 cm)	
9019-630-17	SCANLAN® Scanturian® MIS Needle Holder Straight Carbon-Inlay Jaws with Ratchet		4-0 and Smaller	6 3/4" (17 cm)	12 1/4" (31 cm)	
9019-630-25				9 7/8" (25 cm)	15 1/3" (39 cm)	

Please Note...

Each Scanlan instrument is individually handcrafted to provide the surgeon with the highest quality, longest-lasting, precision instrument possible. Reflecting this unique process, all stated dimensions are approximate.



Scanturian® MIS Needle Holders

9019-640-17



9019-640-25



MIS

MIS SCANLAN®
Scanturian® MIS Needle Holders

Cat. No.	Description	Distal Tip	Suture Size	Working Length	Total Length	Handle Color
9019-640-17	SCANLAN® Scanturian® MIS Needle Holder Straight DIAMOND DUST™ Jaws with Ratchet		5-0 and Smaller	6 3/4" (17 cm)	12 1/4" (31 cm)	
9019-640-25				9 7/8" (25 cm)	15 1/3" (39 cm)	

Please check with your Scanlan Representative for Firm Sale status. Custom modifications available upon request.
For a complete listing of models visit... www.scanlaninternational.com



Scanturian® MIS Scissors

MIS

9019-722-17SC



9019-722-25SC



MIS SCANLAN®
Scanturian® MIS Scissors

Cat. No.	Description	Distal Tip	Working Length	Total Length	Handle Color
9019-710-17SC	SCANLAN® Scanturian® MIS Super Cut™ Scissors Straight Fine Blades, 1 cm, Blunt Tips		6 3/4" (17 cm)	12 1/4" (31 cm)	
9019-710-25SC			9 7/8" (25 cm)	15 1/3" (39 cm)	
9019-715-17SC	SCANLAN® Scanturian® MIS Super Cut™ Scissors Curved Fine Blades, 1 cm, Blunt Tips		6 3/4" (17 cm)	12 1/4" (31 cm)	
9019-715-25SC			9 7/8" (25 cm)	15 1/3" (39 cm)	
9019-720-17SC	SCANLAN® Scanturian® MIS Super Cut™ Scissors 15° Curved Blades		6 3/4" (17 cm)	12 1/4" (31 cm)	
9019-720-25SC			9 7/8" (25 cm)	15 1/3" (39 cm)	
9019-722-17SC	SCANLAN® Scanturian® MIS Super Cut™ Scissors 30° Curved Blades		6 3/4" (17 cm)	12 1/4" (31 cm)	
9019-722-25SC			9 7/8" (25 cm)	15 1/3" (39 cm)	
9019-724-17SC	SCANLAN® Scanturian® MIS Super Cut™ Scissors 70° Curved Blades		6 3/4" (17 cm)	12 1/4" (31 cm)	
9019-724-25SC			9 7/8" (25 cm)	15 1/3" (39 cm)	

Please Note...

Each Scanlan instrument is individually handcrafted to provide the surgeon with the highest quality, longest-lasting, precision instrument possible. Reflecting this unique process, all stated dimensions are approximate.

Scanturian® MIS Scissors

MIS

9019-740-17SC



9019-740-25SC



MIS SCANLAN®
Scanturian® MIS Scissors

Cat. No.	Description	Distal Tip	Working Length	Total Length	Handle Color
9019-740-17SC	SCANLAN® Scanturian® MIS Super Cut™ Potts Scissors 45° Angled Fine Blades		6 3/4" (17 cm)	12 1/4" (31 cm)	
9019-740-25SC			9 7/8" (25 cm)	15 1/3" (39 cm)	
9019-748-17SC	SCANLAN® Scanturian® MIS Super Cut™ Potts Scissors 90° Angled Fine Blades		6 3/4" (17 cm)	12 1/4" (31 cm)	
9019-748-25SC			9 7/8" (25 cm)	15 1/3" (39 cm)	
9019-750-17SC	SCANLAN® Scanturian® MIS Super Cut™ Potts Scissors 125° Angled Fine Blades		6 3/4" (17 cm)	12 1/4" (31 cm)	
9019-750-25SC			9 7/8" (25 cm)	15 1/3" (39 cm)	

Please check with your Scanlan Representative for Firm Sale status. Custom modifications available upon request.
For a complete listing of models visit... www.scanlaninternational.com





SCANLAN®

V.I.P.™ Sterilization Trays

Metal Sterilization Trays, Aluminum, Scan-Guard™ Silicone Inserts, Detachable Lids

Cat. No.	Description	Dimensions	Capacity
2160-03	SCANLAN® Scanturian® Valued Instrument Protection (V.I.P.™) Sterilization Tray	21 3/4" x 10 1/4" x 2 1/2" (55.2cm x 26cm x 6.4cm)	Up to 10 MIS Instruments

All trays are steam, Immediate Use Steam Sterilization (IUSS) and ETO sterilization compatible
 Firm Sale - May be available for evaluation

Please Note...

Each Scanlan instrument is individually handcrafted to provide the surgeon with the highest quality, longest-lasting, precision instrument possible. Reflecting this unique process, all stated dimensions are approximate.

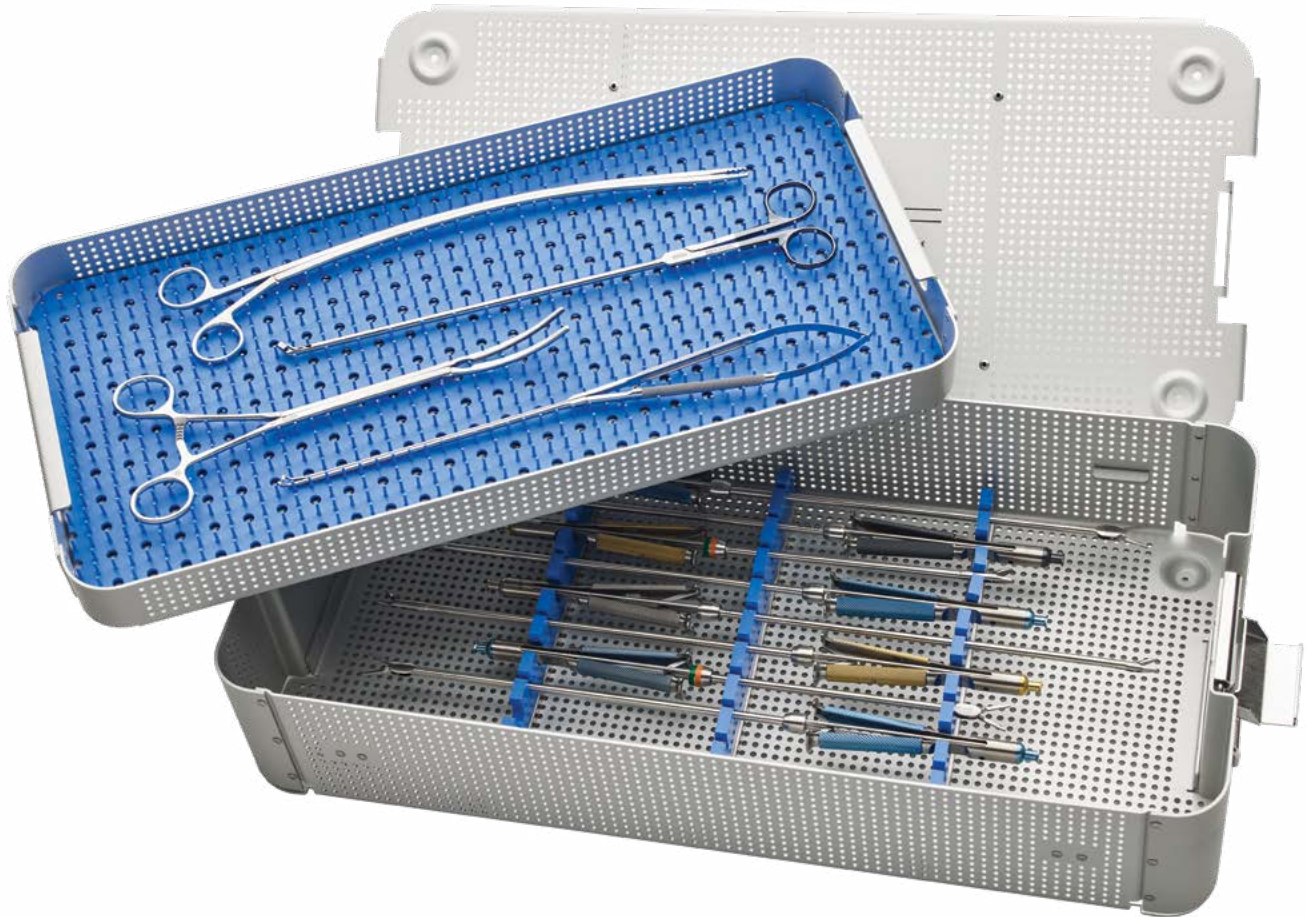

SCANLAN®

V.I.P.™ Sterilization Trays

Metal Sterilization Trays, Aluminum, Scan-Guard™ Silicone Inserts, Detachable Lids

Cat. No.	Description	Dimensions	Capacity
2161-03	SCANLAN® Scanturian® Valued Instrument Protection (V.I.P.™) Sterilization Tray with additional tray insert	21 3/4" x 10 1/4" x 4" (55.2 cm x 26 cm x 10 cm)	Up to 18 MIS Instruments

All trays are steam, Immediate Use Steam Sterilization (IUSS) and ETO sterilization compatible
 Firm Sale - May be available for evaluation

Please check with your Scanlan Representative for Firm Sale status. Custom modifications available upon request.
 For a complete listing of models visit... www.scanlaninternational.com





SCANLAN®
V.I.P.™ Cleaning Tray
 Metal Cleaning Tray, Aluminum, Scan-Guard™ Silicone Inserts

Cat. No.	Description	Dimensions	Capacity
2162-03	SCANLAN® Valued Instrument Protection (V.I.P.™) Cleaning Tray	18 7/8" x 9 7/8" x 2 1/4" (48cm x 25cm x 5.8cm)	Up to 10 instruments

Firm Sale - May be available for evaluation

Please Note...

Each Scanlan instrument is individually handcrafted to provide the surgeon with the highest quality, longest-lasting, precision instrument possible. Reflecting this unique process, all stated dimensions are approximate.

Please check with your Scanlan Representative for Firm Sale status. Custom modifications available upon request.

For a complete listing of models visit... www.scanlaninternational.com

COLOR CODING

SURG-I-BAND® Color Coding System

Color Coding 9.1
 Carousel 9.1
 Dispenser 9.1
 Remover 9.1
 Designs 9.2
 Labels 9.3
 Data Matrix 9.4

EASY-TAG™ Tracking System

EASY-TAG™ 9.5
 EASY-TAG™ Small 9.5
 EASY-TAG™ Mini 9.5
 EASY-TAG™ Custom Printing 9.6
 EASY-TAG™ Pre-Printed 9.7
 EASY-TAG™ Plus 9.8

TRAVELER™ Autoclavable Pouch 9.9
 TIP GUARD™ Instrument Protectors 9.10
 V.I.P.™ Sterilization Trays
 Metal 9.12
 Plastic 9.14



INSTRUMENT CARE

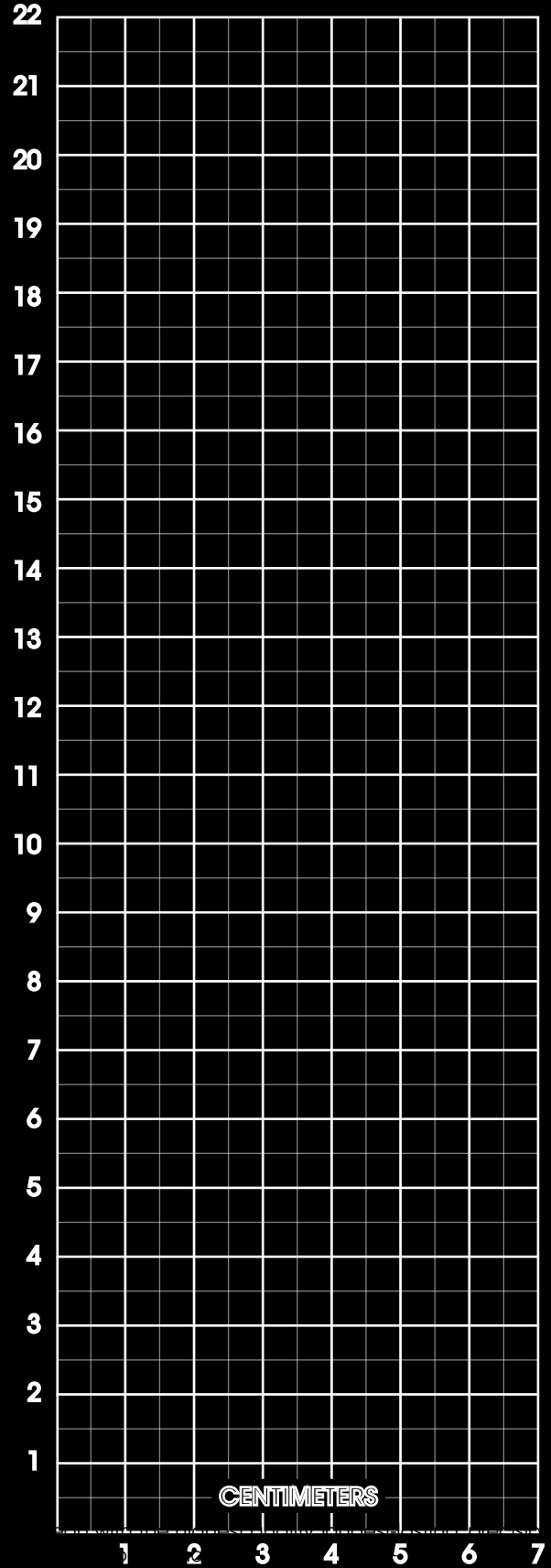
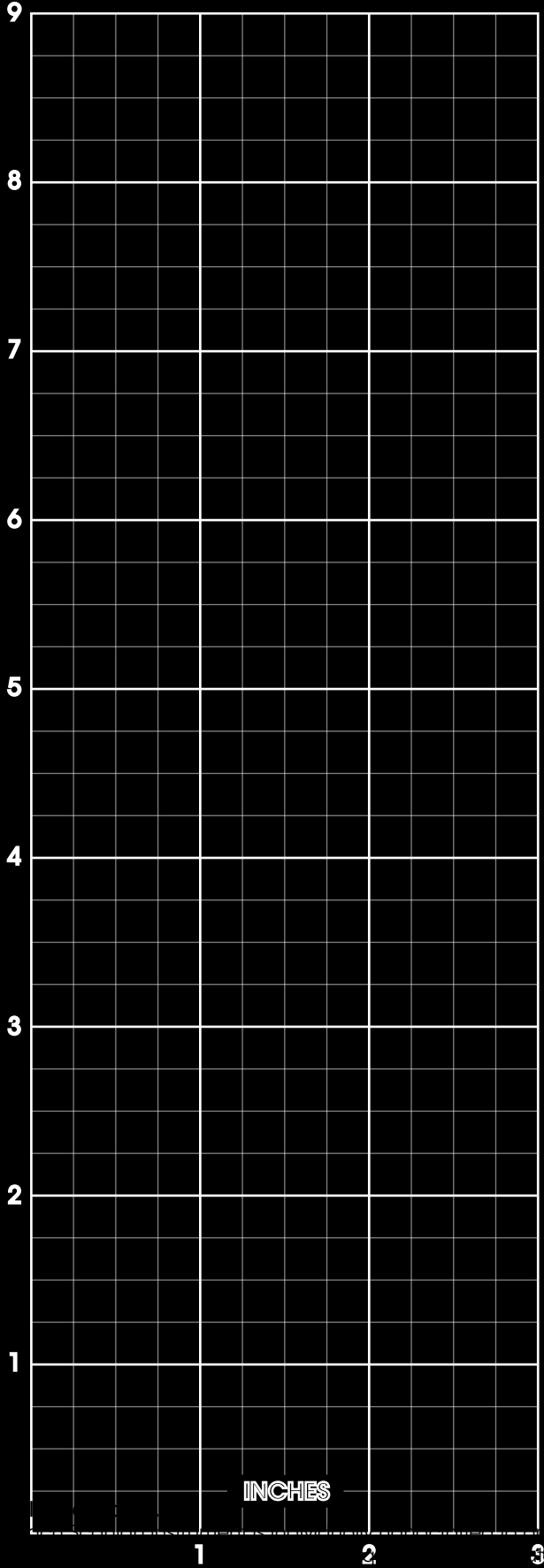

SCANLAN®

SURG-I-BAND® Color Coding

Original Surg-I-Band® (1/4") and narrow Surg-I-Band® (1/8") color coding, available in 14 bright colors, offers a multitude of color coding combinations to identify instruments by surgeon, set, specialty and suite. In addition, Surg-I-Band® color coding is long lasting – providing greater value by saving time and labor. Not made with natural rubber latex. Tested for steam, ETO and Immediate Use Steam Sterilization (IUSS).

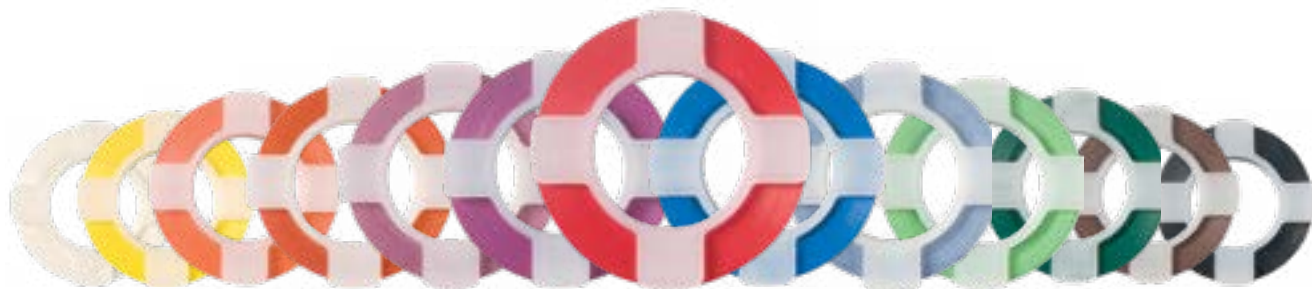

1/8" Narrow Cat. No.	1/4" Original Cat. No.	Description	1/8" Narrow Cat. No.	1/4" Original Cat. No.	Description
1001-630	1001-64	Red	1001-637	1001-71	Black
1001-631	1001-65	Yellow	1001-638	1001-94	Glo-Orange
1001-632	1001-66	Orange	1001-639	1001-95	Purple
1001-633	1001-67	Blue	1001-640	1001-96	Lime Green
1001-634	1001-68	Green	1001-641	1001-97	Grey
1001-635	1001-69	Brown	1001-642	1001-98	Pink
1001-636	1001-70	White	1001-643	1001-99	Light Blue



SCANLAN®

SURG-I-BAND® Dispenser



- **Easy to use** – Surg-I-Band® color coding spools snap on securely and can be removed quickly
- **Precise cut** – Dispenser eliminates the need for awkward scissors or blades when using Surg-I-Band® color coding
- **Protective cover** - guards against damage to blade and color coding
- **Compact** – provides a small, lightweight design
- **Reusable** – ensuring greater economy

Cat. No.	Description
1001-60	Surg-I-Band® Dispenser (Does not include Surg-I-Band® spools)

SCANLAN®

SURG-I-BAND® Remover



- **Saves time** – allows quick removal of Surg-I-Band® color coding
- **Safe** – eliminates use of razors or other sharp instruments that may damage the surface of instruments or cause injury to personnel
- **Reusable** – removes hundreds of bands

Cat. No.	Description
1001-49	Surg-I-Band® Remover

SCANLAN®

SURG-I-BAND® Carousel

- **Efficient** – provides fast, easy application of Surg-I-Band® color coding
- **Excellent organization** – holds 12 Surg-I-Band® dispensers
- **Rotating top** – provides easy access to each color
- **Storage** – conveniently holds Scanlan® Tip Guard™ instrument protectors
- **Easy to use** – Surg-I-Band® spools snap on securely and can be removed quickly

Cat. No.	Description
1001-59	Carousel Only
1001-61	Carousel with 12 Dispensers (Does not include Surg-I-Band® spools or Tip-Guard™)



Color Coding System

SCANLAN®

SURG-I-BAND® Designs On Spools

- **40 designs** – numbers, symbols and abbreviations
- **Multiple colors**
- **Durable** – resistant to flaking, chipping, peeling and cracking through multiple sterilization cycles
- Tested for steam, ETO and Immediate Use Steam Sterilization (IUSS)
- 1/4" Width
- Not made with natural rubber latex



Red Designs

Cat. No.	Description	Design
1001-1000	Zero	000000000
1001-1001	One	11111111111
1001-1002	Two	222222222
1001-1003	Three	333333333
1001-1004	Four	444444444
1001-1005	Five	555555555
1001-1006	Six	666666666
1001-1007	Seven	777777777
1001-1008	Eight	888888888
1001-1009	Nine	999999999
1001-1010	Hearts	♥♥♥♥♥♥♥♥
1001-1011	Bones	☠☠☠☠☠☠☠☠
1001-1012	Crosses	✚✚✚✚✚✚✚✚
1001-1013	Eyes	👁👁👁👁👁👁👁👁

Black Designs

Cat. No.	Description	Design
1001-1014	Zero	000000000
1001-1015	One	11111111111
1001-1016	Two	222222222
1001-1017	Three	333333333
1001-1018	Four	444444444
1001-1019	Five	555555555
1001-1020	Six	666666666
1001-1021	Seven	777777777
1001-1022	Eight	888888888
1001-1023	Nine	999999999
1001-1024	Hearts	♥♥♥♥♥♥♥♥
1001-1025	Bones	☠☠☠☠☠☠☠☠
1001-1026	Crosses	✚✚✚✚✚✚✚✚
1001-1027	Eyes	👁👁👁👁👁👁👁👁

Blue Designs

Cat. No.	Description	Design
1001-1028	OB	OB OB OB OB OB OB OB OB
1001-1029	EYE	EYE EYE EYE EYE EYE EYE EYE EYE
1001-1030	GEN	GEN GEN GEN GEN GEN GEN GEN GEN
1001-1031	GYN	GYN GYN GYN GYN GYN GYN GYN GYN
1001-1032	BAR	BAR BAR BAR BAR BAR BAR BAR BAR
1001-1033	URO	URO URO URO URO URO URO URO URO
1001-1034	NEU	NEU NEU NEU NEU NEU NEU NEU NEU
1001-1035	L&D	L&D L&D L&D L&D L&D L&D L&D L&D
1001-1036	Feet	👣👣👣👣👣👣👣👣
1001-1037	Baby Bottle	🍼🍼🍼🍼🍼🍼🍼🍼
1001-1038	Bones	☠☠☠☠☠☠☠☠
1001-1039	Smiley Faces	😊😊😊😊😊😊😊😊
1001-1040	Hearts	♥♥♥♥♥♥♥♥
1001-1041	Hands	👐👐👐👐👐👐👐👐

Pink Designs

Cat. No.	Description	Design
1001-1042	OB	OB OB OB OB OB OB OB OB
1001-1043	EYE	EYE EYE EYE EYE EYE EYE EYE EYE
1001-1044	GEN	GEN GEN GEN GEN GEN GEN GEN GEN
1001-1045	GYN	GYN GYN GYN GYN GYN GYN GYN GYN
1001-1046	BAR	BAR BAR BAR BAR BAR BAR BAR BAR
1001-1047	URO	URO URO URO URO URO URO URO URO
1001-1048	NEU	NEU NEU NEU NEU NEU NEU NEU NEU
1001-1049	L&D	L&D L&D L&D L&D L&D L&D L&D L&D
1001-1050	Feet	👣👣👣👣👣👣👣👣
1001-1051	Baby Bottle	🍼🍼🍼🍼🍼🍼🍼🍼
1001-1052	Bones	☠☠☠☠☠☠☠☠
1001-1053	Smiley Faces	😊😊😊😊😊😊😊😊
1001-1054	Hearts	♥♥♥♥♥♥♥♥
1001-1055	Hands	👐👐👐👐👐👐👐👐

Green Designs

Cat. No.	Description	Design
1001-1056	ETO	ETO ETO ETO ETO ETO ETO ETO ETO
1001-1057	ENDO	ENDO ENDO ENDO ENDO ENDO ENDO ENDO ENDO
1001-1058	GI	GI GI GI GI GI GI GI GI
1001-1059	CV	CV CV CV CV CV CV CV CV
1001-1060	ER	ER ER ER ER ER ER ER ER
1001-1061	ASC	ASC ASC ASC ASC ASC ASC ASC ASC
1001-1062	CCU	CCU CCU CCU CCU CCU CCU CCU CCU
1001-1063	DEN	DEN DEN DEN DEN DEN DEN DEN DEN
1001-1064	ENT	ENT ENT ENT ENT ENT ENT ENT ENT
1001-1065	ICU	ICU ICU ICU ICU ICU ICU ICU ICU
1001-1066	SPD	SPD SPD SPD SPD SPD SPD SPD SPD
1001-1067	Smiley Faces	😊😊😊😊😊😊😊😊
1001-1068	Circles	●●●●●●●●
1001-1069	Stars	★ ★ ★ ★ ★ ★ ★ ★

Purple Designs















Cat. No.	Description	Design
1001-1070	ETO	ETO ETO ETO ETO ETO ETO ETO ETO
1001-1071	ENDO	ENDO ENDO ENDO ENDO ENDO ENDO ENDO ENDO
1001-1072	GI	GI GI GI GI GI GI GI GI
1001-1073	CV	CV CV CV CV CV CV CV CV
1001-1074	ER	ER ER ER ER ER ER ER ER
1001-1075	ASC	ASC ASC ASC ASC ASC ASC ASC ASC
1001-1076	CCU	CCU CCU CCU CCU CCU CCU CCU CCU
1001-1077	DEN	DEN DEN DEN DEN DEN DEN DEN DEN
1001-1078	ENT	ENT ENT ENT ENT ENT ENT ENT ENT
1001-1079	ICU	ICU ICU ICU ICU ICU ICU ICU ICU
1001-1080	SPD	SPD SPD SPD SPD SPD SPD SPD SPD
1001-1081	Triangles	▲▲▲▲▲▲▲▲
1001-1082	Circles	●●●●●●●●
1001-1083	Stars	★ ★ ★ ★ ★ ★ ★ ★

SCANLAN®

SURG-I-BAND® Color Coding Sheets

- **Three patterns** – polka-dots, checkered and Jammie-Stripes™
- **14 solid colors**
- **Durable** – resistant to flaking, chipping, peeling and cracking through multiple sterilization cycles
- **Sterilizable** – Tested for steam, ETO and Immediate Use Steam Sterilization (IUSS)
- **Pre-cut label sheet** (8 1/2" x 11") – 1/4" width, 374" per sheet
 - 230 ea. of 1.0"
 - 40 ea. of 1.5"
 - 12 ea. of 2.0"
 - 12 ea. of 5.0"
- Not made with natural rubber latex

Solid Labels

Cat. No.	Description	
1001-800	Red	
1001-801	Yellow	
1001-802	Orange	
1001-803	Blue	
1001-804	Green	
1001-805	Brown	
1001-806	White	
1001-807	Black	
1001-808	Glo-Orange	
1001-809	Purple	
1001-810	Lime Green	
1001-811	Grey	
1001-812	Pink	
1001-813	Light Blue	

Polka-Dot Labels

Cat. No.	Description	
1001-814	Red/White	
1001-815	Yellow/White	
1001-816	Green/White	
1001-817	Black/White	

Jammie-Stripes Labels

Cat. No.	Description	
1001-822	Red/White	
1001-823	Yellow/White	
1001-824	Green/White	
1001-825	Black/White	

Checkered Labels

Cat. No.	Description	
1001-818	Red/White	
1001-819	Yellow/White	
1001-820	Green/White	
1001-821	Black/White	



Color Coding System

SCANLAN®

SURG-I-BAND® Color Coding Data Matrix

Offering Precise Instrument / Device Tracking

Surg-I-Band® Data Matrix Color Coding Barcode offers hospitals an excellent system to organize and track surgical instrumentation and devices. Combining the benefits of Surg-I-Band® color coding with the technology of bar coding, Surg-I-Band® Data Matrix provides a fast, easy and precise organizational system.

- **Economy** – Each spool contains 200 unique data matrix barcodes
- **14 colors** – For fast and easy identification
- **Safety** – Clinically tested for steam, ETO and Immediate Use Steam Sterilization (IUSS)
- **Trouble Free** – Easy application and removal without damaging instrument
- **Versatility** – Can be used on most sizes and designs of instruments
- Compatible with instrument tracking software and high-density data matrix ECC 200 scanners
- May be used in combination with Surg-I-Band® Dispenser, Remover and Carousel
- 1/4" Width
- Not made with natural rubber latex



SCANLAN®

SURG-I-BAND® Color Coding Data Matrix

Pre-Cut Assorted Sizes

Designed for tracking and barcoding larger diameter instruments.

Pre-cut label sheet (8 1/2" x 11") - 1/4" width, 132 barcodes per sheet

- 72 each of 1.75"
- 27 each of 3"
- 26 each of 4"
- 7 each of 5"

Description	Censitrac™ Compatible	Assorted Sizes Sheets
Red	1001-1098	1001-1112
Yellow	1001-1099	1001-1113
Orange	1001-1100	1001-1114
Blue	1001-1101	1001-1115
Green	1001-1102	1001-1116
Brown	1001-1103	1001-1117
White	1001-1104	1001-1118
Black	1001-1105	1001-1119
Glo-Orange	1001-1106	1001-1120
Purple	1001-1107	1001-1121
Lime Green	1001-1108	1001-1122
Grey	1001-1109	1001-1123
Pink	1001-1110	1001-1124
Light Blue	1001-1111	1001-1125

SCANLAN®

EASY-TAG™ Tracking System

A cost-effective, easy, secure method of tracking instruments, trays, equipment & repairs through cleaning, decontamination and sterilization processes.

- **Compatible** - ETO, Steam and Plasma
- **Versatile Surface** - allows placement of pre-printed labels or can be written on both sides of tag
- **No Adhesives** - quick, easy and secure
- **Easy to Apply** - the flexible handle loops around instruments and tray handles
- **Easy to Remove** - Tear-Away™ handle provides easy separation after use
- **Color Coded** - for fast and easy identification
- Not made with natural rubber latex
- Approximately 250 Tags per spool



2.5" x 4.75"
(63.5 mm x 120.65 mm)

SCANLAN®

EASY-TAG™

Cat. No.	Description
1001-904	EASY-TAG™, Black
1001-905	EASY-TAG™, Red
1001-906	EASY-TAG™, Yellow
1001-907	EASY-TAG™, Blue
1001-908	EASY-TAG™, Green
1001-909	EASY-TAG™, Pink
1001-910	EASY-TAG™, Orange

SCANLAN®

EASY-TAG™ Small

Cat. No.	Description
1001-914	EASY-TAG™, White
1001-915	EASY-TAG™, Red
1001-916	EASY-TAG™, Purple
1001-917	EASY-TAG™, Light Blue
1001-918	EASY-TAG™, Lime Green
1001-919	EASY-TAG™, Hot Pink
1001-920	EASY-TAG™, Orange



2.5" x 2.875"
(63.5 mm x 73.03 mm)

SCANLAN®

EASY-TAG™ Mini

Cat. No.	Description
1001-964	EASY-TAG™, Black
1001-965	EASY-TAG™, Red
1001-966	EASY-TAG™, Yellow
1001-967	EASY-TAG™, Blue
1001-968	EASY-TAG™, Green
1001-969	EASY-TAG™, Pink
1001-970	EASY-TAG™, Orange



0.5" x 2.25"
(12.7 mm x 57.15 mm)

Approximately 250 Tags per box



Tracking and Tagging System

SCANLAN®

EASY-TAG™ Pre-printed

For even more customer convenience, Scanlan offers pre-printed EASY-TAGS™!

Cat. #	Description	Cat. #	Description
1001-921	Blue, ENDOSCOPE CLEANED	1001-927	Red, BIOHAZARD
1001-922	Green, ENDOSCOPE CLEANED Month / Date	1001-928	Red, BROKEN DO NOT USE
1001-923	Red, RAPID TURNOVER	1001-929	Orange, TRAY IS INCOMPLETE
1001-924	Red, REPAIR	1001-930	Red, ENDOSCOPE REPAIR
1001-925	Green, CLEAN READY TO USE	1001-931	Green, HLD PROCESS COMPLETED
1001-926	Black, LOANER	1001-936	EASY-TAG™ Small, Red, REPAIR 2.5" x 2.875" (63.5mm x 73.03mm)

1001-921



1001-927



SCANLAN®
EASY-TAG™ Pre-printed Mini
2.25" x .5" (57.15 mm x 12.7 mm)

Cat. # Description

- 1001-971 Green, CLEAN
- 1001-972 Green, LOANER
- 1001-973 Red, REPAIR
- 1001-974 Yellow, SHARPEN
- 1001-975 Orange, BROKEN
- 1001-976 Blue, RAPID TURNOVER
- 1001-977 Black, DIRTY

1001-922



1001-928



1001-923

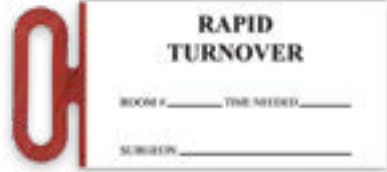

1001-929



1001-971



1001-924



1001-930



1001-972



1001-973



1001-925



1001-931



1001-974



1001-975



1001-926



1001-936



1001-976



1001-977



Tracking and Tagging System

SCANLAN®

EASY-TAG™ Custom Printing

Customize your EASY-TAG™ Tracking System to meet the unique needs within your hospital. Simply define your message, and we do the rest! Your custom print EASY-TAG™ will be developed and printed to your specific needs.

Your custom message, combined with the unique advantages of the EASY-TAG™ Tracking System, offers a powerful combination – providing a cost-effective, secure method of tracking instruments, trays, equipment & repairs through cleaning, decontamination and sterilization processes.



SCANLAN®

EASY-TAG™ Custom

2.5" x 4.75" (63.5 mm x 120.65 mm)

Cat. #	Description
--------	-------------

- | | |
|-----------|--------|
| 1001-904C | Black |
| 1001-905C | Red |
| 1001-906C | Yellow |
| 1001-907C | Blue |
| 1001-908C | Green |
| 1001-909C | Pink |
| 1001-910C | Orange |

Not made with natural rubber latex
Custom made at time of order. Firm sale.



SCANLAN®

EASY-TAG™ Small Custom

2.5" x 2.875" (63.5 mm x 73.03 mm)

Cat. #	Description
--------	-------------

- | | |
|-----------|------------|
| 1001-914C | White |
| 1001-915C | Red |
| 1001-916C | Purple |
| 1001-917C | Light Blue |
| 1001-918C | Lime Green |
| 1001-919C | Hot Pink |
| 1001-920C | Orange |

Tracking and Tagging System

SCANLAN® EASY-TAG™ Plus

Patented flexible/elastic handle technology of the Easy-Tag Tracking System, PLUS an adhesive back allowing the user to attach a machine printout, note, or message.

- **Easy to Apply** - the flexible handle loops over endoscope knobs, around instruments, tray handles and carts.
- **Adhesive Back** - allows placement of a machine print out, note or message to the elastic handle.
- Not made with natural rubber latex
- Approximately 500 tags per spool



Cat. No.	Description
1001-940	Easy-Tag™ Plus, Silver*

* Not intended for sterilization

SCANLAN®

TRAVELER™ Autoclavable Pouch

The Scanlan® Traveler™ Autoclavable Pouch is a fast and reliable method of securing important documents to the outside of containers. Made of durable material, it is semi-transparent and features a spacious pouch to easily contain large documents. Custom labels may also be applied to the exterior of the pouch to support the identification and tracking of the contents.

- Not adversely affected by autoclave
- **Sized to Fit** – Holds instrument count sheet with only minimal folding
- **Contents Secure** – Fastener and dual hanging hole ensure contents of pouch do not fall out
- **Easy On** – Adjustable fastener makes it easy to put on and take off, no scissors and no adhesives to leave residue behind
- **Durable** – Strong 3 mil material
- **Large Surface Area** – Perfect for placing a bar code label or to write on
- **Versatile** – Autoclavable pouch is great for housing various documents required to go through the sterilization process with the container
- Not made with natural rubber latex

Cat. No.	Description
1001-950	Traveler™ Autoclavable Pouch 100 pouches (6.5" x 6.5") and 100 fasteners/box
1001-951	Traveler™ Autoclavable Pouch 100 pouches (6.5" x 6.5") (Fasteners not included)



PATENT #8,955,208



Instrument Protectors

SCANLAN®

TIP-GUARD™ Instrument Protectors

Ensuring safe, cost-effective protection of blade tips and edges for all surgical instrumentation.

- **Superior protection** – safeguards delicate tips and edges of surgical instrumentation
- Clinically tested for steam, Immediate Use Steam Sterilization (IUSS) and ETO sterilization (sterility report available upon request)
- **Versatile** – conforms to various shapes and angles
- **Design variety** – available in colored, tinted, clear and vented
- **Economical** – provides cost-effective protection
- Radiopaque
- Not made with natural rubber latex



Instrument Protectors

Colored

1001-89	1001-88	1001-87	1001-91	1001-90	1001-85	1001-86	1001-93	1001-92
Black	Brown	Orange	Maroon	Yellow	Red	Green	Blue	White

1001-84 Variety Pack - 9 assorted color-coded sizes, 100 pieces per package

Tinted

1001-305	1001-304	1001-303	1001-307	1001-306	1001-301	1001-302	1001-309	1001-308
Black	Brown	Orange	Maroon	Yellow	Red	Green	Blue	White

1001-300 Variety Pack - 9 assorted color-coded sizes, 100 pieces per package

Clear

1001-205	1001-204	1001-203	1001-207	1001-206	1001-201	1001-202	1001-209	1001-208
----------	----------	----------	----------	----------	----------	----------	----------	----------

1001-200 Variety Pack - 9 assorted color-coded sizes, 100 pieces per package

Tinted

1001-405	1001-404	1001-403	1001-407	1001-406	1001-401	1001-402	1001-409	1001-408
Black	Brown	Orange	Maroon	Yellow	Red	Green	Blue	White

1001-400 Variety Pack - 9 assorted color-coded sizes, 100 pieces per package

Width:	1/8" (3.2 mm)	1/16" (1.6 mm)	1/16" (1.6 mm)	13/32" (10.3 mm)	3/16" (4.8 mm)	1/8" (3.2 mm)	7/64" (2.8 mm)	5/64" (2 mm)	1/16" (1.6 mm)
Length:	1" (25.4 mm)	1" (25.4 mm)	1" (25.4 mm)	3/4" (19 mm)	1" (25.4 mm)	1" (25.4 mm)	3/4" (19 mm)	3/4" (19 mm)	3/4" (19 mm)
Height:	1" (25.4 mm)	5/8" (15.9 mm)	3/8" (9.5 mm)						



SCANLAN®
V.I.P.™ Sterilization Trays

SCANLAN® instrument sterilization trays assist in the sterilization, storage, and transport of surgical instruments. All trays will withstand repeated ETO, Immediate Use Steam Sterilization (IUSS), steam or wrapped sterilization and include silicone mats to securely hold instruments and assure safety.



2133-03

SCANLAN®
V.I.P.™ Sterilization Trays

Cat. No.	Description	Dimensions	Capacity
2133-03	Micro sterilization tray with Scan-Guard™ silicone mat and hardware	1.5" x 3.5" x 1" (3.81 cm x 8.89 cm x 2.54 cm)	3-4
2135-03	SCANLAN® V.I.P.™ Sterilization Tray With Scan-Guard™ Silicone Mat (Holds 8-10 Bulldogs)	8 1/4" x 3 1/4" x 1 1/2" (21 cm x 8.3 cm x 3.8 cm)	8-10



2135-03

(Surgical parts not included)
Firm Sale – May be available for evaluation

2145-03



2146-03



2150-03



SCANLAN®
V.I.P.™ Sterilization Trays

Metal Sterilization Trays, Aluminum, Scan-Guard™ Silicone Inserts, Detachable Lids

Cat. No.	Description	Dimensions	Capacity
2145-03	Silver-gray color with Scan-Guard™ brackets Firm Sale – May be available for evaluation	10.5" x 21" x 2.5" (26 cm x 53 cm x 6.4 cm)	Up to 12 VATS / MIS Instruments
2146-03	Silver-gray color, additional tray insert with full Scan-Guard™ silicone brackets mat Firm Sale – May be available for evaluation	10.25" x 21.75" x 4" (26 cm x 55.2 cm x 10 cm)	20+ VATS / MIS Instruments
2150-03	Large capacity tray; Scan-Guard™ silicone brackets & mat Firm Sale – May be available for evaluation	29" x 8.37" x 1.5" (73.7 cm x 21.3 cm x 3.8 cm)	<ul style="list-style-type: none"> • Holds the entire SCANLAN® Tunneling System • 8 VATS / MIS Instruments • 20 Instruments

All trays are steam, Immediate Use Steam Sterilization (IUSS) and ETO sterilization compatible
Firm Sale – May be available for evaluation

V.I.P.™ Sterilization Trays (Valued Instrument Protection) | Metal

INSTRUMENT CARE

2138-03



2139-03



2140-03



2141-03



2142-03



SCANLAN®

V.I.P.™ Sterilization Trays

Metal Sterilization Trays, Aluminum, Scan-Guard™ Silicone Inserts, Detachable Lids

Cat. No.	Description	Dimensions	Capacity
2138-03	Silver-gray color with Scan-Guard™ Silicone Inserts	10" x 10" x 1.5" (25.4 cm x 25.4 cm x 3.8 cm)	8-10
2139-03	Silver-gray color Full Scan-Guard™ silicone mat on base, partial mat on cover to secure small instruments	10" x 15" x 1.5" (25.4 cm x 38 cm x 3.8 cm)	20+ or 7 VATS / MIS Instruments
2140-03	Silver-gray color with Scan-Guard™ Silicone Inserts	10" x 15" x 1.5" (25.4 cm x 38 cm x 3.8 cm)	10-12
2141-03	Silver-gray color, base with accessory compartment, additional tray insert, with Scan-Guard™ Silicone Inserts	10" x 15" x 2.6" (25.4 cm x 38 cm x 6.6 cm)	15+
2142-03	Silver-gray color, Scan-Guard™ silicone insert across full width of base, additional tray insert	10" x 15" x 2.6" (25.4 cm x 38 cm x 6.6 cm)	18+

All trays are steam, Immediate Use Steam Sterilization (IUSS) and ETO sterilization compatible
Firm Sale – May be available for evaluation



2083-01



2083-02



2083-03



2083-05



2081-11



2082-10



2081-21



SCANLAN®
V.I.P.™ Sterilization Trays
 Plastic Sterilization Trays, Scan-Guard™ Silicone Mat

Cat. No.	Description	Capacity
2083-01	6" x 2" x 0.7" (15 cm x 5.1 cm x 1.8 cm)	1-2
2083-02	6" x 3" x 0.7" (15 cm x 7.6 cm x 1.8 cm)	3
2083-03	7.8" x 3" x 0.7" (19.8 cm x 7.6 cm x 1.8 cm)	3
2083-05	9.6" x 5.5" x 0.7" (24.4 cm x 14 cm x 1.8 cm)	5-10
2081-11	10" x 6" x 0.7" (25.4 cm x 15 cm x 1.8 cm)	6-10
2082-10	10" x 6" x 1.5" (25.4 cm x 15 cm x 3.8 cm)	6-10
2081-21	additional tray insert with Scan-Guard™ silicone mat 10" x 6" x 1.5" (25.4 cm x 15 cm x 3.8 cm)	10+

All trays are steam, Immediate Use Steam Sterilization (IUSS) and ETO sterilization compatible
 Firm Sale - May be available for evaluation

V.I.P.™ Sterilization Trays (Valued Instrument Protection) | Plastic

INSTRUMENT CARE

2081-12



2082-20



2081-24



2084-20



SCANLAN®

V.I.P.™ Sterilization Trays

Plastic Sterilization Trays, Scan-Guard™ Silicone Mat

Cat. No.	Description	Capacity
2081-12	Plastic clasps, 15" x 10" x 0.7" (38 cm x 25.4 cm x 1.8 cm)	10-15
2082-20	Plastic clasps, deep base 15" x 10" x 1.5" (38 cm x 25.4 cm x 3.8 cm)	10-15
2081-24	Plastic clasps, additional tray insert and Scan-Guard™ silicone mats 15" x 10" x 1.5" (38 cm x 25.4 cm x 3.8 cm)	20-30
2084-20	Metal clasps, additional tray insert and Scan-Guard™ silicone mats 17.8" x 9.7" x 1.5" (45.2 cm x 25 cm x 3.8 cm)	24-30+

All trays are steam, Immediate Use Steam Sterilization (IUSS) and ETO sterilization compatible
Firm Sale - May be available for evaluation



INSTRUMENT CARE

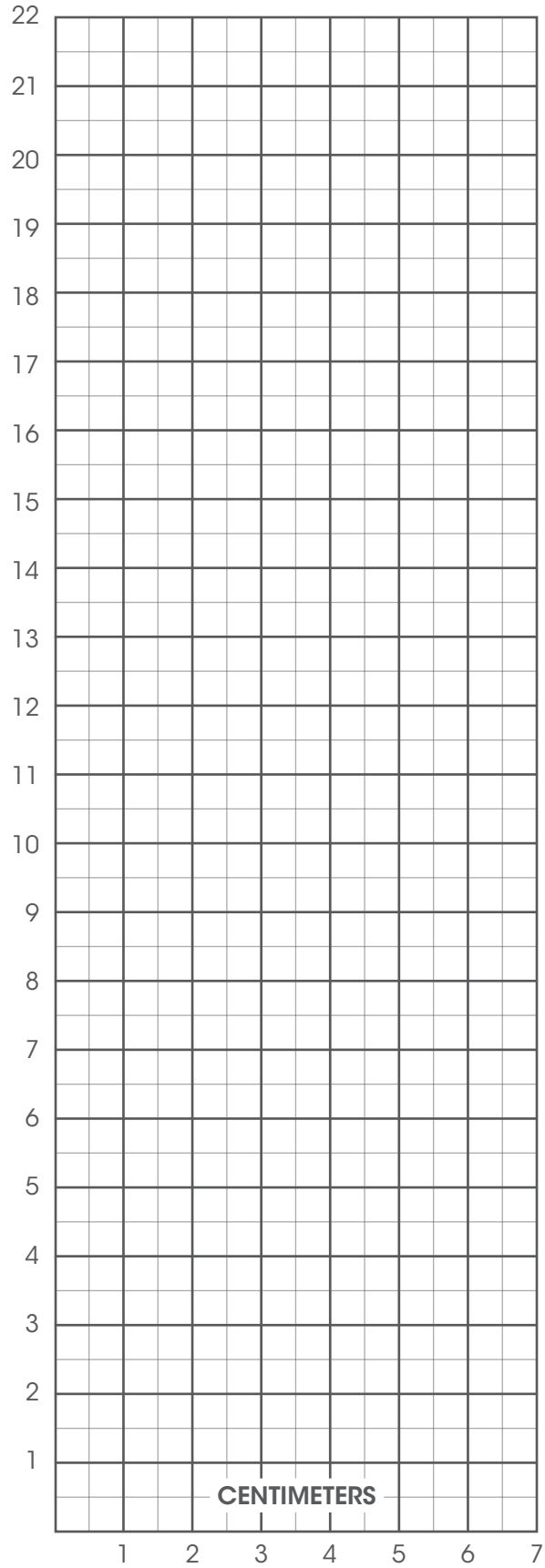
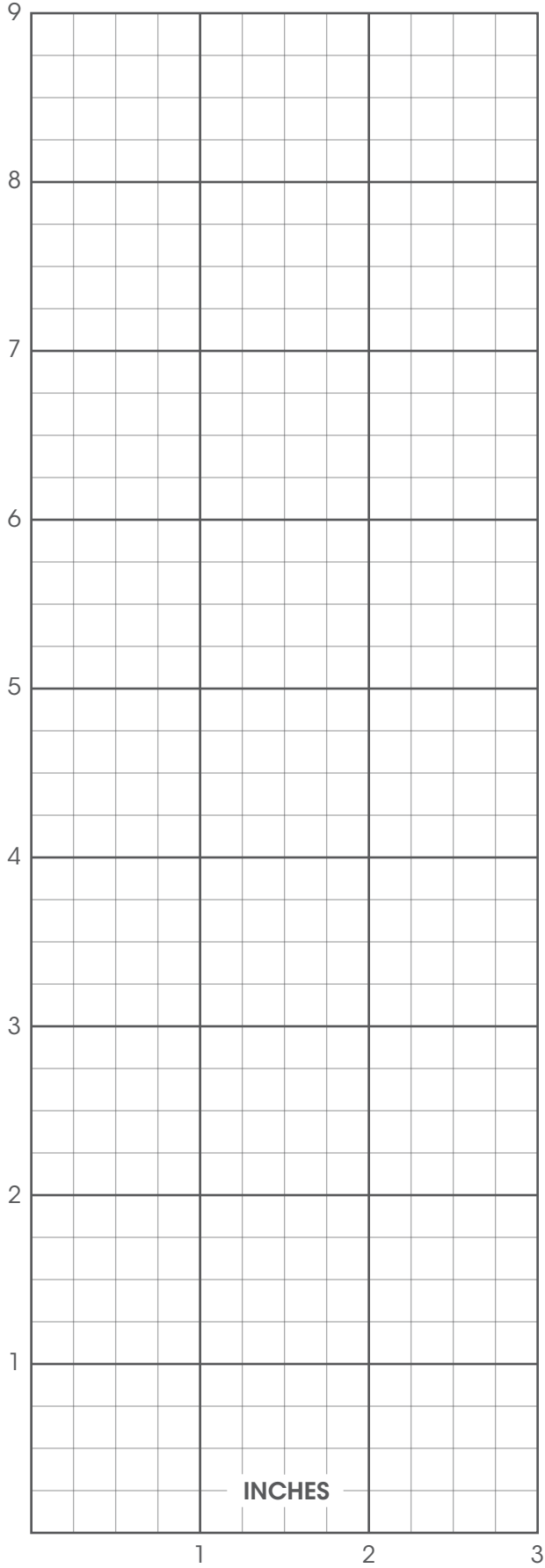

SURGICAL SKIN MARKERS 10.1

AORTA / VEIN PUNCHES 10.2

GRAFT MARKERS 10.3

VASCULAR TUNNELING

 Vascular Tunneling System 10.4

 Vascular Tunneling Set 10.6

VASCU-STATT® BULLDOG CLAMP SYSTEM

 VASCU-STATT® Micro Single-Use Clamps 10.8

 VASCU-STATT® Single-Use Clamps 10.9

 VASCU-STATT® II Single-Use Clamps 10.9

 VASCU-STATT® PLUS 10.9

 VASCU-STATT® II PLUS 10.9

 VASCU-STATT® PLUS Approximator 10.10

 VASCU-STATT® II PLUS Approximator 10.10

 VASCU-STATT® Approximator 10.10

 VASCU-STATT® II Approximator 10.10

 VASCU-STATT® Appliers 10.11



SILICONE LOOPS

 SURG-I-LOOP® Silicone Loops 10.12

 SURG-I-LOOP® PLUS 10.12

CLAMP AND JAW COVERS 10.13

SUTURE BOOTS 10.14

SUTURE TAGS 10.14

PIN PROTECTORS 10.15

VEIN HOLDER 10.15



SINGLE-USE

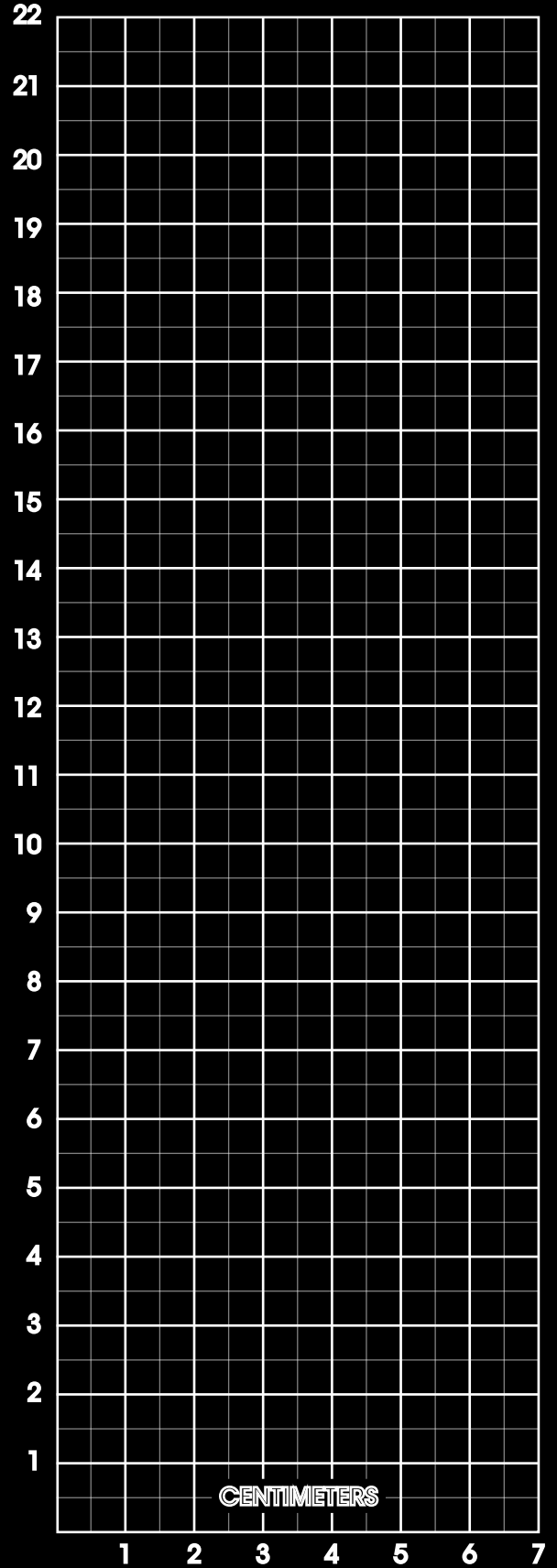
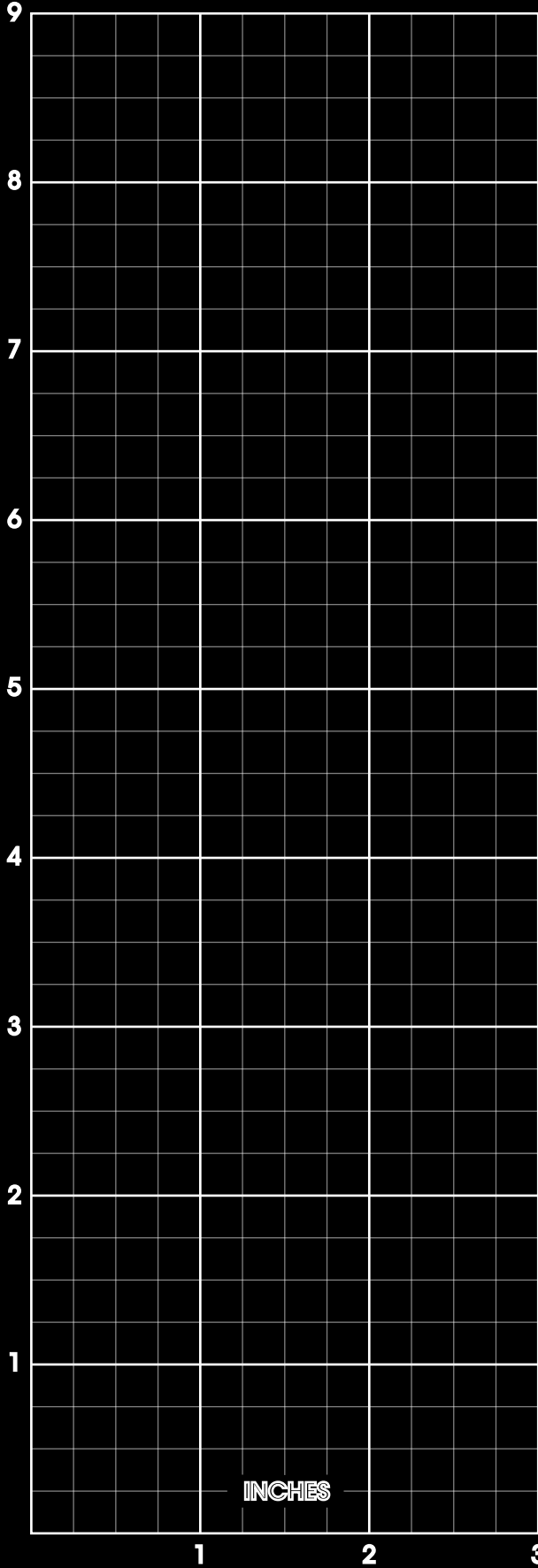

SCANLAN®
PrepMARK™ Surgical Skin Marker

SCANLAN® PrepMARK™ Surgical Skin Marker - Answers the need for a prep resistant skin marker. Its unique ink formula is resistant to pre-operative scrubbing with common alcohol-based skin preparation antiseptics.

SCANLAN® PrepMARK™ offers several advantages, including...

- **Clear and reliable marking** as recommended by the Joint Commission Protocol for Correct Site Marking
- **Vibrant color** – gentian violet
- **Prep resistant** ink is not altered by common alcohol-based antiseptics
- **Available in sterile and non-sterile**
- **Ruler** (inch and centimeter) to assist and support in the marking process
- **Regular tip** – provides a bold (0.04" / 1 mm) marking
- **Not made with natural rubber latex**



Available in gentian violet with regular tip, SCANLAN® PrepMARK™ surgical skin markers are made with a unique prep resistant ink and ideal for marking, identifying, coding, and contouring the surgical area.



Regular
Tip

Cat. No.	Description
1001-730	PrepMARK™ Surgical Skin Marker, Sterile, plus ruler, Box of 50 1 per sterile package with ruler, 50 per box
1001-731	PrepMARK™ Surgical Skin Marker, Non-Sterile, Container of 50

SCANLAN®
SURGICAL SKIN MARKERS

Available in gentian violet with both regular and extra fine tips, SCANLAN® surgical skin markers are appropriate for marking, identifying, coding, and contouring the surgical area. Not made with natural rubber latex.

Regular
Tip

Cat. No.	Description
1001-710	Gentian Violet

1 per sterile package with ruler,
5 packages per box



SINGLE-USE

SCANLAN® Aorta / Vein Punches

Precisely engineered Scissor Cut™ blades featured on SCANLAN® single-use aorta/vein punches provide clean accurate incisions for myocardial revascularization. With large finger rings for greater control and accuracy, and tapered tips for an unobstructed view of the operating field, SCANLAN® single-use aorta/vein punches are available in two lengths (Original and Ultimate™), two styles (round and elliptical), and nine cutting sizes. Radiopaque. Not made with natural rubber latex.



SCANLAN®
Original Aorta / Vein Punches



SCANLAN®
Ultimate Aorta / Vein Punches

Cat. No.	Hole Size	Total Length
1001-600	● 2.7 mm	5 3/4" (14.6 cm)
1001-601	● 3.5 mm	
1001-602	● 4.0 mm	
1001-604	● 4.5 mm	
1001-605	● 5.0 mm	
1001-606	● 5.5 mm	
1001-607	● 6.0 mm	
1001-608	● 2.0 x 4.0 mm	
1001-610	● 2.0 x 6.0 mm	

1 per sterile package, 5 packages per box

Cat. No.	Hole Size	Total Length
1001-620	● 2.7 mm	7 1/2" (19 mm)
1001-621	● 3.5 mm	
1001-622	● 4.0 mm	
1001-624	● 4.5 mm	
1001-626	● 5.0 mm	
1001-628	● 5.5 mm	
1001-629	● 6.0 mm	
1001-609	● 2.0 x 4.0 mm	
1001-611	● 2.0 x 6.0 mm	

1 per sterile package, 5 packages per box

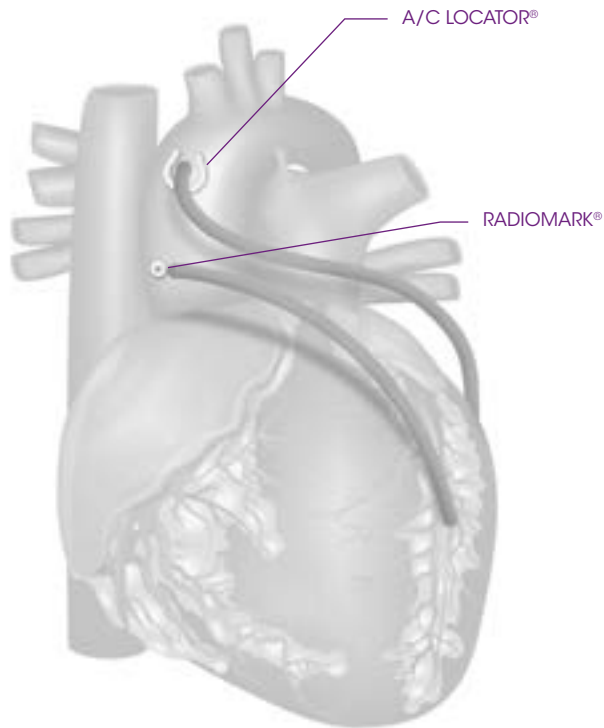

SCANLAN®
A/C LOCATOR® & RADIOMARK®

Scanlan offers two styles of single-use graft markers. U-shaped A/C LOCATOR® graft markers help to assess graft patency during postoperative cardiac angiography. RADIOMARK® graft markers are smaller, disk-shaped graft markers designed for use with peripheral and coronary grafts. Following graft placement, all graft markers can be applied using 5-0 or 6-0 sutures and will not migrate. SCANLAN® graft markers are flexible, lightweight, radiopaque and tissue-compatible to meet all implant criteria. Not made with natural rubber latex.



SCANLAN®
A/C Locator®

Cat. No. Description

1001-83	A/C LOCATOR® graft marker
---------	---------------------------

1 per sterile package, 10 packages per box



SCANLAN®
RADIOMARK®

Cat. No. Description

1001-831	RADIOMARK® graft marker
----------	-------------------------

1 per sterile package, 10 packages per box



SINGLE-USE

The SCANLAN® Vascular Tunneling System combines high quality grasping forceps with single-use tunneler sheaths for fast, accurate, atraumatic implantation of subcutaneous grafts.

SCANLAN®

Grasping Forceps

The grasping forceps features include . . .

- A choice of four styles:
Vascular Tuner Grasp Forceps (20.5" / 52 cm),
A/V Access Tuner Grasp Forceps (12" / 30.5 cm)
A/V Access Tuner Grasp Forceps - Partial Curve (12" / 30.5 cm)
A/V Access Tuner Grasp Forceps - Full Curve (12" / 30.5 cm)
- Each style will accommodate two sheath diameters (large or small)
- A knurled handle for positive control
- A handle indicator to verify tunneler curve direction
- Stainless steel construction, offering strength and long life, as well as quick, reliable, atraumatic graft placement
- Specially designed, stainless steel sterilization/storage case also available



Cat. No.	Grasping Forceps	Total Length
9009-24	Vascular Tuner	20.5" (52 cm)
9009-14	A/V Access Tuner	12" (30.5 cm)
9009-13	A/V Access Tuner - Partial Curve	12" (30.5 cm)
9009-15	A/V Access Tuner - Full Curve	12" (30.5 cm)



SCANLAN®
Single-Use Sheaths

The single-use sheath features include . . .

- Two sheath diameters (Large and Small) designed to fit each forceps style
- Allows atraumatic tunneling and placement of grafts without kinking, twisting, stretching, or pulling
- Smooth polymer sheaths and bullet tips offer near frictionless graft placement, essential for many new graft surfaces
- Minimal sheath diameters avoid excessive tissue disruption
- Color-coding provides easy length and diameter identification
- Radiopaque
- Not made with natural rubber latex

Cat. No.	Single-Use Sheaths For Grafts Up To		Interior Diameter	Total Length
9009-16	10 mm		12	20.5" (52 cm)
9009-18	8 mm		9.5	
9009-20	8 mm		9	12" (30.5 cm)
9009-22	6 mm		7	
9009-20	8 mm		9	12" (30.5 cm)
9009-22	6 mm		7	
9009-21	8 mm		9	12" (30.5 cm)
9009-23	6 mm		7	

1 per sterile package, 5 packages per box



SINGLE-USE

Pictured
9009-11 with Instrument tray 2150-03

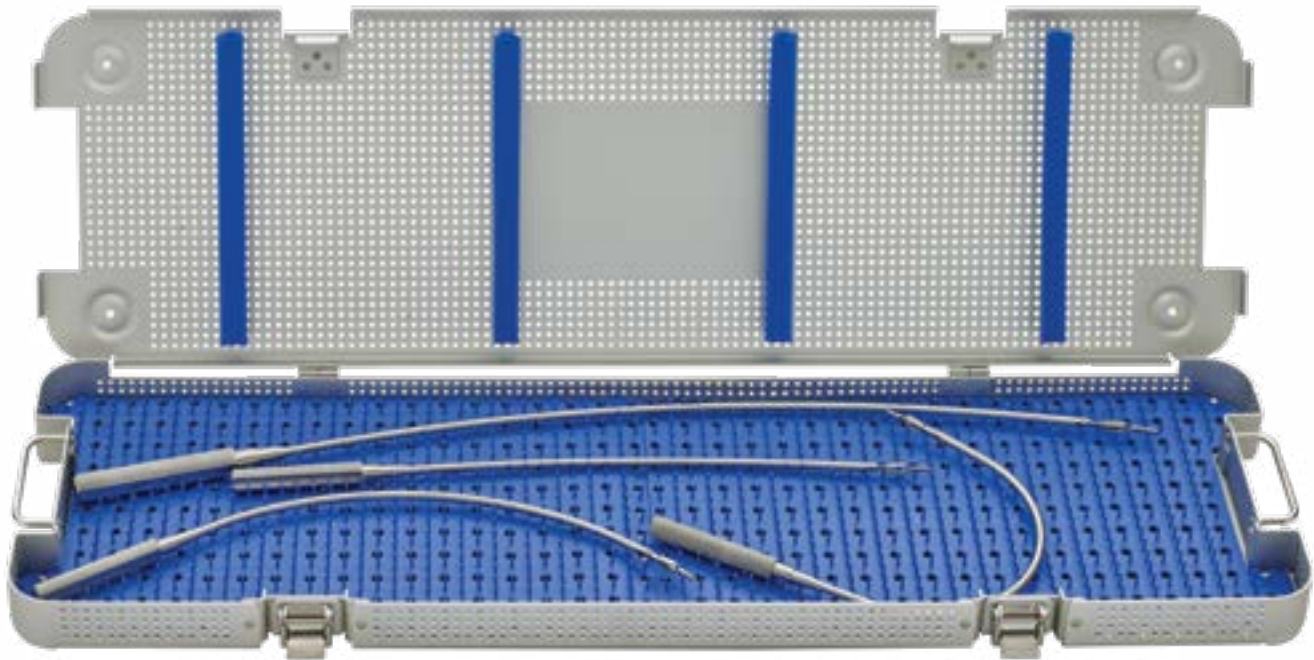

SCANLAN®

Vascular Tuner and A/V Access Tuner Grasp Set 9009-11

Qty.	Cat. No.	Description	Dimensions
1	9009-13	Partial Curve A/V Access Tuner	12" (30.5 cm)
1	9009-14	A/V Access Tuner	12" (30.5 cm)
1	9009-15	Full Curve A/V Access Tuner	12" (30.5 cm)
1	9009-24	Vascular Tuner	20.5" (52 cm)
1	2150-03	SCANLAN® V.I.P.™ Storage / Sterilization Tray	29" x 8.4" x 1.5" (73.7 cm x 21.3 cm x 3.8 cm)

Set does not include tunneler sheaths
All trays are steam, IUSS, ETO and Plasma sterilization compatible
Firm Sale - May be available for evaluation

Pictured
 9009-10 with Instrument tray 9009-26

SINGLE-USE



SCANLAN®
**Vascular Tunneler and
 A/V Access Tunneler Grasping Forceps Set 9009-10**

Qty.	Cat. No.	Description	Dimensions
1	9009-14	A/V Access Tunneler	12" (30.5 cm)
1	9009-24	Vascular Tunneler	20.5" (52 cm)
1	9009-26	SCANLAN® V.I.P.™ Storage / Sterilization Tray	3.5" x 26" x 1.5" (8.9 cm x 66 cm x 3.8 cm)

SCANLAN®
**Vascular Tunneler and
 A/V Access Tunneler Grasping Forceps Set 9009-12**

Qty.	Cat. No.	Description	Dimensions
1	9009-24	Vascular Tunneler	20.5" (52 cm)
1	9009-26	SCANLAN® V.I.P.™ Storage / Sterilization Tray	3.5" x 26" x 1.5" (8.9 cm x 66 cm x 3.8 cm)

Set does not include tunneler sheaths
 All trays are steam, IUSS, ETO and Plasma sterilization compatible
 Firm Sale - May be available for evaluation



SINGLE-USE

SCANLAN®

VASCU-STATT®

Single-Use Bulldog Clamps

Vascu-Stat® single-use bulldog clamps are a lightweight, cost-effective alternative to metal bulldog clamps.

- Angled and straight designs
- Variety of clamping pressures
- Color coded for easy identification
- Atraumatic jaws
- Apply by hand or with Scanlan Vascu-Stat® applicators
- Radiopaque
- Not made with natural rubber latex

Vascu-Stat® bulldog clamps feature a consistent pre-set tension unlike metal bulldog clamps where pressure can weaken after repeated use.



SCANLAN®

VASCU-STATT® System

Vascu-Stat®

Original bulldog clamp design

Vascu-Stat® II

Firmer clamping pressure than original Vascu-Stat®

Vascu-Stat® Plus

Vascu-Stat® PLUS single-use bulldog clamps offer the same benefits as the Vascu-Stat® original clamps, but features a cushioned Gentle Jaw™ surface that absorbs and softens as it provides an atraumatic occlusion of the vessel.

Vascu-Stat® Micro

Micro Vascu-Stat® clamps offer even smaller clamp sizes – preferred for use in peripheral micro vascular and neuro surgery, as well as in many types of plastic and hand surgery.

Micro Vascu-Stat® single-use bulldog clamps also offer a radiopaque tag line for safe and easy visualization within the operating field.

SCANLAN®

Micro VASCU-STATT®

One size, available with straight jaws. Color-coded Purple (micro, regular clamping pressure).

Clamping Pressure REGULAR		Micro Vascu-Stat®	
		1001-499	Micro straight (purple)

SCANLAN®

Micro VASCU-STATT® II

One size, available with straight jaws. Color-coded Black (micro, firm clamping pressure).

Clamping Pressure FIRM		Micro Vascu-Stat® II	
		1001-529	Micro straight (black)

2 each per sterile package, 5 packages per box

SCANLAN®
VASCU-STATT® and VASCU-STATT® Plus

Three sizes, available with straight or angled jaws.
Color-coded. Regular Clamping Pressure.

Clamping Pressure REGULAR		Vascu-Stat®	
		1001-502	Mini, straight (red)
		1001-503	Mini, angled 45° (red)
		Vascu-Stat® Plus	
		1001-552	Mini, straight (red)
		1001-553	Mini, angled 45° (red)

SCANLAN®
VASCU-STATT® II and VASCU-STATT® II Plus

Three sizes, available with straight or angled jaws.
Color-coded. Firm Clamping Pressure.

Clamping Pressure FIRM		Vascu-Stat® II	
		1001-530	Mini, straight (green)
		1001-531	Mini, angled 45° (green)
		Vascu-Stat® II Plus	
		1001-570	Mini, straight (green)
		1001-571	Mini, angled 45° (green)

Clamping Pressure REGULAR		Vascu-Stat®	
		1001-500	Midi, straight (white)
		1001-501	Midi, angled 45° (white)
		Vascu-Stat® Plus	
		1001-550	Midi straight (white)
		1001-551	Midi, angled 45° (white)

Clamping Pressure FIRM		Vascu-Stat® II	
		1001-532	Midi, straight (yellow)
		1001-533	Midi, angled 45° (yellow)
		Vascu-Stat® II Plus	
		1001-572	Midi, straight (yellow)
		1001-573	Midi, angled 45° (yellow)

Clamping Pressure REGULAR		Vascu-Stat®	
		1001-504	Maxi, straight (blue)
		1001-505	Maxi, angled 45° (blue)
		Vascu-Stat® Plus	
		1001-554	Maxi straight (blue)
		1001-555	Maxi, angled 45° (blue)

Clamping Pressure FIRM		Vascu-Stat® II	
		1001-534	Maxi, straight (orange)
		1001-535	Maxi, angled 45° (orange)
		Vascu-Stat® II Plus	
		1001-574	Maxi, straight (orange)
		1001-575	Maxi, angled 45° (orange)

2 per sterile package, 5 packages per box



SCANLAN®
Vascu-Stat® Approximator & Vascu-Stat® Plus Approximator

Used to facilitate end-to-end anastomosis. Three sizes, available with straight or angled jaws. Color-coded. Regular Clamping Pressure.

Clamping Pressure REGULAR		Vascu-Stat® Approximator	
		1001-507	Mini, straight (red)
		1001-508	Mini, angled 45° (red)
		Vascu-Stat® Plus Approximator	
		1001-560	Mini, straight (red)
		1001-561	Mini, angled 45° (red)
Not Shown Actual Size			

SCANLAN®
Vascu-Stat® II Approximator & Vascu-Stat® II Plus Approximator

Used to facilitate end-to-end anastomosis. Three sizes, available with straight or angled jaws. Color-coded. Firm Clamping Pressure.

Clamping Pressure FIRM		Vascu-Stat® II Approximator	
		1001-540	Mini, straight (green)
		1001-541	Mini, angled 45° (green)
		Vascu-Stat® II Plus Approximator	
		1001-580	Mini, straight (green)
		1001-581	Mini, angled 45° (green)
Not Shown Actual Size			

Clamping Pressure REGULAR		Vascu-Stat® Approximator	
		1001-509	Midi, straight (white)
		1001-510	Midi, angled 45° (white)
		Vascu-Stat® Plus Approximator	
		1001-562	Midi straight (white)
		1001-563	Midi, angled 45° (white)
Not Shown Actual Size			

Clamping Pressure FIRM		Vascu-Stat® II Approximator	
		1001-542	Midi, straight (yellow)
		1001-543	Midi, angled 45° (yellow)
		Vascu-Stat® II Plus Approximator	
		1001-582	Midi, straight (yellow)
		1001-583	Midi, angled 45° (yellow)
Not Shown Actual Size			

Clamping Pressure REGULAR		Vascu-Stat® Approximator	
		1001-511	Maxi, straight (blue)
		1001-512	Maxi, angled 45° (blue)
		Vascu-Stat® Plus Approximator	
		1001-564	Maxi straight (blue)
		1001-565	Maxi, angled 45° (blue)
Not Shown Actual Size			

Clamping Pressure FIRM		Vascu-Stat® II Approximator	
		1001-544	Maxi, straight (orange)
		1001-545	Maxi, angled 45° (orange)
		Vascu-Stat® II Plus Approximator	
		1001-584	Maxi, straight (orange)
		1001-585	Maxi, angled 45° (orange)
Not Shown Actual Size			

1 per sterile package. 5 packages per box

SCANLAN®

VASCU-STATT® Appliers

Vascu-Stat® appliers are designed to be used exclusively with Vascu-Stat® single-use bulldog clamps. They are a convenient, easy way to apply Vascu-Stat® single-use bulldog clamps — especially in deep, hard to reach surgical fields.

Cat. No.	Description	Dimensions
1001-506	VASCU-STATT® Applier, Straight	8 1/2" (21.5 cm)
1001-506A	VASCU-STATT® Applier, Angled	8 1/2" (21.5 cm)
1001-506M	Micro VASCU-STATT® Applier, Straight	8 1/2" (21.5 cm)
9009-506	VASCU-STATT® Applier, Straight	15 1/2" (39.4 cm)
9009-506A	VASCU-STATT® Applier, Angled	15 1/2" (39.4 cm)



1001-506
VASCU-STATT®
Applier, Straight



1001-506A
VASCU-STATT®
Applier, Curved



1001-506M
Micro VASCU-STATT®
Applier, Straight



9009-506
CardioVasive™
VASCU-STATT®
Applier, Straight



9009-506A
CardioVasive™
VASCU-STATT®
Applier, Curved



SINGLE-USE

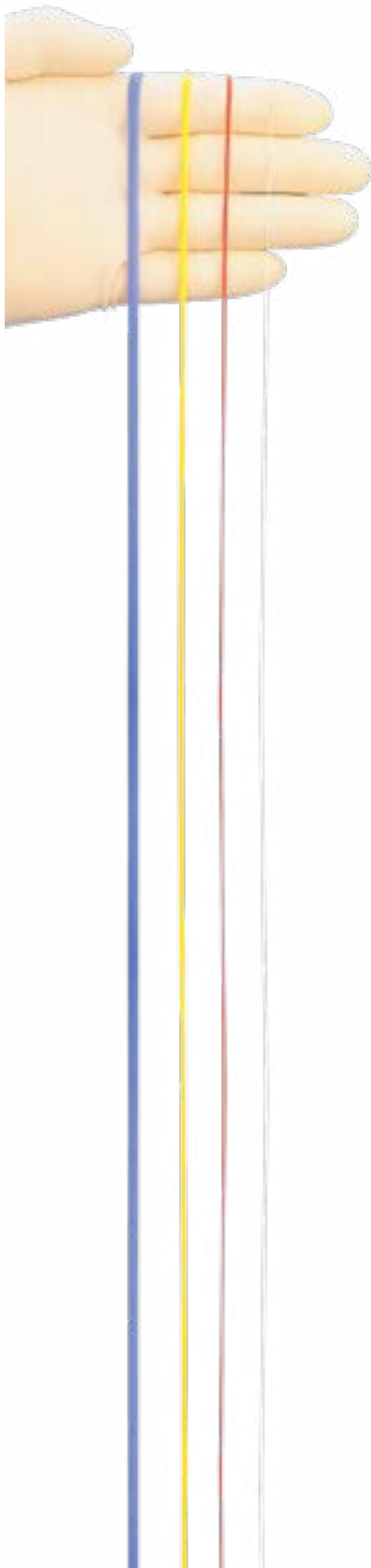

SCANLAN®
SURG-I-LOOP®

Vessel Loops

Designed to assist surgeons in complicated surgical fields by providing retraction, occlusion and identification of arteries, veins, nerves and ureters.

- **Unique design** – provides access to complicated surgical fields
- **Versatile** – can retract and occlude arteries, veins, nerves and ureters
- **Durable** – retains preset tension
- **Radiopaque**
- **Not made with natural rubber latex**

Cat. No.	Description	Color	Dimensions	Length
1001-78A	Super Maxi	Blue	5 mm x 1.3 mm	16 1/2" (42 cm)
1001-76	Maxi	Red	2.5 mm x 1.0 mm	
1001-82		White		
1001-78		Blue		
1001-80		Yellow		
1001-75	Mini	Red	1.5 mm x 0.9 mm	
1001-81		White		
1001-77		Blue		
1001-79		Yellow		
1001-81M	Micro	White	0.5 mm x 0.3 mm	

2 per sterile package, 10 packages per box

SCANLAN®
SURG-I-LOOP® Plus

Vessel Loops

SURG-I-LOOP® Plus features a solid stainless steel tip for fast, accurate placement / passing in complicated surgical fields. Ideal for minimally-invasive cardiac surgery. Radiopaque. Not made with natural rubber latex.

Cat. No.	Description	Color	Dimensions	Length
1001-81P	Blunt Needle	Light Green	1.2 mm	14 3/4" (37 cm)
1001-82P	Semi-Sharp Needle	Light Orange	1.2 mm	

2 per sterile package, 10 packages per box

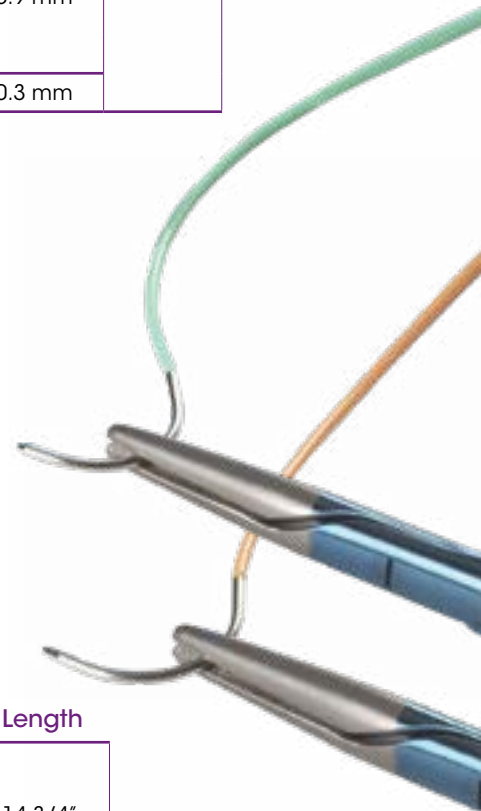



SCANLAN®
SOFT-GRIP™
Fabric Jaw Covers

Special foam and fabric combination provides a soft, non-slip clamp surface.

- **Special material** – assures no fibrous residue in operating field
- **Versatile** – designed to fit a variety of instruments
- **Ease of application** – designed with convenient pull tabs
- **Adaptable** - may be trimmed to desired length
- **Radiopaque**
- **Not made with natural rubber latex**

Cat. No.	Description	Length	Width
1001-740	SOFT-GRIP™ Fabric Clamp Covers	5" (127 cm)	3/8" (9.5 mm)

2 per sterile package, 10 packages per box



SCANLAN®
SURG-I-PAW®
Instrument Jaw Covers

Designed for Intestinal, Thoracic, Pediatric, and other specialty types of surgery.

- **Atraumatic** – converts standard clamps into atraumatic instruments
- **Deep serrations** – provides firm, atraumatic occlusion
- **Contoured design** – provides secure pressure - will not slip or twist
- **Radiopaque**
- **Not made with natural rubber latex**

Cat. No.	Description	Size
1001-72	SURG-I-PAW™ Red	1/10" (2.5 mm)
1001-73	SURG-I-PAW™ White	2/10" (5.0 mm)
1001-74	SURG-I-PAW™ Blue	3/10" (7.5 mm)

2 per sterile package, 10 packages per box

SINGLE-USE

SCANLAN®
SUTURE BOOT™

Instrument Jaw Covers

Designed to facilitate the grasping and tagging of suture.

- **Atraumatic** – firmly holds the finest suture without damage
- **Secure** – will not slip
- **Color coded** – bright yellow and pink for immediate identification
- **Foam cartridge** – designed for fast / easy access
- **Radiopaque**
- **Not made with natural rubber latex**

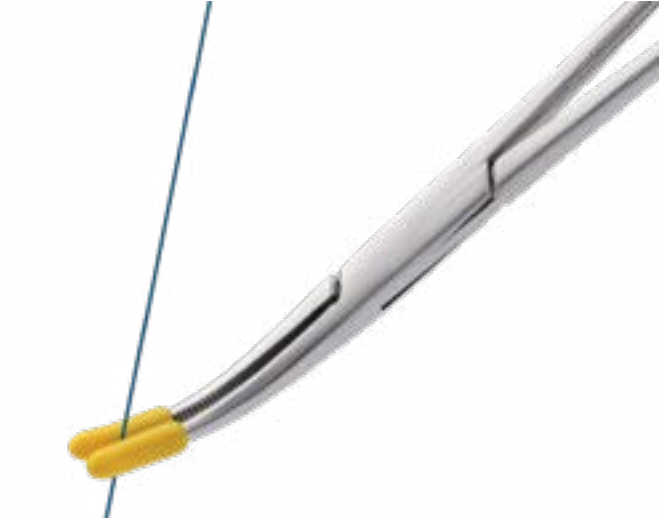

Cat. No.	Description	Color	QTY per Cartridge
1001-513	Original Mini	Yellow	3 Pair
1001-514	Original Standard		5 Pair
1001-515	Large Mini	Pink	3 Pair
1001-516	Large Standard		5 Pair

1 per sterile package, 5 packages per box

SCANLAN®
Suture Tag

SCANLAN®
SUTURE-STATT™

Suture Tags

Designed to facilitate the grasping and tagging of suture during ophthalmic or delicate procedures.

- **Secure** – firmly holds the finest suture without damage
- **Keeps sutures out of the operative field**
- **Lightweight** – only 0.5 grams
- **Radiopaque**
- **Not made with natural rubber latex**



Cat. No.	Description
1001-520	Suture Tags

2 per sterile package, 5 packages per box

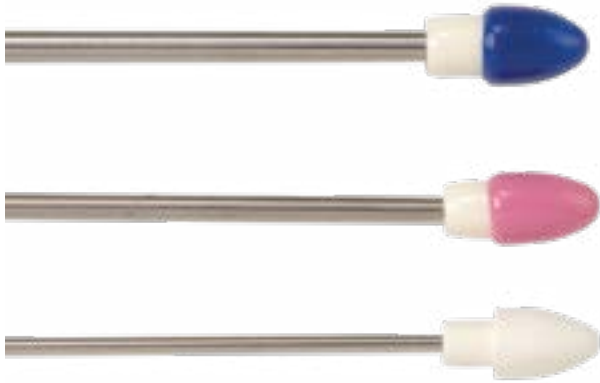

SCANLAN®
PINCAP®

Orthopedic Pin Protectors

Unique single-use protective covers for exposed tips of orthopedic pins and wires.

- **Unique design** – provides excellent protection from dermal abrasions, damage to bedding, clothing snags, and surgical glove snags
- **Size selection** – designed to fit most common pins and wires
- **Double-wall design** – provides additional protection
- **Color coded** – providing easy identification
- **Radiopaque**
- **Not made with natural rubber latex**

Cat. No.	Description	Fits K-Wire Size
301-0110	White	0.028" (0.71 mm)
		0.035" (0.89 mm)
		0.045" (1.14 mm)
301-0120	Pink and White	0.062" (1.57 mm)
301-0130	Blue and White	0.078" (5/64") (1.98 mm)

2 per sterile package, 20 packages per box

SCANLAN®
Vein Holders



SCANLAN®
SOLEM™ Vein Holder

Ideal for assisting surgeons during vessel anastomosis, the SCANLAN® Solem™ vein holder gently yet firmly grasps vein grafts and precisely positions suture without trauma. Its slim profile and concave tip assures optimal exposure and the lightly serrated clip provides steady, consistent pressure, minimizing graft movement.

- **Radiopaque**
- **Not made with natural rubber latex**

Cat. No.	Description	Dimensions
1001-760	Solem™ Vein Holder	6-1/2" (16.5 cm)

1 per sterile package, 5 packages per box



SINGLE-USE

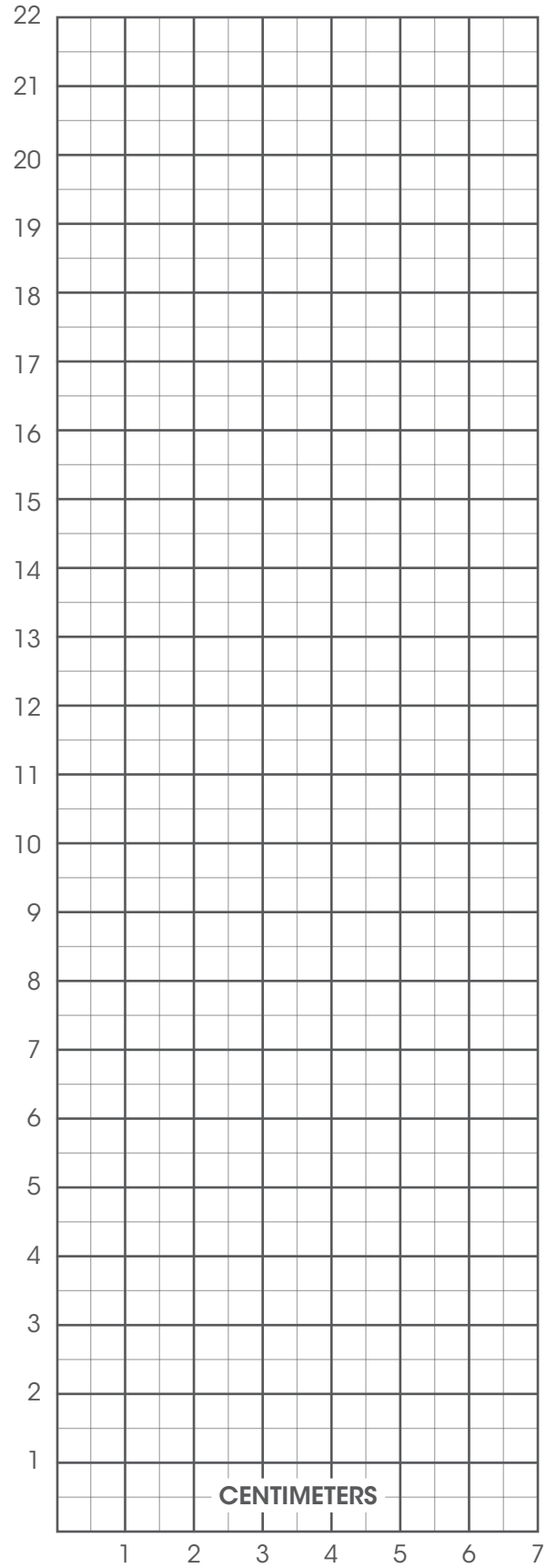
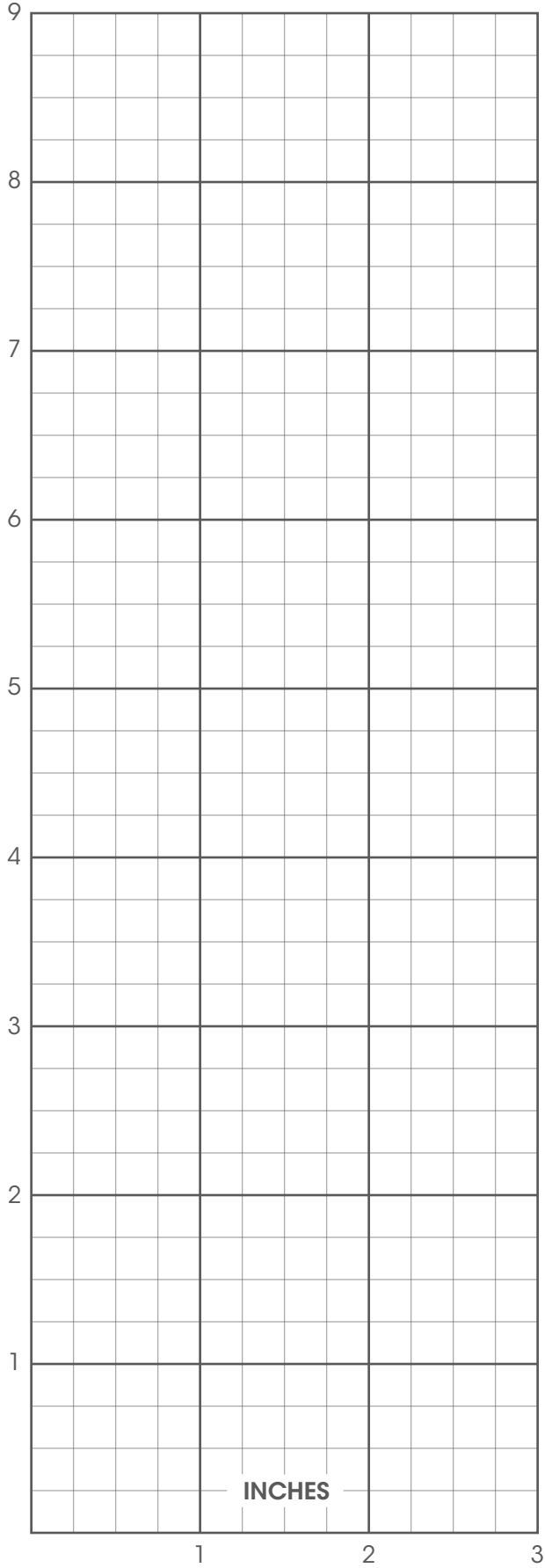



INDEX



1001-04	6.16	1001-1063	9.2
1001-05	6.16	1001-1064	9.2
1001-10	6.17	1001-1065	9.2
1001-1000	9.2	1001-1066	9.2
1001-1001	9.2	1001-1067	9.2
1001-1002	9.2	1001-1068	9.2
1001-1003	9.2	1001-1069	9.2
1001-1004	9.2	1001-1070	9.2
1001-1005	9.2	1001-1071	9.2
1001-1006	9.2	1001-1072	9.2
1001-1007	9.2	1001-1073	9.2
1001-1008	9.2	1001-1074	9.2
1001-1009	9.2	1001-1075	9.2
1001-1010	9.2	1001-1076	9.2
1001-1011	9.2	1001-1077	9.2
1001-1012	9.2	1001-1078	9.2
1001-1013	9.2	1001-1079	9.2
1001-1014	9.2	1001-1080	9.2
1001-1015	9.2	1001-1081	9.2
1001-1016	9.2	1001-1082	9.2
1001-1017	9.2	1001-1083	9.2
1001-1018	9.2	1001-1098	9.4
1001-1019	9.2	1001-1099	9.4
1001-1020	9.2	1001-11	6.17
1001-1021	9.2	1001-1100	9.4
1001-1022	9.2	1001-1101	9.4
1001-1023	9.2	1001-1102	9.4
1001-1024	9.2	1001-1103	9.4
1001-1025	9.2	1001-1104	9.4
1001-1026	9.2	1001-1105	9.4
1001-1027	9.2	1001-1106	9.4
1001-1028	9.2	1001-1107	9.4
1001-1041	9.2	1001-1108	9.4
1001-1042	9.2	1001-1109	9.4
1001-1043	9.2	1001-1110	9.4
1001-1044	9.2	1001-1111	9.4
1001-1045	9.2	1001-1112	9.4
1001-1046	9.2	1001-1113	9.4
1001-1047	9.2	1001-1114	9.4
1001-1048	9.2	1001-1115	9.4
1001-1049	9.2	1001-1116	9.4
1001-1050	9.2	1001-1117	9.4
1001-1051	9.2	1001-1118	9.4
1001-1052	9.2	1001-1119	9.4
1001-1053	9.2	1001-1120	9.4
1001-1054	9.2	1001-1121	9.4
1001-1055	9.2	1001-1122	9.4
1001-1056	9.2	1001-1123	9.4
1001-1057	9.2	1001-1124	9.4
1001-1058	9.2	1001-1125	9.4
1001-1059	9.2	1001-12	6.17
1001-1060	9.2	1001-13	6.17
1001-1061	9.2	1001-14	6.17
1001-1062	9.2	1001-200	9.11



INDEX

1001-201	9.11	1001-530	10.9
1001-202	9.11	1001-531	10.9
1001-203	9.11	1001-532	10.9
1001-204	9.11	1001-533	10.9
1001-205	9.11	1001-534	10.9
1001-206	9.11	1001-535	10.9
1001-207	9.11	1001-54	2.56
1001-208	9.11	1001-540	10.10
1001-209	9.11	1001-541	10.10
1001-21	5.40	1001-542	10.10
1001-23	5.40	1001-543	10.10
1001-300	9.11	1001-544	10.10
1001-301	9.11	1001-545	10.10
1001-302	9.11	1001-550	6.46, 10.9
1001-303	9.11	1001-551	10.9
1001-304	9.11	1001-552	10.9
1001-305	9.11	1001-553	10.9
1001-306	9.11	1001-554	10.9
1001-307	9.11	1001-555	10.9
1001-308	9.11	1001-560	10.10
1001-309	9.11	1001-561	10.10
1001-400	9.11	1001-562	10.10
1001-401	9.11	1001-563	10.10
1001-402	9.11	1001-564	10.10
1001-403	9.11	1001-565	10.10
1001-404	9.11	1001-570	10.9
1001-405	9.11	1001-571	10.9
1001-406	9.11	1001-572	10.9
1001-407	9.11	1001-573	10.9
1001-408	9.11	1001-574	10.9
1001-409	9.11	1001-575	10.9
1001-49	9.1	1001-580	10.10
1001-499	10.8	1001-581	10.10
1001-500	10.9	1001-582	10.10
1001-501	10.9	1001-583	10.10
1001-502	10.9	1001-584	10.10
1001-503	10.9	1001-585	10.10
1001-504	10.9	1001-59	9.1
1001-505	10.9	1001-60	9.1
1001-506	6.46, 10.11	1001-600	10.2
1001-506A	10.11	1001-601	10.2
1001-506M	10.11	1001-602	10.2
1001-507	10.10	1001-604	10.2
1001-508	10.10	1001-605	10.2
1001-509	10.10	1001-606	10.2
1001-510	10.10	1001-607	10.2
1001-511	10.10	1001-608	10.2
1001-512	10.10	1001-609	10.2
1001-513	10.14	1001-61	9.1
1001-514	10.14	1001-610	10.2
1001-515	10.14	1001-611	10.2
1001-516	10.14	1001-620	10.2
1001-520	10.14	1001-621	10.2
1001-529	10.8	1001-622	10.2



1001-624	10.2	1001-811	9.3
1001-626	10.2	1001-812	9.3
1001-628	10.2	1001-813	9.3
1001-629	10.2	1001-814	9.3
1001-630	9.1	1001-815	9.3
1001-631	9.1	1001-816	9.3
1001-632	9.1	1001-817	9.3
1001-633	9.1	1001-818	9.3
1001-634	9.1	1001-819	9.3
1001-635	9.1	1001-81M	10.12
1001-636	9.1	1001-81P	10.12
1001-637	9.1	1001-82	10.12
1001-638	9.1	1001-820	9.3
1001-639	9.1	1001-821	9.3
1001-64	9.1	1001-822	9.3
1001-640	9.1	1001-823	9.3
1001-641	9.1	1001-824	9.3
1001-642	9.1	1001-825	9.3
1001-643	9.1	1001-82P	10.12
1001-65	9.1	1001-83	10.3
1001-66	9.1	1001-831	10.3
1001-67	9.1	1001-84	9.11
1001-68	9.1	1001-85	9.11
1001-69	9.1	1001-86	9.11
1001-70	9.1	1001-87	9.11
1001-71	9.1	1001-88	9.11
1001-710	10.1	1001-89	9.11
1001-72	10.13	1001-90	9.11
1001-725	10.1	1001-904	9.5
1001-73	10.13	1001-904C	9.7
1001-730	10.1	1001-905	9.5
1001-731	10.1	1001-905C	9.7
1001-74	10.13	1001-906	9.5
1001-740	10.13	1001-906C	9.7
1001-75	10.12	1001-907	9.5
1001-76	6.46, 10.12	1001-907C	9.7
1001-760	10.15	1001-908	9.5
1001-77	10.12	1001-908C	9.7
1001-78	10.12	1001-909	9.5
1001-78A	10.12	1001-909C	9.7
1001-79	10.12	1001-91	9.11
1001-80	10.12	1001-910	9.5
1001-800	9.3	1001-910C	9.7
1001-801	9.3	1001-914	9.5
1001-802	9.3	1001-914C	9.7
1001-803	9.3	1001-915	9.5
1001-804	9.3	1001-915C	9.7
1001-805	9.3	1001-916	9.5
1001-806	9.3	1001-916C	9.7
1001-807	9.3	1001-917	9.5
1001-808	9.3	1001-917C	9.7
1001-809	9.3	1001-918	9.5
1001-81	10.12	1001-918C	9.7
1001-810	9.3	1001-919	9.5



INDEX

1001-919C	9.7	2002-22	2.42
1001-92	9.11	2002-229	2.21
1001-920	9.5	2002-23	2.36
1001-920C	9.7	2002-230	2.21
1001-921	9.6	2002-231	2.21
1001-922	9.6	2002-232	2.19
1001-923	9.6	2002-234	2.19
1001-924	9.6	2002-235	2.19, 6.42
1001-925	9.6	2002-236	2.20
1001-926	9.6	2002-238	2.20
1001-927	9.6	2002-240	2.18
1001-928	9.6	2002-242	2.18
1001-929	9.6	2002-244	2.18
1001-93	9.11	2002-246	2.18
1001-930	9.6	2002-248	2.22
1001-931	9.6	2002-250	2.22
1001-936	9.6	2002-28	2.38
1001-94	9.1	2002-280	2.31
1001-940	9.8	2002-282	2.31
1001-95	9.1	2002-286	2.31
1001-950	9.9	2002-30	2.38
1001-951	9.9	2002-32	2.39
1001-96	9.1	2002-33	2.36
1001-964	9.5	2002-34	2.39
1001-965	9.5	2002-36	2.39
1001-966	9.5	2002-38	2.37
1001-967	9.5	2002-40	2.37
1001-968	9.5	2002-42	2.35
1001-969	9.5	2002-43	2.36
1001-97	9.1	2002-44	2.41
1001-970	9.5	2002-46	2.41
1001-971	9.6	2002-48	2.41
1001-972	9.6	2002-50	2.41
1001-973	9.6	2002-51	2.36
1001-974	9.6	2002-52	2.37
1001-975	9.6	2002-54	2.43
1001-976	9.6	2002-62	2.27
1001-977	9.6	2002-64	2.27
1001-98	9.1	2002-66	2.28
1001-99	9.1	2002-70	2.27
2002-100	2.29	2002-72	2.28
2002-106	2.29	2002-76	2.35
2002-110	2.30	2002-78	2.25
2002-112	2.36	2002-80	2.32
2002-113	2.36	2002-82	2.32
2002-116	2.40	2002-86	2.33
2002-117	2.40	2002-88	2.33
2002-128	2.23	2002-90	2.25
2002-13	2.36	2002-92	2.26
2002-134	2.23	2002-94	2.26
2002-14	2.34	2002-96	2.26
2002-16	2.34	2081-11	6.57, 9.14
2002-184	2.24	2081-12	9.15
2002-186	2.24	2081-21	9.14



2081-23	6.47	3003-162	3.9
2081-24	9.15	3003-164	3.9, 6.50, 6.52
2082-10	9.14	3003-166	3.9
2082-20	9.15	3003-170	4.12
2083-01	9.14	3003-171	4.10
2083-02	9.14	3003-172	4.12
2083-03	9.14	3003-173	4.10
2083-05	9.14	3003-174	4.12
2084-20	9.15	3003-175	4.10
2133-03	6.3, 9.12	3003-177	4.10
2135-03	6.3, 9.12	3003-177-3	4.9, 6.53
2135-04	6.16	3003-177-4	4.9
2138-03	6.37, 6.39, 6.49, 6.51, 6.55, 6.59, 9.13	3003-180	4.12
2139-03	9.13	3003-181	4.10
2140-03	6.35, 6.51, 6.55, 9.13	3003-182	4.12
2141-03	6.51, 6.55, 9.13	3003-183	4.10
2142-03	6.47, 9.13	3003-184	4.12
2145-02	6.41	3003-185	4.10
2145-03	9.12	3003-187	4.10
2146-03	9.12	3003-190	4.12
2150-03	9.12, 10.6	3003-191	4.10
2151-03	6.23	3003-193	4.10
2160-03	8.6	3003-195	4.10
2161-03	8.7	3003-200	4.12
2162-03	8.8	3003-200-12	4.12
3003-02	3.17	3003-202	4.12
3003-03	3.17	3003-204	4.12
3003-04	3.17, 6.43	3003-207	4.15
3003-05	3.17, 6.43	3003-224	4.17
3003-051	3.16	3003-225	4.15
3003-06	3.17	3003-226	4.17
3003-07	3.17	3003-227	4.15
3003-071	3.16	3003-229	4.15
3003-09	3.18	3003-234	4.17
3003-150	3.11	3003-234-1	4.17, 6.43
3003-152	3.11	3003-235	4.16
3003-154	3.11	3003-236	4.17
3003-154-3	3.11, 6.50	3003-237	4.16
3003-154-4	3.11	3003-238	4.17
3003-156	3.11	3003-239	4.16
3003-156-3	3.11, 6.50	3003-243	4.16
3003-156-4	3.11	3003-261	4.15
3003-158	3.12	3003-263	4.15
3003-158-10	3.12	3003-265	4.15
3003-158-3	3.12, 6.52	3003-280	2.11
3003-158-4	3.12	3003-282	2.11
3003-158-8	3.12, 6.43	3003-286	2.11
3003-158-9	3.12	3003-332	4.7
3003-159	3.12	3003-334	4.7
3003-159-10	3.12	3003-336	4.7
3003-159-3	3.12, 6.52	3003-338	4.7
3003-159-4	3.12	3003-342	4.2
3003-159-8	3.12	3003-344	4.2
3003-160	3.9	3003-346	4.2



INDEX

3003-348	4.2	3003-56	2.5
3003-352	4.3	3003-570	4.18
3003-354	4.3	3003-580	4.18
3003-356	4.3	3003-59	2.7
3003-358	4.3	3003-610	2.3
3003-362	4.4	3003-611	2.3
3003-364	4.4	3003-612	2.3
3003-366	4.4	3003-613	2.2
3003-368	4.4	3003-614	2.2, 6.42
3003-372	4.5	3003-616	2.1
3003-374	4.5	3003-617	2.6
3003-376	4.5	3003-618	2.1
3003-378	4.5	3003-620	2.1
3003-381	4.2, 6.34	3003-628	2.4
3003-382	4.6	3003-630	2.4
3003-384	4.6	3003-632	2.3
3003-386	4.6	3003-633	2.2
3003-388	4.6	3003-634	2.2
3003-390	4.3, 6.34	3003-636	2.1
3003-391	4.2, 6.36	3003-637	2.1
3003-402	4.25	3003-638	2.1
3003-404	4.25	3003-64	2.9
3003-406	4.25	3003-66	2.10
3003-408	4.25	3003-67	2.8
3003-412	4.21	3003-68	2.10
3003-414	4.21	3003-69	2.13
3003-416	4.21	3003-70	2.12
3003-418	4.21	3003-710	3.13
3003-422	4.23	3003-712	3.13
3003-424	4.23	3003-714	3.13
3003-426	4.23	3003-716	3.13
3003-428	4.23	3003-72	2.12
3003-430	4.20	3003-720	3.9, 6.43
3003-432	4.20	3003-724	3.9
3003-434	4.20	3003-726	3.9
3003-436	4.22	3003-728	3.9
3003-438	4.22	3003-730	3.13
3003-440	4.22	3003-738	3.18
3003-442	4.22	3003-74	2.16
3003-450	4.19	3003-740	3.16
3003-452	4.19	3003-742	3.16
3003-454	4.19	3003-750	3.14
3003-46	2.8	3003-752	3.14
3003-462	4.24	3003-760	3.15
3003-464	4.24	3003-762	3.15
3003-466	4.24	3003-770	3.4, 6.34
3003-47	2.8	3003-774	3.4, 6.36
3003-510	4.13	3003-775	3.4, 6.36
3003-52	2.5	3003-776	3.4, 6.36
3003-530	4.13	3003-778	3.4, 6.34
3003-54	2.5	3003-779	3.4, 6.38
3003-540	4.13	3003-780	3.4
3003-540-12	4.13	3003-782	3.4
3003-550	4.18	3003-784	3.4



3003-786	3.4	3003-944	3.5
3003-79	2.14	3003-944	4.11
3003-794	3.18	3003-946	3.5
3003-80	2.15	3003-948	3.5
3003-800	6.31	3003-94A	4.11
3003-804	3.8	3003-952	3.6
3003-806	3.8	3003-954	3.6
3003-810	3.8, 6.34	3003-956	3.6
3003-816	3.8	3003-958	3.6
3003-818	3.8	3003-962	3.5
3003-82	2.15	3003-964	3.5
3003-820	3.8	3003-966	3.5
3003-823	3.19	3003-968	3.5
3003-825	3.19	3003-972	3.5
3003-832	3.19	3003-974	3.5
3003-84	2.15	3003-976	3.5
3003-840	3.20, 6.54	3003-978	3.5
3003-841	3.20, 6.54	3003-980	3.7
3003-842	3.20, 6.54	3003-984	3.7
3003-843	3.20	3003-985	3.7
3003-846	3.20	3003-986	3.7
3003-847	3.20	3003-988	3.7
3003-850	3.20	3003-989	3.7
3003-851	3.20, 6.54	3003-990	3.7
3003-86	2.15	3003-992	3.7
3003-866	4.26	3003-994	3.7
3003-868	4.26	3003-996	3.7
3003-870	4.26	301-0110	10.15
3003-872	4.26	301-0120	10.15
3003-88	2.16	301-0130	10.15
3003-90	4.11	3049-90	3.40
3003-902	3.2	3049-92	3.40
3003-904	3.2	3190-08	3.36
3003-906	3.2	3303-410	3.15
3003-908	3.2	3303-430	3.15
3003-90A	4.11	3303-434	3.15
3003-91	4.11	3303-452	3.10
3003-912	3.2	3303-470	3.10
3003-914	3.2	3303-472	3.10
3003-916	3.2	3303-603	4.14
3003-918	3.2	3303-622	4.14
3003-91A	4.11	3303-646	4.8
3003-922	3.2	3303-664	4.8
3003-924	3.2	3303-667	4.8
3003-926	3.2	3781-10	6.30
3003-928	3.2	3781-16	6.30
3003-93	4.11	3784-09	6.30
3003-932	3.3	3784-10	6.30
3003-934	3.3	3784-11	6.30
3003-936	3.3	3784-12	6.30
3003-938	3.3	3784-13	6.30
3003-93A	4.11	3784-14	6.32
3003-94	4.11	3784-15	6.32
3003-942	3.5	3784-30	6.32



INDEX

3784-31	6.32	3789-07	3.39
3784-32	6.32	3789-08	3.39
3784-33	6.32	3789-11	4.47
3784-40	6.30	3789-11T	4.26
3784-41	6.30	3789-12	4.47
3784-42	6.30	3789-13	4.47
3784-43	6.31	3789-14	4.47
3784-44	6.29	3789-14-3	4.47, 6.55
3784-45	6.29	3789-16	5.21
3784-451	6.29	3789-17	5.21
3784-80	6.29	3789-20	3.39, 6.41
3785-20	6.4	3795-01	6.6
3785-21	6.4	3795-01A	6.6
3785-22	6.4	3795-04	6.7
3785-24	6.4	3795-06	6.7
3785-26	6.4	3795-08	6.7
3785-27	6.4	3795-14	6.7
3785-41	6.4	3795-16	6.7
3785-42	6.4	3795-18	6.7
3785-43	6.4	3795-20	6.7
3786-20	6.4	3795-22	6.7
3786-21	6.4	3795-24	6.7
3786-22	6.4	3795-28	6.7
3786-23	6.4	3795-50	6.1, 6.3
3786-24	6.4	3795-51	6.1, 6.3
3786-25	6.4	3795-52	6.1, 6.3
3786-26	6.4	3795-54	6.1, 6.3
3786-27	6.4	3795-56	6.1, 6.3
3786-28	6.4	3795-57	6.1, 6.3
3786-29	6.4	4004-01	3.23
3786-30	6.5	4004-02	3.23
3786-31	6.5	4004-03	3.23
3786-32	6.5	4004-03-3A	3.23, 6.50
3786-40	6.5	4004-039	3.40
3786-41	6.4	4004-04	3.23
3786-42	6.4	4004-043	3.40
3786-43	6.4	4004-05	3.31
3788-01	5.23	4004-07	3.31
3788-02	5.23, 6.55	4004-108	3.36
3788-04	5.23	4004-124	3.36
3788-05	5.23	4004-125	3.36
3788-06	5.23	4004-17	3.31
3788-08	3.39	4004-185	6.13, 7.46
3788-10	3.39	4004-186	6.13, 7.46
3788-12	4.48	4004-189	6.13, 7.46
3788-13	4.48	4004-19	3.31
3788-14	4.48	4004-204	3.25
3788-15	4.48	4004-206	3.25
3788-27	5.23	4004-210	3.25
3788-29	5.23	4004-212	3.25
3789-01	5.21	4004-216	3.21
3789-02	5.21	4004-217	3.21
3789-03	5.21	4004-220	3.21
3789-04	5.21	4004-221	3.21



4004-224	3.21, 6.48	4004-47	3.32
4004-225	3.21	4004-48	3.32
4004-226	3.21	4004-50	3.32
4004-227	3.21	4004-50A	3.32
4004-228	3.21	4004-50B	3.32
4004-23	3.31	4004-52	3.32
4004-230	3.27	4004-54	3.32
4004-232	3.27	4004-56	3.38
4004-235	3.28	4004-57	3.38
4004-238	3.34	4004-59	3.38
4004-239	3.34	4004-62	3.35
4004-240	3.33	4004-63	3.35
4004-242	3.33	4004-65	3.30
4004-244	3.29	4004-76	3.33
4004-245	3.29	4004-77	3.33
4004-246	3.29	4004-79	3.33
4004-248	3.29	4004-79-12	3.33
4004-25	3.34	4004-80	3.30
4004-250	3.22	4004-84	3.30
4004-251	3.22	4004-86	3.30
4004-252	3.22	4004-88	3.30
4004-253	3.22	4004-90	3.30
4004-254	3.22	4004-92	3.30
4004-256	3.22	4004-94	3.30
4004-260	3.24	4004-95	3.25
4004-261	3.24	4004-96	3.25
4004-262	3.24	4004-97	3.26
4004-263	3.24	4004-97-3A	3.26, 6.52
4004-266	3.28	4004-97A	3.26
4004-268	3.28	4004-98	3.25
4004-269	3.28	4004-99	3.25
4004-27	3.34	4155-06	4.39
4004-270	3.27	4155-07	4.39
4004-272	3.27	4157-77	4.39
4004-28	3.34	4375-08	2.52
4004-280	3.22	4375-09	2.52
4004-282	3.22	4375-10	2.52
4004-29	3.34	4375-11	2.52
4004-305	3.28	4375-12	2.52
4004-31	3.35	4375-14	2.52
4004-320	3.21	4377-08	2.53, 6.42
4004-330	3.21	4377-09	2.53
4004-346	3.29	4377-11	2.53
4004-35	3.35	4377-12	2.53
4004-350	3.29	4377-28	2.54
4004-37	3.38, 6.48	4377-30	2.54
4004-394	3.37	4383-40	2.17, 6.45
4004-40	3.32	4383-42	2.17, 6.45
4004-42	3.32	4383-44	2.17, 6.45
4004-43	3.32	4383-46	2.17, 6.45
4004-44	3.32	4384-40	2.17, 6.45
4004-45	3.32	4384-42	2.17, 6.45
4004-45A	3.32	4384-44	2.17, 6.45
4004-46	3.32	4384-46	2.17, 6.45



INDEX

4385-40	2.17, 6.45	6006-128	4.29
4385-42	2.17, 6.45	6006-129	4.29
4385-44	2.17, 6.45	6006-130	4.29
4385-46	2.17, 6.45	6006-131	4.29
4447-07	2.51	6006-132	4.29
4447-09	2.51	6006-133	4.29
4545-09	2.55	6006-139	4.30
4635-06	2.55	6006-14	4.44
5005-00	2.45	6006-148	4.40
5005-001	2.45	6006-15	4.46
5005-01	2.46	6006-152	4.40
5005-02	2.46	6006-158	4.37
5005-03	2.46	6006-159	4.37
5005-05	2.46	6006-16	4.46
5005-13	2.48	6006-160	4.37
5005-15	2.48	6006-17	4.44
5005-23	2.48	6006-170	4.38
5005-25	2.48	6006-174	4.38
5005-33	2.48	6006-19	4.44
5005-35	2.48	6006-20	4.43
5005-37	2.48	6006-24	4.43
5005-39	2.48	6006-28	4.43
5005-43	2.49	6006-29	4.42
5005-45	2.49	6006-310	4.34
5005-47	2.50	6006-32	4.43
5005-49	2.50	6006-33	4.42
5005-51	2.50	6006-330	4.34
5005-53	2.50	6006-334	4.34
5005-60	2.45	6006-340	4.34
5005-62	2.45	6006-36	4.43
5005-64	2.45	6006-37	4.42
5005-80	2.44, 6.57, 6.59	6006-40	4.43
5005-82	2.46, 6.56, 6.58	6006-41	4.42
5005-86	2.47, 6.56, 6.58	6006-44	4.27
5005-88	2.47, 6.56, 6.58	6006-45	4.27
6006-02	4.42	6006-46	4.27
6006-04	4.41	6006-47	4.27
6006-05	4.46	6006-48	4.30
6006-08	4.44	6006-50	4.31
6006-10	4.44	6006-52	4.31
6006-100	4.38	6006-54	4.31
6006-102	4.38	6006-56	4.31
6006-104	4.38	6006-56-3	4.27, 6.51
6006-108	4.37	6006-58	4.36
6006-110	4.37	6006-59	4.32
6006-112	4.37	6006-61	4.32
6006-12	4.44	6006-610	4.45
6006-120	4.33	6006-62	4.36
6006-121	4.28	6006-620	4.45
6006-122	4.33	6006-63	4.32
6006-123	4.28	6006-630	4.45
6006-124	4.33	6006-65	4.32
6006-125	4.28	6006-70	4.35
6006-127	4.28	6006-72	4.35



6006-82	4.33	7007-218-1SC	5.34
6006-84	4.33	7007-218-2	5.35
6006-86	4.33	7007-218-2SC	5.35
6006-88	4.33	7007-218-3SC	5.34, 6.44
6006-90	4.36	7007-218SC	5.33
6006-92	4.36	7007-219SC	5.33
6006-94	4.36	7007-220	5.33
7007-02	5.45	7007-220-1	5.34
7007-06	5.45	7007-220-1SC	5.34
7007-104	5.7	7007-220-2SC	5.35
7007-105	5.7	7007-220SC	5.33
7007-106	5.7	7007-221SC	5.33
7007-108	5.7	7007-222	5.33
7007-110	5.7	7007-222-1	5.34
7007-112	5.16	7007-222-1SC	5.34
7007-116	5.16	7007-222-2SC	5.35
7007-120	5.19	7007-222SC	5.33
7007-124	5.19	7007-223-2SC	5.35
7007-126	5.19	7007-224	5.33
7007-128	5.9	7007-224-1SC	5.34
7007-130	5.9	7007-224-2SC	5.35
7007-132	5.9	7007-224SC	5.33
7007-134	5.9	7007-226-1SC	5.34
7007-140	5.15, 6.51, 6.53	7007-226SC	5.33
7007-167	5.24	7007-230SC	5.33
7007-168	5.24	7007-232SC	5.39
7007-200	5.42	7007-236	5.39
7007-200SC	5.42	7007-236SC	5.39
7007-202	5.42	7007-237	5.39
7007-202SC	5.42	7007-237SC	5.39
7007-204	5.38	7007-242	5.39
7007-204SC	5.38	7007-242SC	5.39
7007-205SC	5.38	7007-25	5.28
7007-206	5.38	7007-250	5.25
7007-206SC	5.38	7007-250-5	5.25
7007-207SC	5.38	7007-250-5SC	5.25
7007-208SC	5.30	7007-250SC	5.25
7007-210	5.30	7007-252	5.25
7007-210SC	5.30, 6.57, 6.59	7007-252-5	5.25
7007-211	5.30	7007-252-5SC	5.25
7007-211SC	5.30, 6.44	7007-252SC	5.25
7007-214	5.33	7007-254	5.25
7007-214SC	5.33	7007-254-5	5.25
7007-215-2	5.35	7007-254-5SC	5.25
7007-215-2SC	5.35	7007-254SC	5.25, 6.44
7007-216	5.33	7007-256	5.25
7007-216-1	5.34	7007-256-5	5.25
7007-216-1SC	5.34	7007-256-5SC	5.25
7007-216-2	5.35	7007-256SC	5.25
7007-216-2SC	5.35	7007-258	5.25
7007-216SC	5.33	7007-258-5	5.25
7007-217SC	5.33	7007-258-5SC	5.25
7007-218	5.33	7007-258SC	5.25
7007-218-1	5.34	7007-26	5.28



INDEX

7007-260	5.27	7007-402	5.11
7007-260SC	5.27	7007-403	5.11
7007-260-5	5.27	7007-404	5.11
7007-260-5SC	5.27	7007-40-5	5.26
7007-262SC	5.31, 6.35, 6.39	7007-410	5.16
7007-263SC	5.31	7007-411	5.13
7007-264	5.31	7007-412	5.16
7007-264SC	5.31	7007-413	5.13
7007-266SC	5.31	7007-414	5.16
7007-268	5.31	7007-415	5.13
7007-268SC	5.31	7007-416	5.16
7007-27	5.28	7007-417	5.13
7007-270SC	5.37	7007-418	5.16
7007-272SC	5.37	7007-419	5.13
7007-274	5.37	7007-42	5.26
7007-274SC	5.37	7007-420	5.6
7007-276SC	5.37	7007-421	5.3
7007-278	5.37	7007-422	5.6
7007-278SC	5.37	7007-423	5.3
7007-28	5.28	7007-424	5.6
7007-280SC	5.37	7007-425	5.3
7007-282SC	5.41	7007-42-5	5.26
7007-284SC	5.41	7007-426	5.6
7007-286	5.41	7007-427	5.3
7007-286SC	5.41	7007-428	5.6
7007-288SC	5.41	7007-429	5.3
7007-292SC	5.43	7007-44	5.26
7007-294	5.43	7007-440	5.14
7007-294SC	5.43	7007-440-8	5.14
7007-295	5.43	7007-442	5.14
7007-295SC	5.43	7007-442-8	5.14
7007-296SC	5.31	7007-444	5.14
7007-298SC	5.31	7007-444-8	5.14
7007-30	5.29	7007-44-5	5.26
7007-300	5.31	7007-446	5.14
7007-300SC	5.31	7007-446-8	5.14
7007-302SC	5.44	7007-448	5.14
7007-304SC	5.44	7007-448-8	5.14
7007-306SC	5.44	7007-449	5.13
7007-311SC	5.40	7007-449-8	5.13
7007-313	5.30	7007-450	5.17
7007-313SC	5.30	7007-452	5.17
7007-315	5.30	7007-453	5.17
7007-315SC	5.30	7007-454	5.17
7007-32	5.29	7007-456	5.17
7007-320	5.29	7007-458	5.17
7007-320SC	5.29, 6.44	7007-46	5.26
7007-33	5.29	7007-460	5.8
7007-34	5.29	7007-462	5.8
7007-35	5.29	7007-464	5.8
7007-395SC	5.44	7007-46-5	5.26
7007-397SC	5.44	7007-466	5.8
7007-40	5.26	7007-468	5.8
7007-401	5.11	7007-470	5.19



7007-479	5.18	7007-712	5.10
7007-48	5.26	7007-729	5.1
7007-481	5.18	7007-76	5.45
7007-483	5.18	7007-768	5.1
7007-485	5.18	7007-78	5.45
7007-48-5	5.26	7007-84	5.36
7007-487	5.18	8008-02	6.18
7007-490	5.4	8008-04	6.18
7007-490-8	5.4	8008-06	6.18
7007-492	5.4	8008-10	6.19
7007-492-8	5.4	8008-11	6.19
7007-494	5.4	8008-12	5.46
7007-494-8	5.4	8008-14	5.46
7007-496	5.4	8008-15	5.46
7007-496-8	5.4	8008-230	6.14, 6.56, 6.58
7007-498	5.4	8008-232	6.14, 6.57, 6.59
7007-499	5.5	8008-236	6.14, 6.56, 6.58
7007-499-8	5.5	8008-400	6.10
7007-50	5.27	8008-405	6.10
7007-50-5	5.27	8008-41	6.25
7007-506	5.20, 6.38	8008-410	6.11
7007-507	5.20, 6.38	8008-42	6.25
7007-508	5.22	8008-420	6.11
7007-509	5.22	8008-420-4	6.11
7007-510	5.22	8008-43	6.24
7007-511	5.22, 6.35	8008-430	6.11
7007-514	5.22, 6.37	8008-432	6.11
7007-521	5.22, 6.35	8008-448A	6.12
7007-522	5.22, 6.37	8008-448B	6.12
7007-538	5.11	8008-448C	6.12
7007-539	5.11	8008-449A	6.12
7007-540	5.12	8008-449B	6.12
7007-540-8	5.12	8008-449C	6.12
7007-542	5.12	8008-45	6.26
7007-542-8	5.12	8008-452	6.12
7007-544	5.12	8008-454	6.12
7007-544-8	5.12	8008-456	6.12
7007-546	5.12	8008-458	6.12
7007-546-8	5.12	8008-460	6.12
7007-548	5.12	8008-462	6.12
7007-56	5.32	8008-464	6.12
7007-58	5.32	8008-466	6.12
7007-590	5.2	8008-468	6.12
7007-590-8	5.2	8008-47	6.26
7007-592	5.2	8008-472	6.12
7007-592-8	5.2	8008-474	6.12
7007-594	5.2	8008-476	6.12
7007-594-8	5.2	8008-478	6.12
7007-596	5.2	8008-480	6.12
7007-596-8	5.2	8008-482	6.12
7007-598	5.2	8008-484	6.12
7007-60	5.32	8008-486	6.12
7007-62	5.32	8008-488	6.12
7007-64	5.32	8008-493	6.12



INDEX

8008-494	6.12	9009-216	7.14
8008-495	6.12	9009-217	7.14
8008-81	6.27	9009-22	10.4
8008-903	6.21	9009-220	7.12
8008-905	6.22	9009-221	7.12
8008-911	6.21	9009-222	7.12
8008-912	6.21	9009-223	7.12
8008-913	6.22	9009-225	7.12
8008-914	6.22	9009-226	7.8
8008-915	6.23	9009-227	7.7
8008-931L	6.21	9009-228	7.7
8008-931R	6.21	9009-229	7.6
8008-932L	6.21	9009-23	10.4
8008-932R	6.21	9009-230	7.5
8008-933L	6.22	9009-237	7.6
8008-933R	6.22	9009-24	10.4, 10.6, 10.7
8008-934L	6.22	9009-240	7.21
8008-934R	6.22	9009-241	7.21
8008-935L	6.23	9009-250	7.18
8008-935R	6.23	9009-251	7.18
8888-901	6.21	9009-252	7.18
8888-902	6.21	9009-253	7.18
8888-903	6.22	9009-26	10.7
8888-904	6.22	9009-270	7.19
8888-905	6.23	9009-274	7.19
9009-100	6.28	9009-275	7.19
9009-104	6.28	9009-280	7.16
9009-106	6.28	9009-281	7.16
9009-110	6.28	9009-282	7.16
9009-120	6.15	9009-283	7.16
9009-121	6.15	9009-284	7.15
9009-122	6.15	9009-285	7.15
9009-123	6.15	9009-286	7.15
9009-126	5.47	9009-287	7.15
9009-128	5.47	9009-290	7.12
9009-13	10.4, 10.6	9009-300	7.3
9009-14	10.4, 10.6, 10.7	9009-301	7.3
9009-142	6.31, 6.48	9009-302	7.2
9009-144	6.28, 6.45, 6.48	9009-303	7.2
9009-146	6.28, 6.45, 6.48	9009-310	7.3
9009-148	2.44, 6.42, 6.48	9009-311	7.3
9009-15	10.4, 10.6	9009-312	7.2
9009-150	6.33, 6.49	9009-313	7.2
9009-152	6.33, 6.49	9009-360	6.40
9009-16	10.4	9009-364	6.40
9009-18	10.4	9009-380	6.40
9009-20	10.4	9009-393	6.2, 6.3
9009-21	10.4	9009-395	6.2, 6.3
9009-210	7.14	9009-420	7.29
9009-211	7.14	9009-422	7.29
9009-212	7.14	9009-500	7.29
9009-213	7.14	9009-506	10.11
9009-214	7.14	9009-506A	10.11
9009-215	7.14	9009-510	7.28



9009-511	7.28	9009-827-15	7.38
9009-512	7.28	9009-828	7.38
9009-513	7.28	9009-828-15	7.38
9009-516	7.28	9009-828-16	7.38
9009-517	7.28	9009-838SC	7.39
9009-520	7.28	9009-840SC	7.39
9009-521	7.28	9009-842SC	7.39
9009-522	7.28	9009-900	7.42
9009-523	7.28	9009-901	7.42
9009-524	7.28	9009-905	7.43
9009-525	7.28	9009-908	7.40
9009-528	7.27	9009-909	7.40
9009-530	7.27	9009-910	7.40
9009-532	7.27	9009-911	7.40
9009-540	7.35	9009-912	7.40
9009-541	7.35	9009-913	7.40
9009-542	7.35	9009-914	7.41
9009-543	7.35	9009-915	7.41
9009-550	7.35	9009-916	7.41
9009-551	7.35	9009-917	7.41
9009-552	7.35	9009-920	7.43
9009-553	7.35	9009-921	7.43
9009-560	7.36	9009-922	7.43
9009-561	7.36	9009-924	7.43
9009-562	7.36	9009-925	7.43
9009-563	7.36	9009-928	6.8
9009-570	7.36	9009-928-3	6.8
9009-571	7.36	9009-929	6.8
9009-572	7.36	9009-929-3	6.8
9009-573	7.36	9009-930	6.8
9009-618	7.31	9009-934	6.8
9009-636	7.32	9009-940	6.8
9009-637	7.32	9009-941	6.8, 6.9
9009-638	7.32	9009-942	6.8, 6.9
9009-639	7.32	9009-943	6.8, 6.9
9009-640	7.33	9009-944	6.8, 6.9
9009-642	7.33	9009-945	6.8, 6.9
9009-644	7.33	9009-947	6.8, 6.9
9009-645	7.33	9009-949	6.8, 6.9
9009-648	7.30	9009-950	6.8
9009-650	7.30	9009-951	6.8, 6.9
9009-710SC	7.26	9009-952	6.8, 6.9
9009-716SC	6.41, 7.25	9009-953	6.8, 6.9
9009-718SC	6.41, 7.25	9009-954	6.8, 6.9
9009-738SC	7.25	9009-955	6.8, 6.9
9009-816	7.47	9009-957	6.8, 6.9
9009-820	7.47	9009-959	6.8, 6.9
9009-823-14	7.45	9009-960	6.8
9009-823-17	7.45	9009-961	6.8, 6.9
9009-826-14	7.37	9009-962	6.8, 6.9
9009-826-17	7.37	9009-963	6.8, 6.9
9009-827-11	7.38	9009-964	6.8, 6.9
9009-827-12	7.38	9009-965	6.8, 6.9
9009-827-13	7.38	9009-967	6.8, 6.9



INDEX

9009-9696.8, 6.9	9019-750-25SC	8.5
9009-9706.8	9909-202	7.17
9009-9716.8, 6.9	9909-203	7.17
9009-9726.8, 6.9	9909-219	7.20
9009-9736.8, 6.9	9909-221	7.20
9009-9746.8, 6.9	9909-222	7.20
9009-9756.8, 6.9	9909-224	7.18
9009-9776.8, 6.9	9909-225	7.18
9009-9796.8, 6.9	9909-226	7.18
9009-9806.8	9909-227	7.18
9009-9816.8, 6.9	9909-232	7.22
9009-9826.8, 6.9	9909-234	7.24
9009-9836.8, 6.9	9909-610	7.34
9009-9846.8, 6.9	9909-612	7.34
9009-9856.8, 6.9	9909-900	7.44
9009-9876.8, 6.9	9909-902	7.44
9009-9896.8, 6.9	9909-904	7.44
9009-9906.8	9909-910SC	7.26
9009-9916.8, 6.9	9909-911SC	7.26
9009-9926.8, 6.9	9909-912	7.22
9009-9936.8, 6.9	9909-912-13	7.22
9009-9946.8, 6.9	9909-913	7.24
9009-9956.8, 6.9	9909-914	7.23
9009-9976.8, 6.9	9909-915	7.23
9009-9996.8, 6.9	9909-919	7.9
9019-420-17	8.1	9909-920	7.10
9019-420-25	8.1	9909-920-1	7.10
9019-430-17	8.1	9909-921	7.7
9019-430-25	8.1	9909-922	7.7
9019-440-17	8.1	9909-923	7.9
9019-440-25	8.1	9909-924	7.10
9019-610-17	8.2	9909-925	7.10
9019-610-25	8.2	9909-926	7.11
9019-614-17	8.2	9909-927	7.11
9019-614-25	8.2	9909-928	7.11
9019-630-17	8.2	9909-940	7.13
9019-630-25	8.2	9909-946	7.4
9019-640-17	8.3	9909-947	7.4
9019-640-25	8.3	9999-100	6.34
9019-710-17SC	8.4	9999-101	6.36
9019-710-25SC	8.4	9999-102	6.38
9019-715-17SC	8.4	9999-109	6.40
9019-715-25SC	8.4	9999-150	6.56
9019-720-17SC	8.4	9999-151	6.58
9019-720-25SC	8.4	9999-162	6.50
9019-722-17SC	8.4	9999-163	6.52
9019-722-25SC	8.4	9999-164	6.54
9019-724-17SC	8.4	9999-166	6.50, 6.52, 6.54
9019-724-25SC	8.4	9999-181	6.42
9019-740-17SC	8.5	9999-192	6.48
9019-740-25SC	8.5		
9019-748-17SC	8.5		
9019-748-25SC	8.5		
9019-750-17SC	8.5		



WARRANTY

SCANLAN® Instrumentation is guaranteed to be free from defects in materials and workmanship for ten full years. Any instrument which proves defective when used for its intended purpose will be repaired or replaced at no charge, at the sole discretion of Scanlan International, Inc. This warranty is in lieu of all other warranties, either expressed or implied.

In no event shall seller be liable to buyer, or any successors of buyer, for any claim for lost opportunity, loss of goodwill, or consequential or incidental damages of any kind for any amount in excess of the price of the product. Seller agrees to replace or to issue credit at seller's sole option any product determined to be defective in materials or workmanship. Seller shall not be responsible for the cost of labor or charges of any kind incurred due to product defect. Your rights under this warranty may vary from state to state and country to country. **IMPORTANT: All SCANLAN® instruments must be returned to Scanlan International for refurbishment. Refurbishment of Scanlan instrumentation by any other resource will void the Scanlan warranty.**

SCANLAN® V.I.P.™ Instrument Sterilization Trays: SCANLAN® V.I.P.™ instrument sterilization trays are warranted for 12 months against defects in material or workmanship.

SCANLAN® DIAMOND DUST™ Instrumentation: SCANLAN® DIAMOND DUST™ jaws are guaranteed for 12 months. If needed, the DIAMOND DUST™ surface will be restored at no charge during the initial 12 month period.

Needle Holders: The use of suture needles larger than those recommended may result in damage and invalidate your warranty.

Titanium Instrumentation: Different shades of blue may be found within the extensive line of anodized SCANLAN® titanium instrumentation. This is not a defect, but a phenomenon which occurs due to slight variations of manufacture technique or alloy composition. This is a cosmetic characteristic only and does not compromise the high quality of your SCANLAN® titanium instrumentation.

Scissors: Do not cut suture, gauze, or wire with scissors unless it was designed to cut those materials. All SCANLAN® Super Cut™ & Ultra Sharp® scissors must be returned to Scanlan International for complete refurbishment and sharpening in order to maintain the unique cutting edge.

SCANLAN® Premier™ Scissors: Sharpness of SCANLAN® Premier™ Scissors is guaranteed for 12 months. If needed, resharpening will be performed at no charge during the 12 month period.

Heifetz™ Clips, Yasargil Clips: Product in the original packaging may be returned for full credit within 60 days domestic and 90 days international of invoice date. All used product will be considered FIRM SALE. Warranted for 12 months against defects in material or workmanship.

Reliance Bulldog Clamp: Warranty for materials and workmanship is one year. All sales are considered FIRM SALE.

SCANLAN® Scanturian™ Minimally Invasive Surgical Instrumentation is guaranteed to be free from defects in materials and workmanship for five full years. Any instrument which proves defective when used for its intended purpose will be repaired or replaced at no charge, at the sole discretion of Scanlan International, Inc. This warranty is in lieu of all other warranties, either expressed or implied.

PLEASE NOTE: Instrument designs may change without prior notice. We are proud of the handcrafted quality of our instruments, which can cause slight variations in instrument patterns.





Highest Quality Surgical Instrumentation



For more
information or
to place an
order

Please contact
your local Scanlan
representative for
products available
in your area, or
call...

U.S. & Canada
800-328-9458

International
651-298-0997



Since 1921

SCANLAN ★

INTERNATIONAL

Surgical products designed and manufactured by the Scanlan family since 1921

ONE SCANLAN PLAZA • SAINT PAUL, MINNESOTA 55107 • U.S.A.
800-328-9458 • 651-298-0997 • FAX 651-298-0018 • www.scanlaninternational.com

MK-CAT-2021
©2021 Scanlan International, Inc.